



PHYSICS

9702/12

Paper 1 Multiple Choice

May/June 2012

1 hour

Additional Materials: Multiple Choice Answer Sheet
Soft clean eraser
Soft pencil (type B or HB is recommended)

* 5 8 6 2 8 6 8 4 7 5 *

READ THESE INSTRUCTIONS FIRST

Write in soft pencil.

Do not use staples, paper clips, highlighters, glue or correction fluid.

Write your name, Centre number and candidate number on the Answer Sheet in the spaces provided unless this has been done for you.

There are **forty** questions on this paper. Answer **all** questions. For each question there are four possible answers **A, B, C** and **D**.

Choose the **one** you consider correct and record your choice in **soft pencil** on the separate Answer Sheet.

Read the instructions on the Answer Sheet very carefully.

Each correct answer will score one mark. A mark will not be deducted for a wrong answer.

Any working should be done in this booklet.

bestexamhelp.com

This document consists of **27** printed pages and **1** blank page.



Data

speed of light in free space,	$c = 3.00 \times 10^8 \text{ m s}^{-1}$
permeability of free space,	$\mu_0 = 4\pi \times 10^{-7} \text{ H m}^{-1}$
permittivity of free space,	$\epsilon_0 = 8.85 \times 10^{-12} \text{ F m}^{-1}$ $(\frac{1}{4\pi\epsilon_0} = 8.99 \times 10^9 \text{ m F}^{-1})$
elementary charge,	$e = 1.60 \times 10^{-19} \text{ C}$
the Planck constant,	$h = 6.63 \times 10^{-34} \text{ J s}$
unified atomic mass constant,	$u = 1.66 \times 10^{-27} \text{ kg}$
rest mass of electron,	$m_e = 9.11 \times 10^{-31} \text{ kg}$
rest mass of proton,	$m_p = 1.67 \times 10^{-27} \text{ kg}$
molar gas constant,	$R = 8.31 \text{ J K}^{-1} \text{ mol}^{-1}$
the Avogadro constant,	$N_A = 6.02 \times 10^{23} \text{ mol}^{-1}$
the Boltzmann constant,	$k = 1.38 \times 10^{-23} \text{ J K}^{-1}$
gravitational constant,	$G = 6.67 \times 10^{-11} \text{ N m}^2 \text{ kg}^{-2}$
acceleration of free fall,	$g = 9.81 \text{ m s}^{-2}$

Formulae

uniformly accelerated motion,

$$s = ut + \frac{1}{2}at^2$$

$$v^2 = u^2 + 2as$$

work done on/by a gas,

$$W = p\Delta V$$

gravitational potential,

$$\phi = -\frac{Gm}{r}$$

hydrostatic pressure,

$$p = \rho gh$$

pressure of an ideal gas,

$$p = \frac{1}{3} \frac{Nm}{V} \langle c^2 \rangle$$

simple harmonic motion,

$$a = -\omega^2 x$$

velocity of particle in s.h.m.,

$$v = v_0 \cos \omega t$$

$$v = \pm \omega \sqrt{x_0^2 - x^2}$$

electric potential,

$$V = \frac{Q}{4\pi\epsilon_0 r}$$

capacitors in series,

$$1/C = 1/C_1 + 1/C_2 + \dots$$

capacitors in parallel,

$$C = C_1 + C_2 + \dots$$

energy of charged capacitor,

$$W = \frac{1}{2}QV$$

resistors in series,

$$R = R_1 + R_2 + \dots$$

resistors in parallel,

$$1/R = 1/R_1 + 1/R_2 + \dots$$

alternating current/voltage,

$$x = x_0 \sin \omega t$$

radioactive decay,

$$x = x_0 \exp(-\lambda t)$$

decay constant,

$$\lambda = \frac{0.693}{t_{\frac{1}{2}}}$$

1 What is the unit watt in terms of SI base units?

- A Js^{-1} B $\text{m}^2\text{kg s}^{-1}$ C $\text{m}^2\text{kg s}^{-3}$ D Nms^{-1}

2 For which quantity is the magnitude a reasonable estimate?

- A frequency of a radio wave 500 pHz
 B mass of an atom 500 μg
 C the Young modulus of a metal 500 kPa
 D wavelength of green light 500 nm

3 A vector has magnitude R and perpendicular components P and Q , as shown in the diagram.

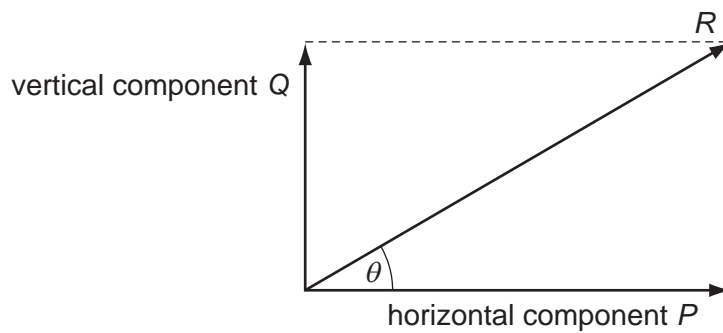

Which row correctly describes the perpendicular components?

	vertical component	horizontal component
A	Q	$R \sin \theta$
B	$R \cos \theta$	P
C	$R \cos \theta$	$R \sin \theta$
D	$R \sin \theta$	$R \cos \theta$

Space for working

- 4 The diameter of a cylindrical metal rod is measured using a micrometer screw gauge.

The diagram below shows an enlargement of the scale on the micrometer screw gauge when taking the measurement.

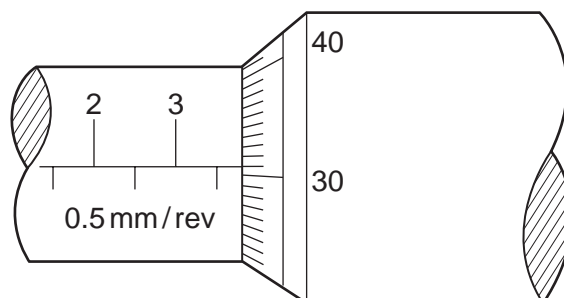

What is the cross-sectional area of the rod?

- A** 3.81 mm^2 **B** 11.4 mm^2 **C** 22.8 mm^2 **D** 45.6 mm^2
- 5 A mass is dropped from rest, and falls through a distance of 2.0 m in a vacuum. An observer records the time taken for the mass to fall through this distance using a manually operated stopwatch and repeats the measurements a further two times. The average result of these measured times, displayed in the table below, was used to determine a value for the acceleration of free fall. This was calculated to be 9.8 m s^{-2} .

	first measurement	second measurement	third measurement	average
time/s	0.6	0.73	0.59	0.64

Which statement best relates to the experiment?

- A** The measurements are precise and accurate with no evidence of random errors.
- B** The measurements are not accurate and not always recorded to the degree of precision of the measuring device but the calculated experimental result is accurate.
- C** The measurements are not always recorded to the degree of precision of the measuring device but are accurate. Systematic errors may be present.
- D** The range of results shows that there were random errors made but the calculated value is correct so the experiment was successful.

Space for working

- 6 The diagram shows two complete pulses on the screen of a cathode-ray oscilloscope. A grid of 1 cm squares covers the screen. The time-base setting is $1 \mu\text{s cm}^{-1}$.

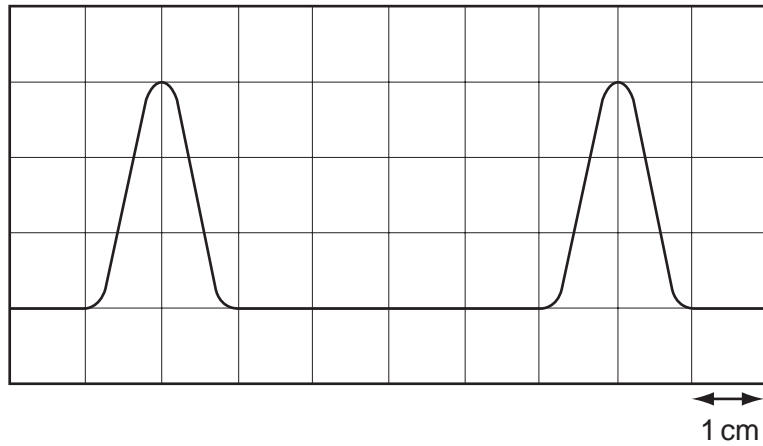

How long does each pulse last?

- A** $2 \mu\text{s}$ **B** $3 \mu\text{s}$ **C** $4 \mu\text{s}$ **D** $6 \mu\text{s}$

Space for working

- 7 The graph shows how the velocity v of an object moving in a straight line varies over time $t = 0$ to $t = T$.

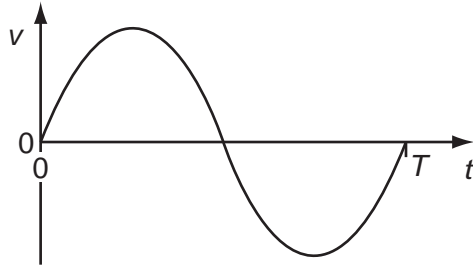

Which graph represents the displacement s of the object in the time $t = 0$ to $t = T$?

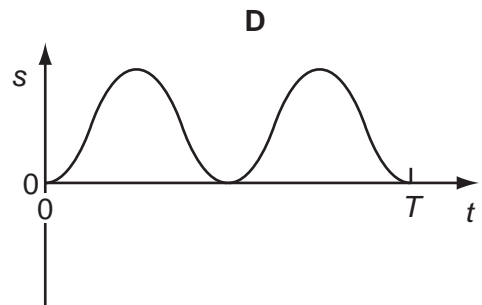
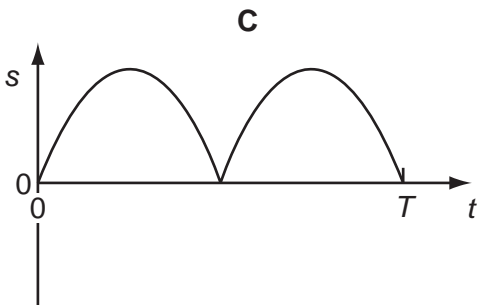
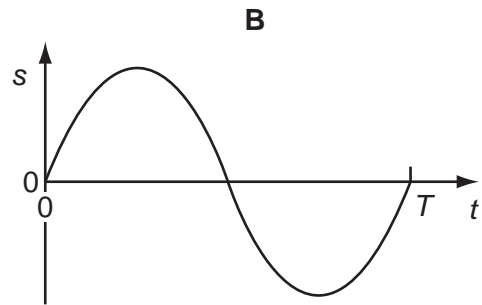
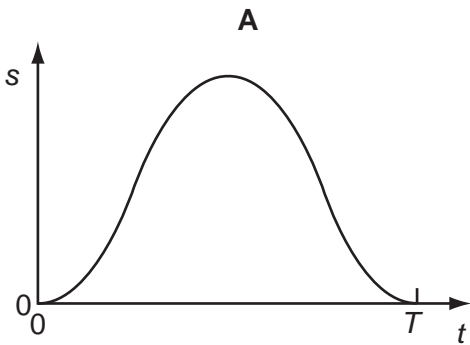

Space for working

- 8 Two markers M_1 and M_2 are set up a vertical distance h apart.

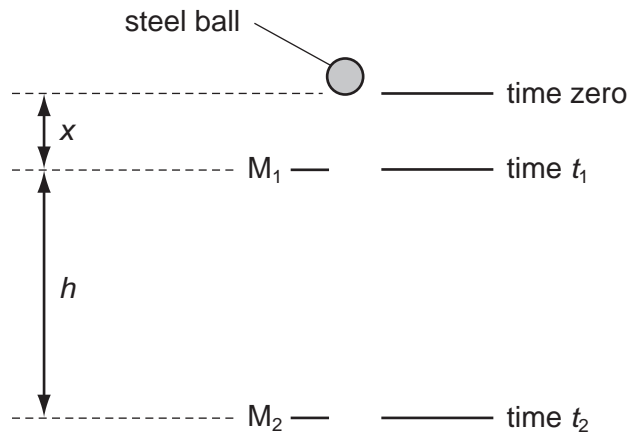

A steel ball is released at time zero from a point a distance x above M_1 . The ball reaches M_1 at time t_1 and reaches M_2 at time t_2 . The acceleration of the ball is constant.

Which expression gives the acceleration of the ball?

- A $\frac{2h}{t_2^2}$ B $\frac{2h}{(t_2 + t_1)}$ C $\frac{2h}{(t_2 - t_1)^2}$ D $\frac{2h}{(t_2^2 - t_1^2)}$

- 9 A brick is dislodged from a building and falls vertically under gravity.

Which graph best represents the variation of its height h above the ground with time t if air resistance is negligible?

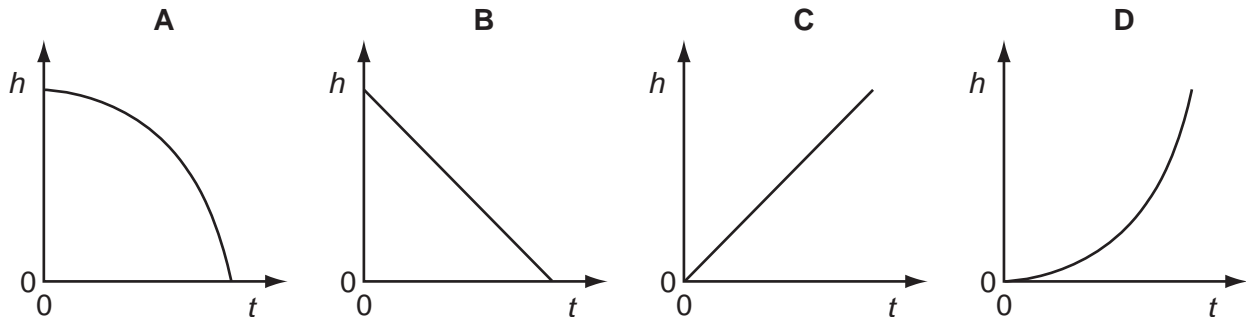

Space for working

- 10 A projectile is launched at point O and follows the path OPQRS, as shown. Air resistance may be neglected.

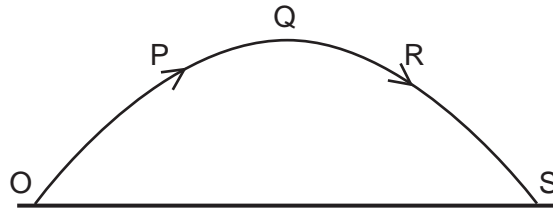

Which statement is true for the projectile when it is at the highest point Q of its path?

- A** The horizontal component of the projectile's acceleration is zero.
B The horizontal component of the projectile's velocity is zero.
C The kinetic energy of the projectile is zero.
D The momentum of the projectile is zero.
- 11 Which row correctly states whether momentum and kinetic energy are conserved in an inelastic collision in which there are no external forces?

	momentum	kinetic energy
A	conserved	conserved
B	conserved	not conserved
C	not conserved	conserved
D	not conserved	not conserved

Space for working

- 12 Two spheres approach each other along the same straight line. Their speeds are u_1 and u_2 before collision. After the collision, the spheres separate with speeds v_1 and v_2 in the directions shown below.



Which equation must be correct if the collision is perfectly elastic?

- A $u_1 - u_2 = v_2 + v_1$
 B $u_1 - u_2 = v_2 - v_1$
 C $u_1 + u_2 = v_2 + v_1$
 D $u_1 + u_2 = v_2 - v_1$
- 13 A box of mass 8.0 kg rests on a horizontal, rough surface. A string attached to the box passes over a smooth pulley and supports a 2.0 kg mass at its other end.

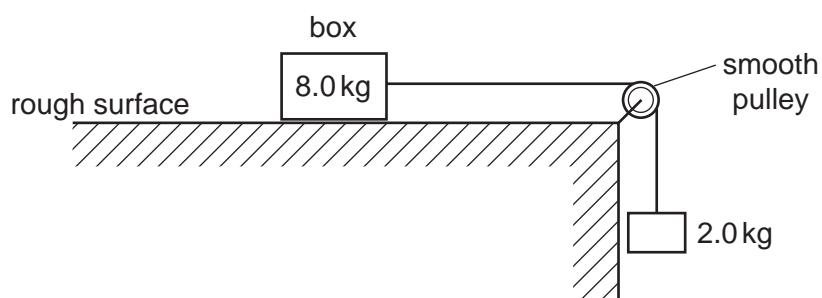

When the box is released, a frictional force of 6.0 N acts on it.

What is the acceleration of the box?

- A 1.4 ms^{-2} B 1.7 ms^{-2} C 2.0 ms^{-2} D 2.5 ms^{-2}

Space for working

- 14 A ladder is positioned on icy (frictionless) ground and is leant against a rough wall. At the instant of release it begins to slide.

Which diagram correctly shows the directions of the forces P , W and R acting on the ladder as it begins to slide?

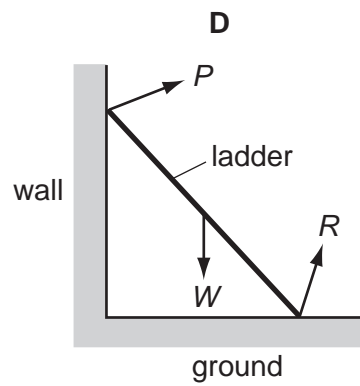
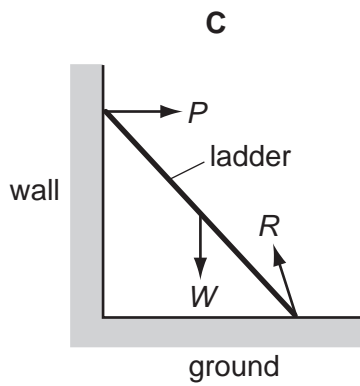
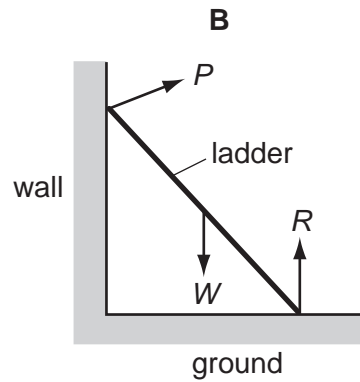
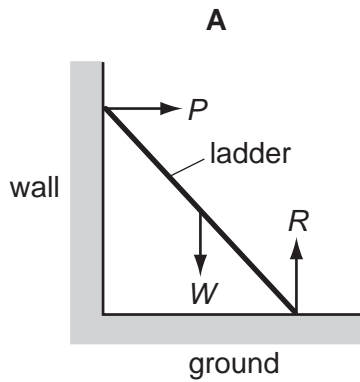

Space for working

- 15 The diagram shows a solid cube with weight W and sides of length L . It is supported by a frictionless spindle that passes through the centres of two opposite vertical faces. One of these faces is shaded.

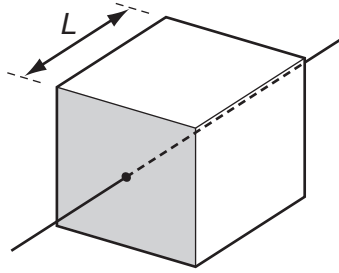

The spindle is now removed and replaced at a distance $\frac{L}{4}$ to the right of its original position.

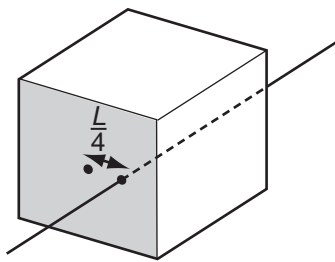

When viewing the shaded face, what is the torque of the couple that will now be needed to stop the cube from toppling?

- A $\frac{WL}{2}$ anticlockwise
- B $\frac{WL}{2}$ clockwise
- C $\frac{WL}{4}$ anticlockwise
- D $\frac{WL}{4}$ clockwise

Space for working

16 A sphere is released from rest in a viscous fluid.

Which graph represents the variation with time t of the acceleration a of the sphere?

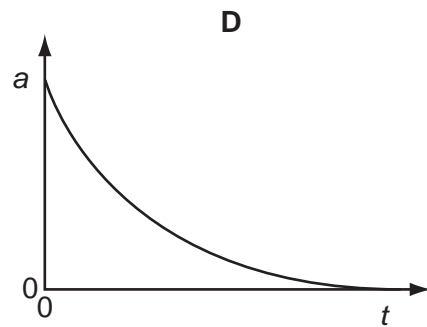
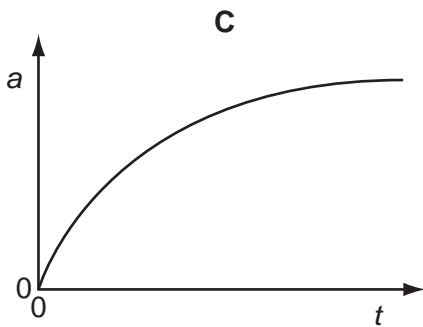
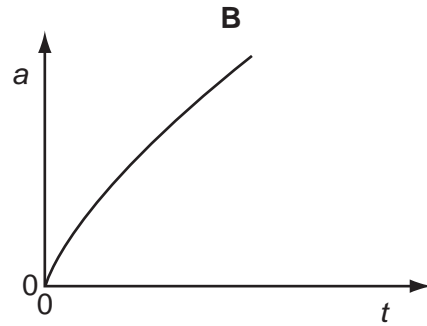
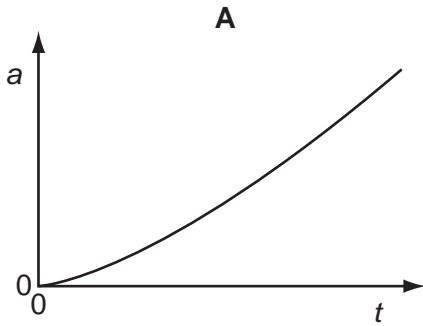

17 Initially, four identical uniform blocks, each of mass m and thickness h , are spread on a table.



How much work is done on the blocks in stacking them on top of one another?

- A** $3mgh$ **B** $6mgh$ **C** $8mgh$ **D** $10mgh$

Space for working

- 18 The diagram shows the design of a water wheel which drives a generator to produce electrical energy. The flow rate of the water is 200 kg s^{-1} . The generator supplies a current of 32 A at a voltage of 230 V.

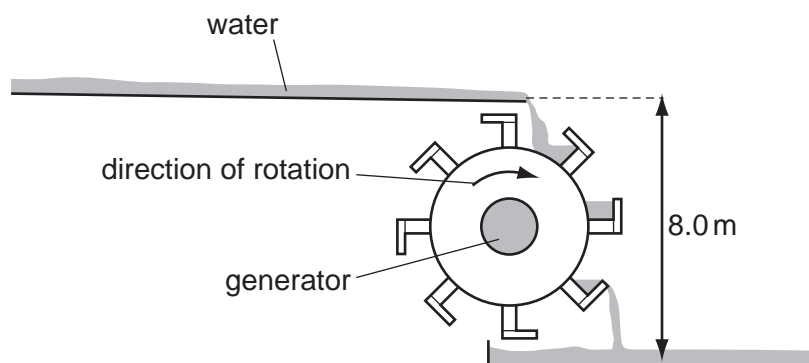

Ignoring any changes in kinetic energy of the water, what is the efficiency of the system?

- A 14% B 16% C 22% D 47%
- 19 A car engine exerts an average force of 500 N in moving the car 1.0 km in 200 s.
- What is the average power developed by the engine?
- A 2.5 W B 2.5 kW C 100 kW D 100 MW
- 20 A mass of gas enclosed in a cylinder by a piston is heated gently. At the same time, the piston is moved so that the pressure remains constant.
- As a result of this, what will **not** occur?
- A The average velocity of the molecules will increase.
 B The mean separation of the molecules will increase.
 C The molecules will travel greater distances between collisions.
 D The number of collisions per second of the molecules on the piston will increase.

Space for working

- 21 In an experiment to demonstrate Brownian motion, a transparent container is filled with smoke particles suspended in air.

What can be seen when the contents of the container are strongly illuminated and viewed through a microscope?

- A air molecules that are colliding with smoke particles
 - B air molecules that are moving in straight lines
 - C smoke particles that are moving in random zigzag paths
 - D smoke particles that are moving in straight lines
- 22 The diagram shows the arrangement of atoms in a particular crystal.

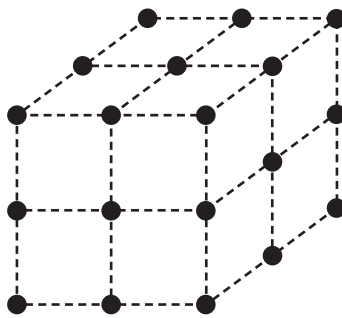

Each atom is at the corner of a cube.

The mass of each atom is 3.5×10^{-25} kg. The density of the crystal is 9.2×10^3 kg m⁻³.

What is the shortest distance between the centres of two adjacent atoms?

- A 3.8×10^{-29} m
- B 6.2×10^{-15} m
- C 3.4×10^{-10} m
- D 3.0×10^{-9} m

Space for working

23 A pipe is closed at one end and contains gas, trapped by a column of water.

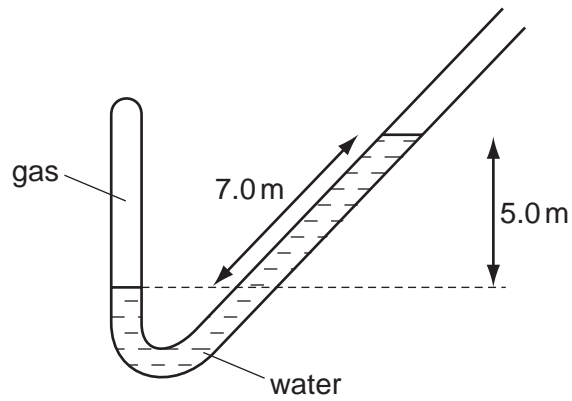

The atmospheric pressure is 1.0×10^5 Pa. The density of water is 1000 kg m^{-3} .

What is the pressure of the gas? (Use $g = 10 \text{ m s}^{-2}$.)

- A 0.3×10^5 Pa
- B 0.5×10^5 Pa
- C 1.5×10^5 Pa
- D 1.7×10^5 Pa

Space for working

24 The graph is a force-extension graph for a wire that is being stretched.

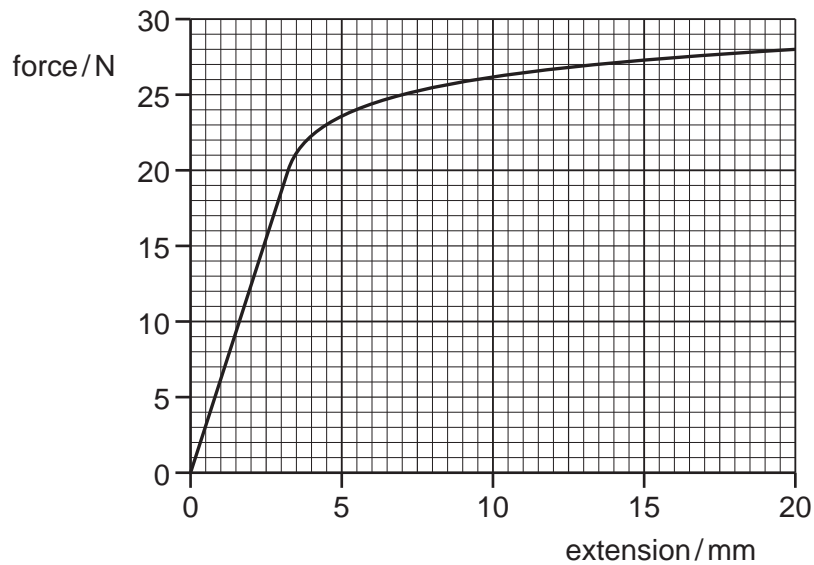

How much work needs to be done by the tensile force, to two significant figures, to cause an extension of 7.0 mm?

- A** 0.088 J **B** 0.12 J **C** 0.53 J **D** 120 J

25 A wire stretches 8 mm under a load of 60 N.

A second wire of the same material, with half the diameter and a quarter of the original length of the first wire, is stretched by the same load.

Assuming that Hooke's law is obeyed, what is the extension of this wire?

- A** 1 mm **B** 4 mm **C** 8 mm **D** 16 mm

Space for working

26 A surveyor's device emits a laser pulse.

What is the time taken for the pulse to travel from the device to a wall 150 m away, where it is reflected, and then return to the device?

- A** 0.05 ns **B** 0.10 ns **C** 0.50 μs **D** 1.0 μs

27 The period of an electromagnetic wave is 1.0 ns.

What are the frequency and wavelength of the wave?

	frequency / Hz	wavelength / m
A	1.0	3.0×10^8
B	1.0×10^6	300
C	1.0×10^9	0.30
D	1.0×10^{12}	3.0×10^{-4}

28 X and Y are two points on the surface of water in a ripple tank. A source of waves of constant frequency begins to generate waves which then travel past X and Y, causing them to oscillate.

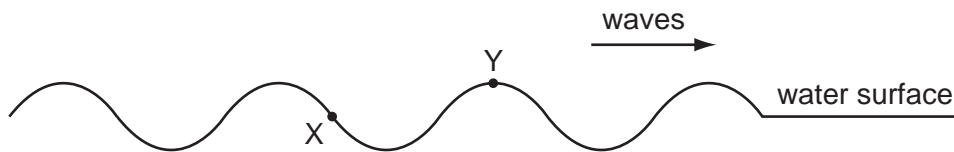

What is the phase difference between X and Y?

- A** 45° **B** 135° **C** 180° **D** 270°

Space for working

29 A monochromatic plane wave of speed c and wavelength λ is diffracted at a small aperture.

The diagram illustrates successive wavefronts.

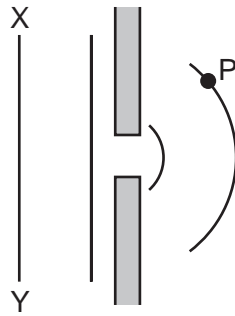

After what time will some portion of the wavefront XY reach point P?

A $\frac{3\lambda}{2c}$

B $\frac{2\lambda}{c}$

C $\frac{3\lambda}{c}$

D $\frac{4\lambda}{c}$

Space for working

30 A standing sound wave is set up between a loudspeaker and a wall.

A microphone is connected to a cathode-ray oscilloscope (c.r.o.) and is moved along a line directly between the loudspeaker and the wall. The amplitude of the trace on the c.r.o. rises to a maximum at a position X, falls to a minimum and then rises once again to a maximum at a position Y.

The distance between X and Y is 33 cm. The speed of sound in air is 330 m s^{-1} .

Which diagram represents the c.r.o. trace of the sound received at X?

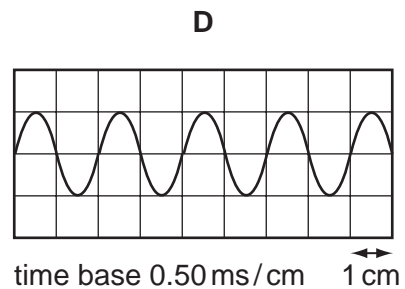
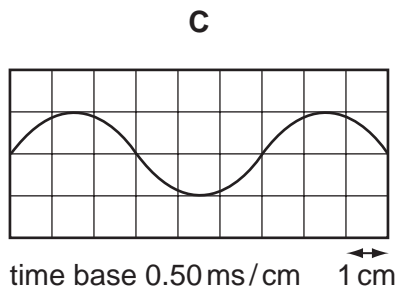
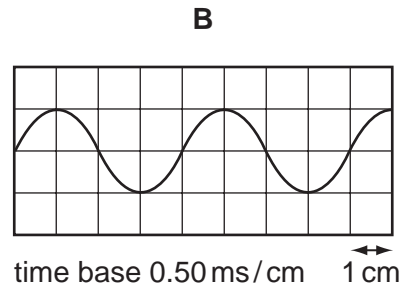
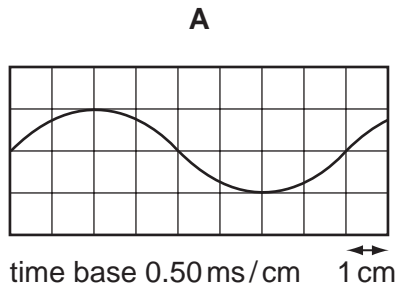

Space for working

31 An electric field exists in the space between two charged metal plates.

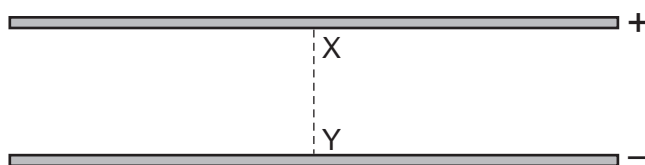

Which graph shows the variation of electric field strength E with distance d from X along the line XY?

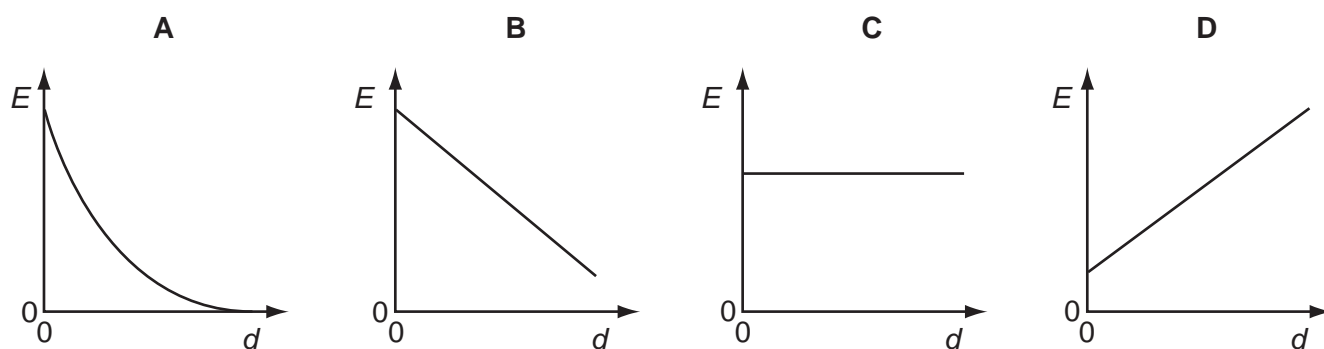

32 When will 1 C of charge pass a point in an electrical circuit?

- A when 1 A moves through a potential difference of 1 V
- B when a power of 1 W is used for 1 s
- C when the current is 5 mA for 200 s
- D when the current is 10 A for 10 s

Space for working

33 Two copper wires of the same length but different diameters carry the same current.

Which statement about the flow of charged particles through the wires is correct?

- A Charged particles are provided by the power supply. Therefore the speed at which they travel depends only on the voltage of the supply.
- B The charged particles in both wires move with the same average speed because the current in both wires is the same.
- C The charged particles move faster through the wire with the larger diameter because there is a greater volume through which to flow.
- D The charged particles move faster through the wire with the smaller diameter because it has a larger potential difference applied to it.

34 A power cable X has resistance R and carries current I .

A second cable Y has resistance $2R$ and carries current $\frac{1}{2}I$.

What is the ratio $\frac{\text{power dissipated in Y}}{\text{power dissipated in X}}$?

- A $\frac{1}{4}$ B $\frac{1}{2}$ C 2 D 4

Space for working

35 The diagram shows a circuit with four voltmeter readings V , V_1 , V_2 and V_3 .

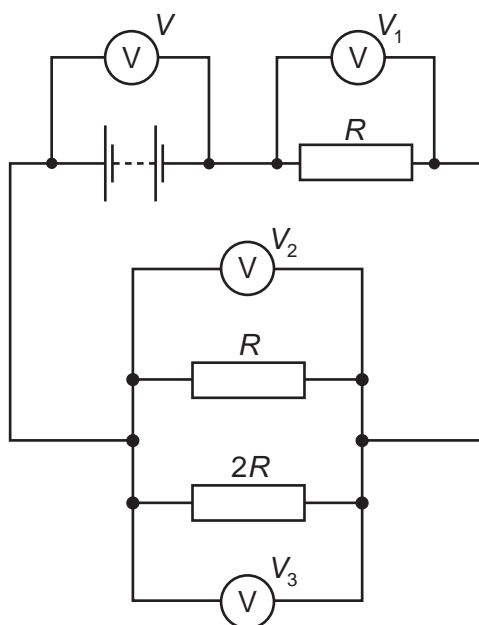

Which equation relating the voltmeter readings must be true?

- A $V = V_1 + V_2 + V_3$
- B $V + V_1 = V_2 + V_3$
- C $V_3 = 2(V_2)$
- D $V - V_1 = V_3$

Space for working

36 A light-dependent resistor (LDR) is connected in series with a resistor R and a battery.

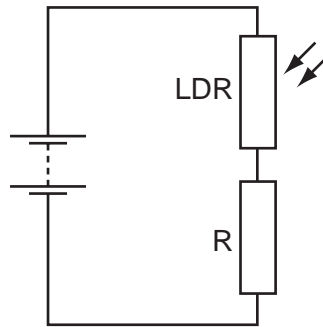

The resistance of the LDR is equal to the resistance of R when no light falls on the LDR.

When the light intensity falling on the LDR increases, which statement is correct?

- A The current in R decreases.
- B The current in the LDR decreases.
- C The p.d. across R decreases.
- D The p.d. across the LDR decreases.

Space for working

- 37 The diagram shows the circuit for a signal to display a green or a red light. It is controlled by the switch S.

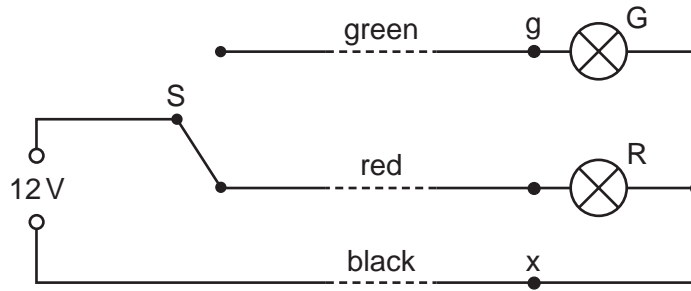

The signal is some way from S to which it is connected by a cable with green, red and black wires. At the signal, the green and red wires are connected to the corresponding lamp and the black wire is connected to a terminal x to provide a common return. The arrangement is shown correctly connected and with the switch set to illuminate the red lamp.

During maintenance, the wires at the signal are disconnected and, when reconnected, the black wire is connected in error to the green lamp (terminal g) instead of terminal x. The red wire is connected correctly to its lamp and connections at S remain as in the diagram.

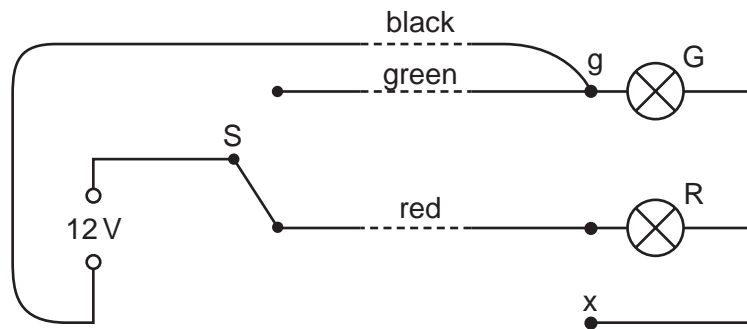

When the system is tested with the switch connection to the red wire, what does the signal show?

- A the green lamp illuminated normally
- B the red lamp illuminated normally
- C the red and green lamps both illuminated normally
- D the red and green lamps both illuminated dimly

Space for working

38 Four identical resistors are connected in the three networks below.

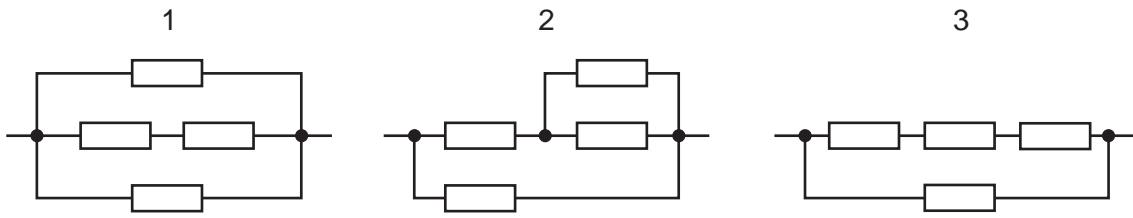

Which arrangement has the highest total resistance and which has the lowest?

	highest	lowest
A	1	2
B	1	3
C	3	1
D	3	2

Space for working

39 Nuclear decay is both spontaneous and random in nature.

Which row gives the correct experimental evidence for these properties?

	spontaneous nature of decay	random nature of decay
A	the decay rate is not affected by pressure	the decay rate is not affected by temperature
B	the decay rate is not affected by pressure	the rate at which radiation is received at a counter fluctuates
C	the decay rate is not affected by temperature	the decay rate is not affected by pressure
D	the rate at which radiation is received at a counter fluctuates	the decay rate is not affected by pressure

40 Radon ${}_{86}^{222}\text{Rn}$ is the start of a decay chain that forms bismuth ${}_{83}^{214}\text{Bi}$ by alpha and beta emission.

For the decay of each nucleus of radon, how many α -particles and β -particles are emitted?

	α -particles	β -particles
A	1	1
B	2	1
C	1	2
D	2	2

Space for working

BLANK PAGE

Permission to reproduce items where third-party owned material protected by copyright is included has been sought and cleared where possible. Every reasonable effort has been made by the publisher (UCLES) to trace copyright holders, but if any items requiring clearance have unwittingly been included, the publisher will be pleased to make amends at the earliest possible opportunity.

University of Cambridge International Examinations is part of the Cambridge Assessment Group. Cambridge Assessment is the brand name of University of Cambridge Local Examinations Syndicate (UCLES), which is itself a department of the University of Cambridge.