



UNIVERSITY OF CAMBRIDGE INTERNATIONAL EXAMINATIONS
General Certificate of Education
Advanced Subsidiary Level and Advanced Level

PHYSICS

9702/12

Paper 1 Multiple Choice

October/November 2011

1 hour

Additional Materials: Multiple Choice Answer Sheet
Soft clean eraser
Soft pencil (type B or HB is recommended)



READ THESE INSTRUCTIONS FIRST

Write in soft pencil.

Do not use staples, paper clips, highlighters, glue or correction fluid.

Write your name, Centre number and candidate number on the Answer Sheet in the spaces provided unless this has been done for you.

There are **forty** questions on this paper. Answer **all** questions. For each question there are four possible answers **A, B, C** and **D**.

Choose the **one** you consider correct and record your choice in **soft pencil** on the separate Answer Sheet.

Read the instructions on the Answer Sheet very carefully.

Each correct answer will score one mark. A mark will not be deducted for a wrong answer.
Any working should be done in this booklet.

This document consists of **24** printed pages.



Data

speed of light in free space,	$c = 3.00 \times 10^8 \text{ m s}^{-1}$
permeability of free space,	$\mu_0 = 4\pi \times 10^{-7} \text{ H m}^{-1}$
permittivity of free space,	$\epsilon_0 = 8.85 \times 10^{-12} \text{ F m}^{-1}$
elementary charge,	$e = 1.60 \times 10^{-19} \text{ C}$
the Planck constant,	$h = 6.63 \times 10^{-34} \text{ J s}$
unified atomic mass constant,	$u = 1.66 \times 10^{-27} \text{ kg}$
rest mass of electron,	$m_e = 9.11 \times 10^{-31} \text{ kg}$
rest mass of proton,	$m_p = 1.67 \times 10^{-27} \text{ kg}$
molar gas constant,	$R = 8.31 \text{ J K}^{-1} \text{ mol}^{-1}$
the Avogadro constant,	$N_A = 6.02 \times 10^{23} \text{ mol}^{-1}$
the Boltzmann constant,	$k = 1.38 \times 10^{-23} \text{ J K}^{-1}$
gravitational constant,	$G = 6.67 \times 10^{-11} \text{ N m}^2 \text{ kg}^{-2}$
acceleration of free fall,	$g = 9.81 \text{ m s}^{-2}$

Formulae

uniformly accelerated motion,

$$s = ut + \frac{1}{2}at^2$$

$$v^2 = u^2 + 2as$$

work done on/by a gas,

$$W = p\Delta V$$

gravitational potential,

$$\phi = -\frac{Gm}{r}$$

hydrostatic pressure,

$$p = \rho gh$$

pressure of an ideal gas,

$$p = \frac{1}{3} \frac{Nm}{V} \langle c^2 \rangle$$

simple harmonic motion,

$$a = -\omega^2 x$$

velocity of particle in s.h.m.,

$$v = v_0 \cos \omega t$$

$$v = \pm \omega \sqrt{x_0^2 - x^2}$$

electric potential,

$$V = \frac{Q}{4\pi\epsilon_0 r}$$

capacitors in series,

$$1/C = 1/C_1 + 1/C_2 + \dots$$

capacitors in parallel,

$$C = C_1 + C_2 + \dots$$

energy of charged capacitor,

$$W = \frac{1}{2}QV$$

resistors in series,

$$R = R_1 + R_2 + \dots$$

resistors in parallel,

$$1/R = 1/R_1 + 1/R_2 + \dots$$

alternating current/voltage,

$$x = x_0 \sin \omega t$$

radioactive decay,

$$x = x_0 \exp(-\lambda t)$$

decay constant,

$$\lambda = \frac{0.693}{t_{\frac{1}{2}}}$$

1 Which quantity can be measured in electronvolts (eV)?

- A electric charge
- B electric potential
- C energy
- D power

2 What is the ratio $\frac{10^{-3} \text{ THz}}{10^3 \text{ kHz}}$?

- A 10^{-9} B 10^{-6} C 10^0 D 10^3

3 The following physical quantities can be either positive or negative.

s : displacement of a particle along a straight line

θ : temperature on the Celsius scale

q : electric charge

V : readings on a digital voltmeter

Which of these quantities are vectors?

- A s, θ, q, V B s, q, V only C θ, V only D s only

Space for working

- 4 A micrometer is used to measure the diameters of two cylinders.

diameter of first cylinder = 12.78 ± 0.02 mm

diameter of second cylinder = 16.24 ± 0.03 mm

The difference in the diameters is calculated.

What is the uncertainty in this difference?

- A** ± 0.01 mm **B** ± 0.02 mm **C** ± 0.03 mm **D** ± 0.05 mm
- 5 The speedometer in a car consists of a pointer which rotates. The pointer is situated several millimetres from a calibrated scale.
- What could cause a random error in the driver's measurement of the car's speed?
- A** The car's speed is affected by the wind direction.
- B** The driver's eye is not always in the same position in relation to the pointer.
- C** The speedometer does not read zero when the car is at rest.
- D** The speedometer reads 10% higher than the car's actual speed.

Space for working

6 The velocity of an object during the first five seconds of its motion is shown on the graph.

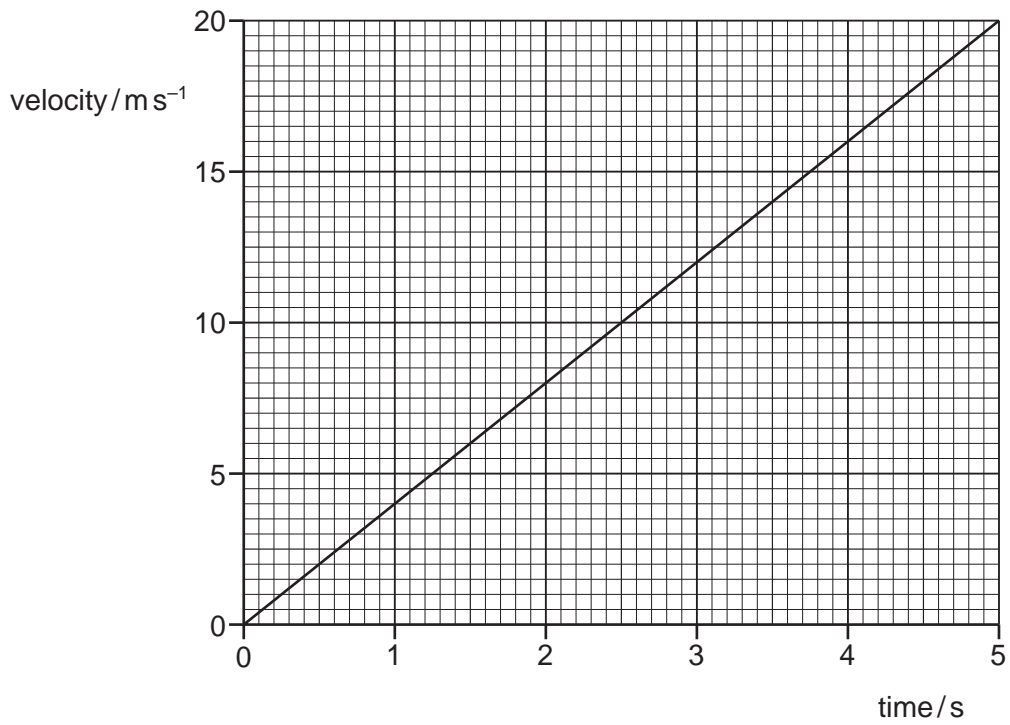

What is the distance travelled by the object in this time?

- A** 4 m **B** 20 m **C** 50 m **D** 100 m

Space for working

- 7 A stone of mass m is dropped from a tall building. There is significant air resistance. The acceleration of free fall is g .

When the stone reaches its terminal velocity, which information is correct?

	magnitude of the acceleration of the stone	magnitude of the force of gravity on the stone	magnitude of the force of air resistance on the stone
A	g	mg	mg
B	zero	mg	mg
C	zero	zero	mg
D	zero	zero	zero

- 8 The variation with time t of the distance s moved by a body is shown below.

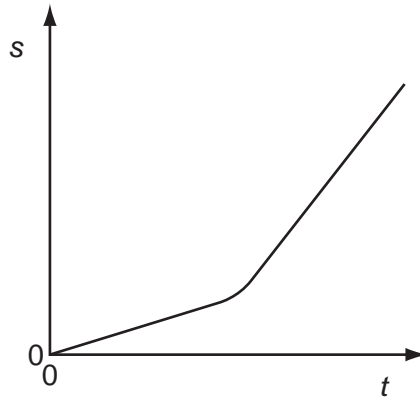

What can be deduced from the graph about the motion of the body?

- A** It accelerates continuously.
- B** It starts from rest.
- C** The distance is proportional to time.
- D** The speed changes.

Space for working

- 9 A golf ball is hit by a club. The graph shows the variation with time of the force exerted on the ball by the club.

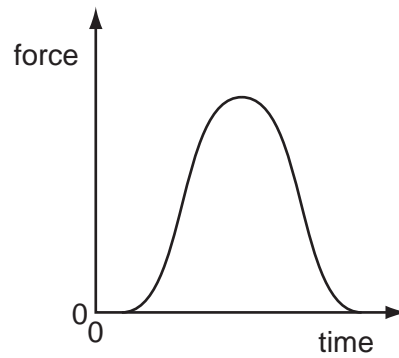

Which quantity, for the time of contact, **cannot** be found from the graph?

- A the average force on the ball
- B the change in momentum of the ball
- C the contact time between the ball and the club
- D the maximum acceleration of the ball

Space for working

- 10 A group of students investigating the principle of conservation of momentum use a small truck travelling over a frictionless surface.

Sand is dropped into the truck as it passes X. At Y, a trapdoor in the bottom of the truck opens and the sand falls out.



How does the velocity of the truck change when the sand is added to the truck at X and then leaves the truck at Y?

	at X	at Y
A	decreases	increases
B	decreases	stays the same
C	stays the same	increases
D	stays the same	stays the same

- 11 An object of mass 20 kg is travelling at a constant speed of 6.0 m s^{-1} .

It collides with an object of mass 12 kg travelling at a constant speed of 15 m s^{-1} in the opposite direction. The objects stick together.

What is the speed of the objects immediately after the collision?

- A** 1.9 m s^{-1} **B** 9.0 m s^{-1} **C** 9.4 m s^{-1} **D** 21 m s^{-1}

Space for working

- 12 Two possible displacements of an object are represented by the vectors P and Q.

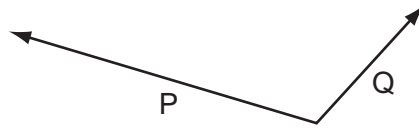

Which vector best represents the resultant displacement ($P - Q$) of the object?

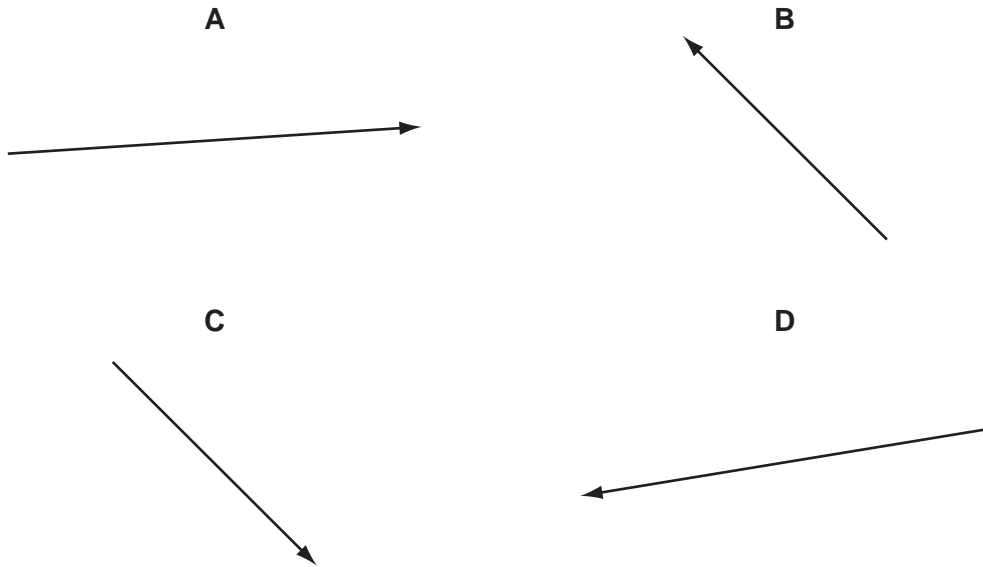

- 13 Two co-planar forces act on the rim of a wheel. The forces are equal in magnitude.

Which arrangement of forces provides only a couple?

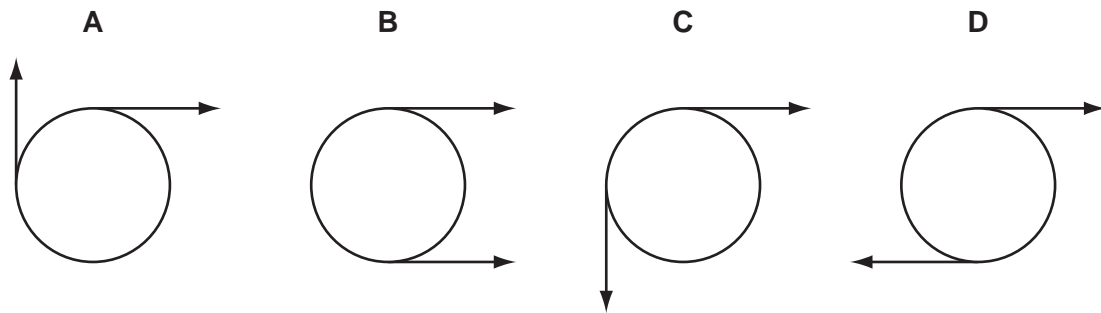

Space for working

- 14 A trailer of weight 30 kN is hitched to a cab at X, as shown in the diagram.

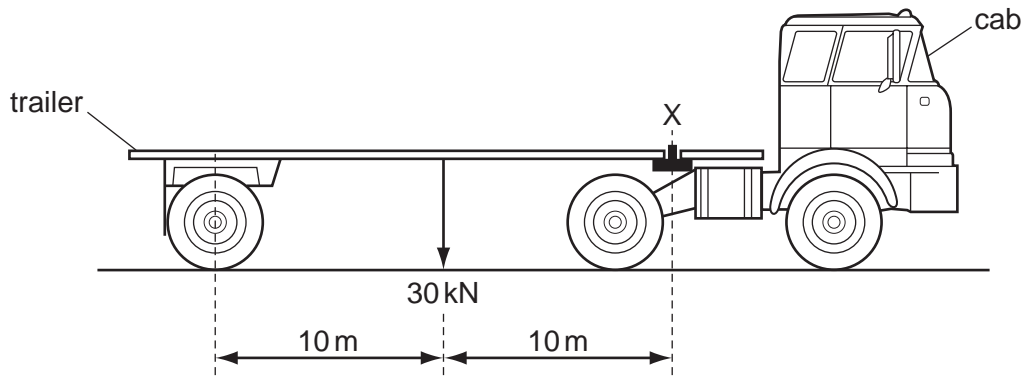

What is the upward force exerted by the cab on the trailer at X?

- A 3 kN B 15 kN C 30 kN D 60 kN
- 15 When a horizontal force F is applied to a frictionless trolley over a distance s , the kinetic energy of the trolley changes from 4 J to 8 J.
- If a force of $2F$ is applied to the trolley over a distance of $2s$, what will the original kinetic energy of 4 J become?
- A 16 J B 20 J C 32 J D 64 J
- 16 The kinetic energy of a vehicle of mass 1000 kg is 4.5×10^5 J. It is braked with a total constant braking force of 6000 N.
- What will be its stopping distance?
- A 37 m B 75 m C 150 m D 300 m

Space for working

- 17 In many old-style filament lamps, as much as 92 J of energy is emitted as thermal energy for every 8 J of energy emitted as light.

What is the efficiency of the lamp, as the percentage of electrical energy converted to light energy?

- A 8% B 9% C 91% D 92%

- 18 What is the unit of power in SI base units?

- A kg ms^{-2} B kg ms^{-3} C $\text{kg m}^2 \text{s}^{-2}$ D $\text{kg m}^2 \text{s}^{-3}$

- 19 In an experiment to demonstrate Brownian motion, smoke particles in a container are illuminated by a strong light source and observed through a microscope.

The particles are seen as small specks of light that are in motion.

What causes the Brownian motion?

- A collisions between the smoke particles and air molecules
B collisions between the smoke particles and the walls of the container
C convection currents within the air as it is warmed by the light source
D kinetic energy gained by the smoke particles on absorption of light

Space for working

- 20 A horizontal plate of area 0.036 m^2 is beneath the surface of a liquid of density 930 kg m^{-3} . The force on the plate due to the pressure of the liquid is 290 N .

What is the depth of the plate beneath the surface of the liquid?

- A 0.88 m B 1.13 m C 8.7 m D 9.1 m

- 21 The graph shows the relationship between stress and strain for three wires of the same linear dimensions but made from different materials.

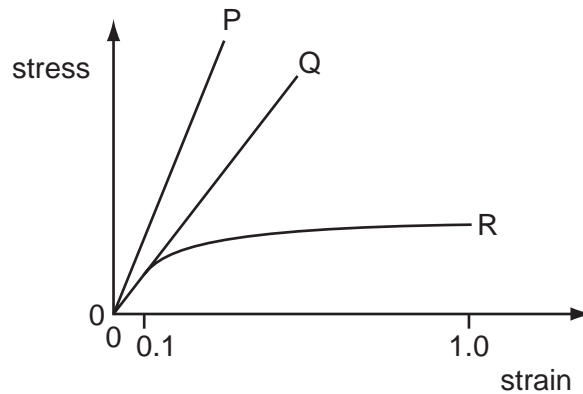

Which statements are correct?

- 1 The extension of P is approximately twice that of Q for the same stress.
- 2 The ratio of the Young modulus for P to that of Q is approximately two.
- 3 For strain less than 0.1, R obeys Hooke's law.

- A 1, 2 and 3 B 1 and 3 only C 2 and 3 only D 2 only

Space for working

22 The graph shows the effect of applying a force of up to 5 N to a spring.

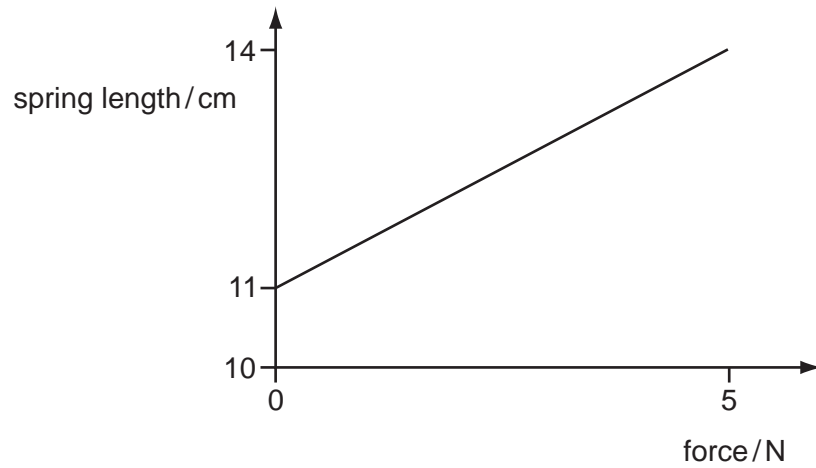

What is the total increase in length produced by a 7 N force, assuming the spring obeys Hooke's law?

- A** 4.2 cm **B** 5.6 cm **C** 15.2 cm **D** 19.6 cm

Space for working

23 The following force-extension graphs are drawn to the same scale.

Which graph represents the deformed object with the greatest amount of elastic potential energy?

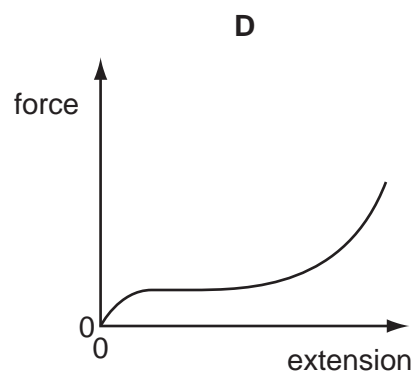
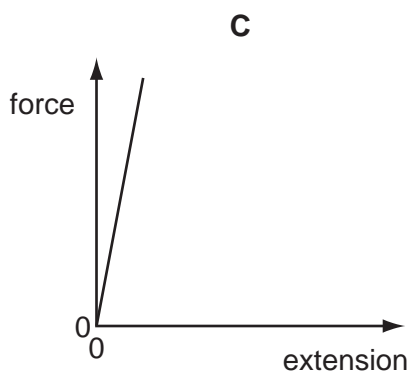
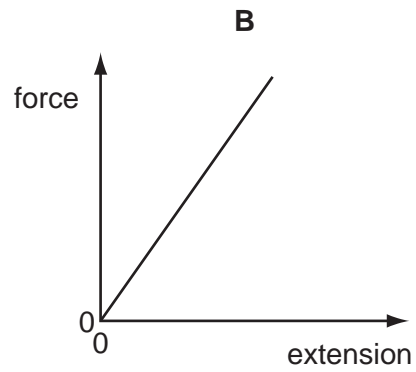
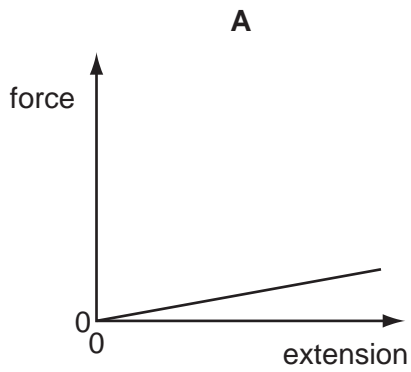

Space for working

- 24 A wave that can be polarised must be
- A longitudinal.
 - B progressive.
 - C stationary.
 - D transverse.
- 25 Which statement about electromagnetic radiation is correct?
- A Waves of wavelength 5×10^{-9} m are high-energy gamma rays.
 - B Waves of wavelength 3×10^{-8} m are ultra-violet waves.
 - C Waves of wavelength 5×10^{-7} m are infra-red waves.
 - D Waves of wavelength 9×10^{-7} m are light waves.

Space for working

26 The diagram shows two sinusoidal waveforms.

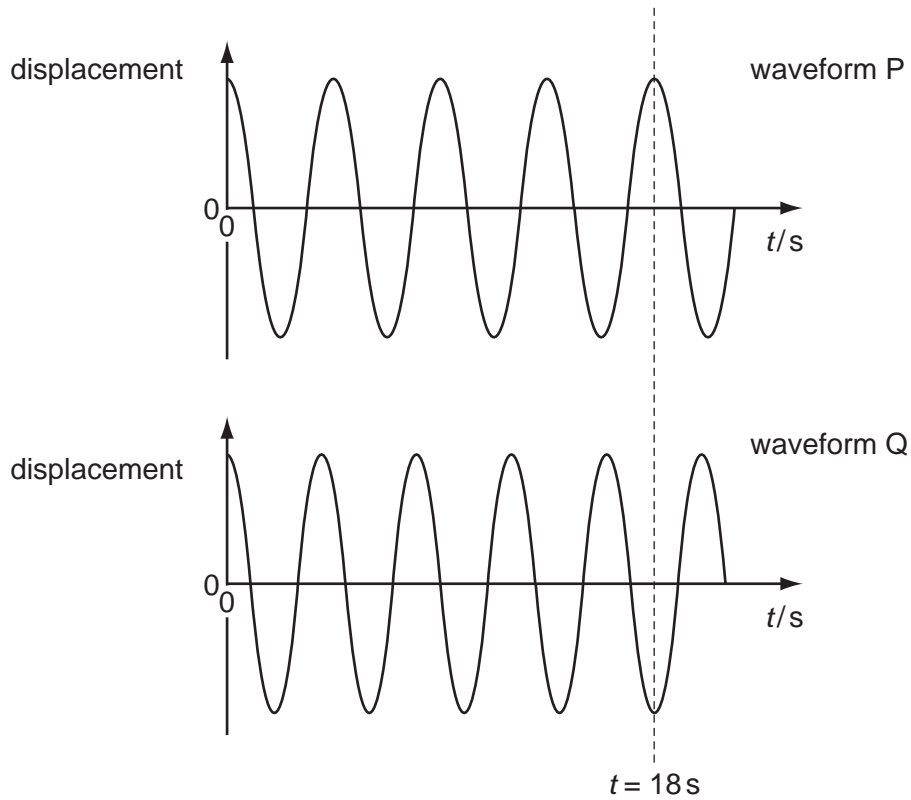

At time $t = 0$ the waves are in phase. At the dotted line, $t = 18$ s.

At which time is the phase difference between the two oscillations $\frac{1}{8}$ of a cycle?

- A** 4.0 s **B** 4.5 s **C** 8.0 s **D** 9.0 s

Space for working

- 27 A sound wave is set up in a long tube, closed at one end. The length of the tube is adjusted until the sound from the tube is loudest.

What is the nature of the sound wave in the tube?

- A longitudinal and progressive
 - B longitudinal and stationary
 - C transverse and progressive
 - D transverse and stationary
- 28 Two light sources produce visible interference fringes only in certain circumstances.

Which condition enables visible interference fringes to be formed?

- A using a white light source
- B using incoherent sources
- C using one light source which is polarised at right angles to light from the other source
- D using sources from which the light does not overlap

Space for working

- 29 The diagram shows a pair of parallel metal plates 4.0 mm apart connected to a 9.0 V battery.

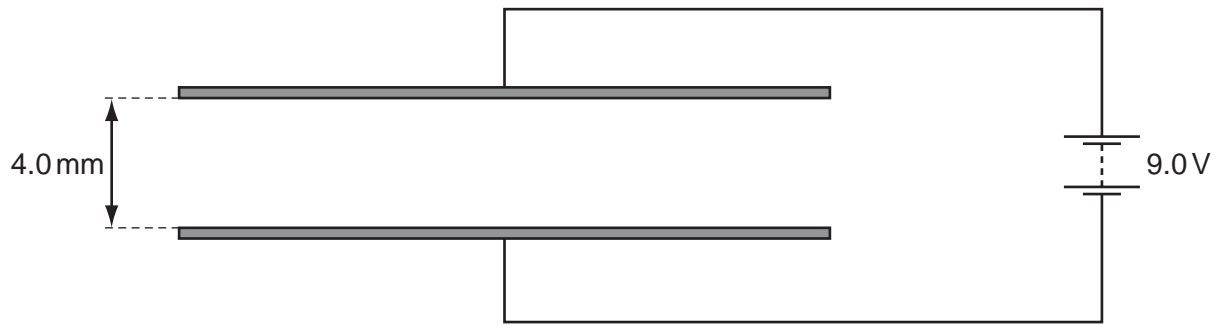

What is the electric field strength between the plates?

- A $4.4 \times 10^{-4} \text{ NC}^{-1}$
 B $3.6 \times 10^{-2} \text{ NC}^{-1}$
 C 36 NC^{-1}
 D $2.3 \times 10^3 \text{ NC}^{-1}$
- 30 Which path shows a possible movement of an electron in the electric field shown?

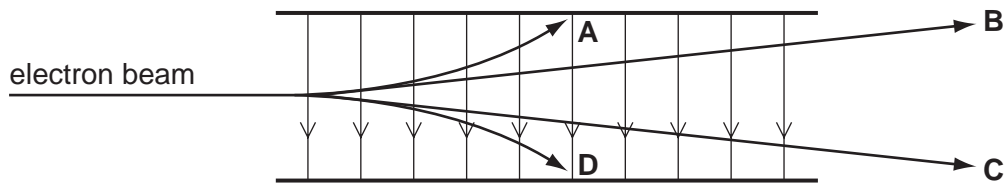

Space for working

31 The diagram shows a non-uniform electric field near a positively charged and a negatively charged sphere.

Four electrons, **A**, **B**, **C** and **D**, are shown at different positions in the field.

On which electron is the direction of the force on the electron shown correctly?

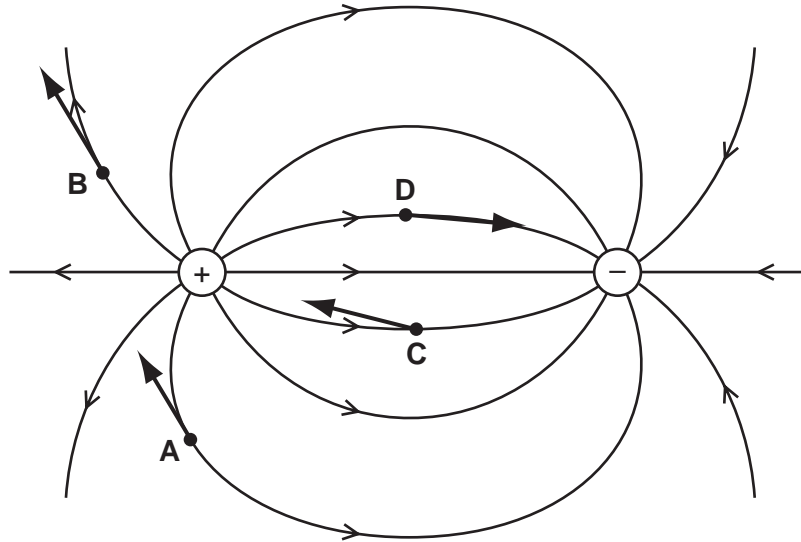

32 A charge of 8.0 C passes through a resistor of resistance $30\ \Omega$ at a constant rate in a time of 20 s .

What is the potential difference across the resistor?

- A** 0.40 V **B** 5.3 V **C** 12 V **D** 75 V

Space for working

- 33 The graph shows the variation with potential difference (p.d.) of the current in a lamp filament.

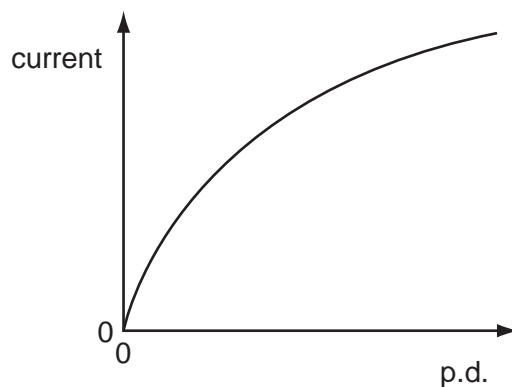

Which statement explains the shape of this graph?

- A** As the filament temperature rises, electrons can pass more easily through the filament.
B It takes time for the filament to reach its working temperature.
C The power output of the filament is proportional to the square of the current in it.
D The resistance of the filament increases with a rise in temperature.
- 34 Two electrically-conducting cylinders X and Y are made from the same material.

Their dimensions are as shown.

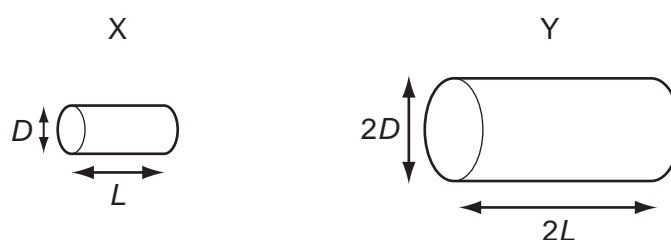

The resistance of each cylinder is measured between its ends.

What is the ratio $\frac{\text{resistance of X}}{\text{resistance of Y}}$?

- A** $\frac{2}{1}$ **B** $\frac{1}{1}$ **C** $\frac{1}{2}$ **D** $\frac{1}{4}$

Space for working

- 35 A power supply of electromotive force (e.m.f.) 12 V and internal resistance $2\ \Omega$ is connected in series with a load resistor. The value of the load resistor is varied from $0.5\ \Omega$ to $4\ \Omega$.

Which graph shows how the power P dissipated in the load resistor varies with the resistance of the load resistor?

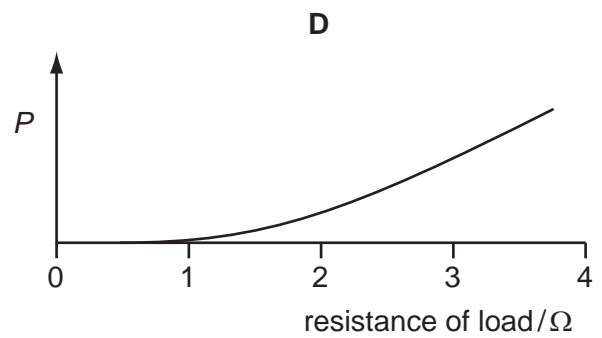
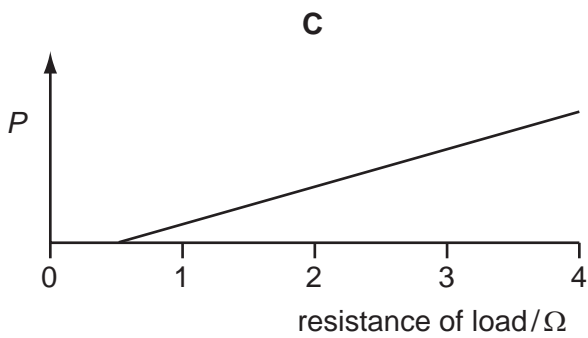
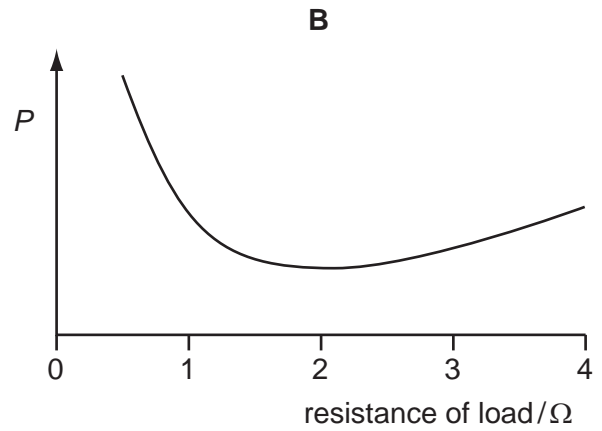

Space for working

36 Each of Kirchhoff's laws is linked to the conservation of a physical quantity.

Which physical quantities are assumed to be conserved in the formulation of Kirchhoff's first law and of Kirchhoff's second law?

	Kirchhoff's first law	Kirchhoff's second law
A	energy	charge
B	energy	momentum
C	charge	energy
D	momentum	energy

37 The diagram shows a potential divider circuit which, by adjustment of the contact X, can be used to provide a variable potential difference between the terminals P and Q.

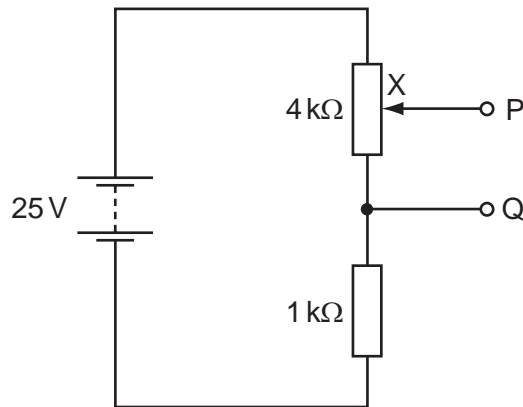

What are the limits of this potential difference?

- A** 0 and 5V **B** 0 and 20V **C** 0 and 25V **D** 5V and 25V

Space for working

- 38 A constant 60 V d.c. supply is connected across two resistors of resistance 400 k Ω and 200 k Ω .

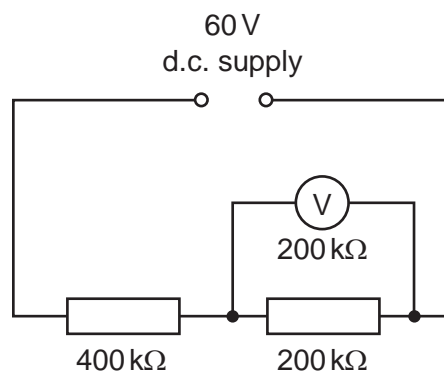

What is the reading on a voltmeter, also of resistance 200 k Ω , when connected across the 200 k Ω resistor as shown in the diagram?

- A** 12 V **B** 15 V **C** 20 V **D** 30 V
- 39 Which statement concerning α -particles is correct?
- A** An α -particle has charge $+4e$.
- B** An α -particle is a helium atom.
- C** When α -particles travel through air, they cause ionisation.
- D** When α -particles travel through a sheet of gold foil, they make the gold radioactive.
- 40 A nucleus of the nuclide ${}^{241}_{94}\text{Pu}$ decays by emission of a β -particle followed by the emission of an α -particle.

Which nucleus is formed?

- A** ${}^{239}_{93}\text{Np}$ **B** ${}^{239}_{91}\text{Pa}$ **C** ${}^{237}_{93}\text{Np}$ **D** ${}^{237}_{92}\text{U}$

Space for working

Permission to reproduce items where third-party owned material protected by copyright is included has been sought and cleared where possible. Every reasonable effort has been made by the publisher (UCLES) to trace copyright holders, but if any items requiring clearance have unwittingly been included, the publisher will be pleased to make amends at the earliest possible opportunity.

University of Cambridge International Examinations is part of the Cambridge Assessment Group. Cambridge Assessment is the brand name of University of Cambridge Local Examinations Syndicate (UCLES), which is itself a department of the University of Cambridge.