



UNIVERSITY OF CAMBRIDGE INTERNATIONAL EXAMINATIONS  
 General Certificate of Education  
 Advanced Subsidiary Level and Advanced Level

CANDIDATE  
NAME

CENTRE  
NUMBER

|  |  |  |  |  |
|--|--|--|--|--|
|  |  |  |  |  |
|--|--|--|--|--|

CANDIDATE  
NUMBER

|  |  |  |  |
|--|--|--|--|
|  |  |  |  |
|--|--|--|--|



**CHEMISTRY**

**9701/43**

Paper 4 Structured Questions

**October/November 2012**

**2 hours**

Candidates answer on the Question Paper.

Additional Materials: Data Booklet

**READ THESE INSTRUCTIONS FIRST**

Write your Centre number, candidate number and name on all the work you hand in.

Write in dark blue or black pen.

You may use a soft pencil for any diagrams, graphs or rough working.

Do not use staples, paper clips, highlighters, glue or correction fluid.

**DO NOT WRITE IN ANY BARCODES.**

**Section A**

Answer **all** questions.

**Section B**

Answer **all** questions.

You may lose marks if you do not show your working or if you do not use appropriate units.

A Data Booklet is provided.

At the end of the examination, fasten all your work securely together.

The number of marks is given in brackets [ ] at the end of each question or part question.

| For Examiner's Use |  |
|--------------------|--|
| 1                  |  |
| 2                  |  |
| 3                  |  |
| 4                  |  |
| 5                  |  |
| 6                  |  |
| 7                  |  |
| 8                  |  |
| <b>Total</b>       |  |

bestexamhelp.com

This document consists of **17** printed pages and **3** blank pages.



## Section A

Answer **all** the questions in the spaces provided.

- 1 (a) Write down what you would see, and write equations for the reactions that occur, when magnesium chloride, aluminium chloride and silicon tetrachloride are separately mixed with water.

magnesium chloride

.....  
 .....

aluminium chloride

.....  
 .....

silicon tetrachloride

.....  
 .....

[5]

- (b) Sodium chloride is traditionally added to a particular meat product. In response to the evidence that sodium chloride can lead to high blood pressure, the manufacturers have replaced the sodium chloride with a mixture of sodium and potassium chlorides. 100 g of the meat product usually contains about 2 g of the chloride mixture. A particular meat product contains 1.10 g of sodium chloride and 0.90 g potassium chloride in 100 g.

- (i) Calculate the number of moles of chloride ions in 100 g of this meat product.

The amount of chloride in the meat product can be found by titration with silver nitrate solution.

- (ii) Write the ionic equation, including state symbols, for the reaction between aqueous sodium chloride and aqueous silver nitrate.

.....

The chlorides from 100 g meat product are extracted into water and the solution made up to 1000 cm<sup>3</sup> in a volumetric flask. A 10.0 cm<sup>3</sup> portion of this solution is then titrated with 0.0200 mol dm<sup>-3</sup> silver nitrate solution to precipitate the chloride.

- (iii) Calculate the volume of 0.0200 mol dm<sup>-3</sup> silver nitrate solution that would be required if this titration were carried out on 100 g of the particular meat product described above.

[5]

- (c) The iodination of benzene requires the presence of nitric acid.

- (i) Using bond enthalpies from the *Data Booklet*, calculate the enthalpy change for the following reaction.

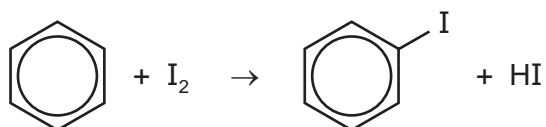

- (ii) Nitric acid reacts with hydrogen iodide according to the following unbalanced equation.

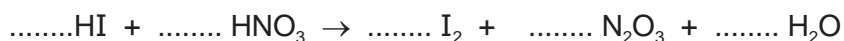

Balance this equation, and describe how the oxidation numbers of nitrogen and iodine have changed during the reaction.

nitrogen .....

iodine .....

[4]

[Total: 14]

2 Nitrogen oxides in the atmosphere are homogeneous catalysts in the formation of acid rain.

(a) What is meant by the following terms?

*catalyst*

.....  
.....

*homogeneous*

.....  
.....

[2]

(b) (i) State a major source of nitrogen oxides in the atmosphere, explaining how they are formed.

.....  
.....  
.....

(ii) Use equations to describe the chemical role played by nitrogen oxides in the formation of acid rain.

.....  
.....  
.....  
.....

[5]

- (c) Use the following axes to draw a fully labelled reaction pathway diagram showing the effect of a catalyst on an exothermic reaction. Label the  $\Delta H$  and  $E_a$  values.

*For  
Examiner's  
Use*

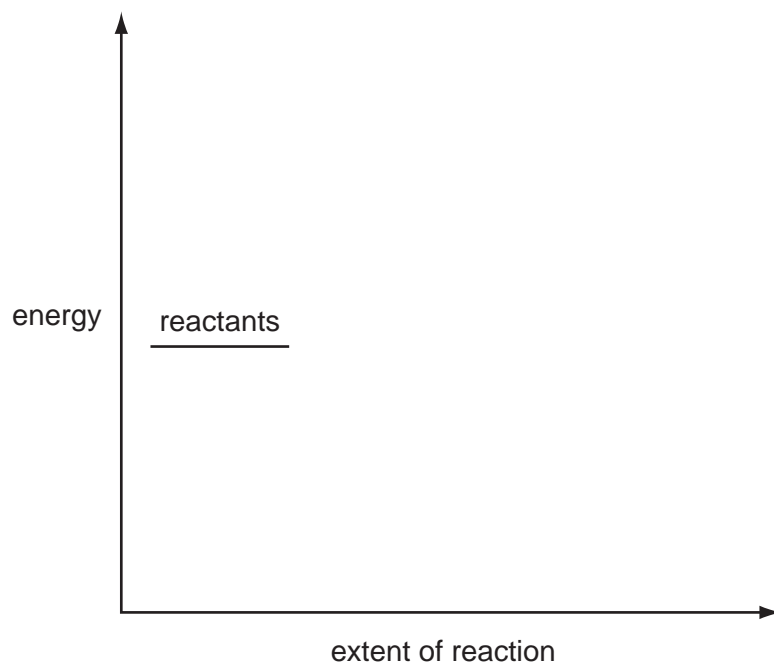

[3]

[Total: 10]

- 3 (a) Complete the following electronic configuration of the  $\text{Cu}^{2+}$  ion.

$1s^2 2s^2 2p^6$  ..... [1]

- (b) In a free, gas-phase transition metal ion, the d-orbitals all have the same energy, but when the ion is in a complex the orbitals are split into two energy levels.

- (i) Explain why this happens.

.....  
.....

- (ii) How does this splitting help to explain why transition metal complexes are often coloured?

.....  
.....  
.....  
.....

- (iii) Why does the colour of a transition metal complex depend on the nature of the ligands surrounding the transition metal ion?

.....  
.....

[5]

- (c) Draw a fully-labelled diagram of the apparatus you could use to measure the  $E^\ominus$  of a cell composed of the  $\text{Fe}^{3+}/\text{Fe}^{2+}$  electrode and the  $\text{Cu}^{2+}/\text{Cu}$  electrode.

[5]

(d) The  $E^\ominus$  for  $\text{Cu}^{2+}/\text{Cu}$  is +0.34 V. When  $\text{NH}_3(\text{aq})$  is added to the electrode solution, the  $E_{\text{electrode}}$  changes.

(i) Describe the type of reaction taking place between  $\text{Cu}^{2+}(\text{aq})$  and  $\text{NH}_3(\text{aq})$ .

.....

(ii) Write an equation for the reaction.

.....

(iii) Describe the change in the colour of the solution.

.....

(iv) Predict and explain how the  $E_{\text{electrode}}$  might change on the addition of  $\text{NH}_3(\text{aq})$ .

.....

.....

[4]

(e) Fehling's reagent is an alkaline solution of  $\text{Cu}^{2+}$  ions complexed with tartrate ions. It is used in organic chemistry to test for a particular functional group.

(i) **Name** the functional group involved.

.....

(ii) Describe the appearance of a positive result in this test.

.....

(iii) Write an equation for the reaction between  $\text{Cu}^{2+}$  and  $\text{OH}^-$  ions and a two-carbon compound containing the functional group you named in (i).

.....

[3]

(f) A solution containing a mixture of tartaric acid and its sodium salt is used as a buffer in some pre-prepared food dishes.

Calculate the pH of a solution containing  $0.50 \text{ mol dm}^{-3}$  of tartaric acid and  $0.80 \text{ mol dm}^{-3}$  sodium tartrate.

$[K_a(\text{tartaric acid}) = 9.3 \times 10^{-4} \text{ mol dm}^{-3}]$

pH = .....

[2]

[Total: 20]

- 4 The compound responsible for the yellow colour of the spice turmeric is curcumin. Its molecular structure can be deduced from the following series of reactions. The  $\text{CH}_3\text{O}$ – group that is present in curcumin may be regarded as unreactive.

For  
Examiner's  
Use

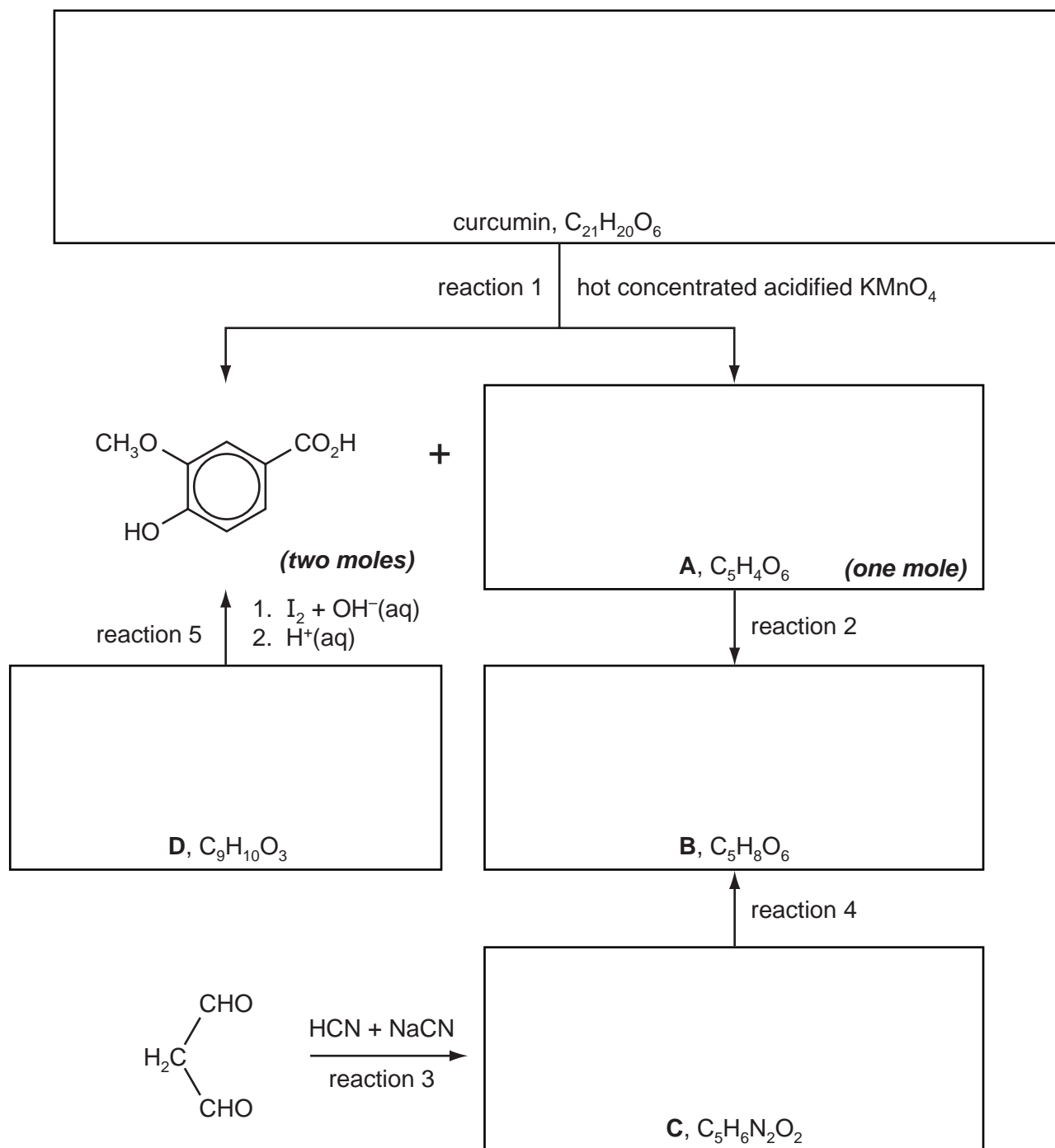

Curcumin and compounds **A** and **D** all react with 2,4-dinitrophenylhydrazine reagent.

Compounds **A** and **B** effervesce with  $\text{Na}_2\text{CO}_3(\text{aq})$ , but curcumin, and compounds **C** and **D**, do not.

Curcumin reacts with  $\text{Br}_2(\text{aq})$  and with cold dilute acidified  $\text{KMnO}_4$



- (a) (i) Name the functional group common to curcumin and compounds **A** and **D**.

.....

- (ii) Name the functional group common to compounds **A** and **B**.

.....

[2]

- (b) (i) Suggest the structures of compounds **B**, **C** and **D**, and draw their structural formulae in the relevant boxes opposite.

- (ii) Suggest suitable reagents and conditions for reaction 4.

.....

[4]

- (c) (i) Name the *type of reaction* for reaction 2.

.....

- (ii) Suggest a reagent for reaction 2.

.....

- (iii) Suggest the structure of compound **A**, and draw its structural formula in the relevant box opposite.

[3]

- (d) (i) **Name** the functional group in curcumin that reacts with cold dilute acidified  $\text{KMnO}_4$ .

.....

- (ii) **Name two** functional groups in curcumin that react with  $\text{Br}_2(\text{aq})$ .

.....

[2]

- (e) Suggest a structure for curcumin and draw its structural formula in the relevant box opposite.

[2]

[Total: 13]

5 (a) (i) Explain why ethylamine is basic.

.....  
 .....

(ii) Write an equation showing ethylamine acting as

a base, .....

a nucleophile. ....

(iii) Why is phenylamine less basic than ethylamine?

.....  
 .....

Alkaloids are naturally-occurring compounds that act as bases.

(iv) Suggest the structure of the product, **E**, of the reaction between the alkaloid nicotine and an excess of  $\text{HCl}(\text{aq})$ .

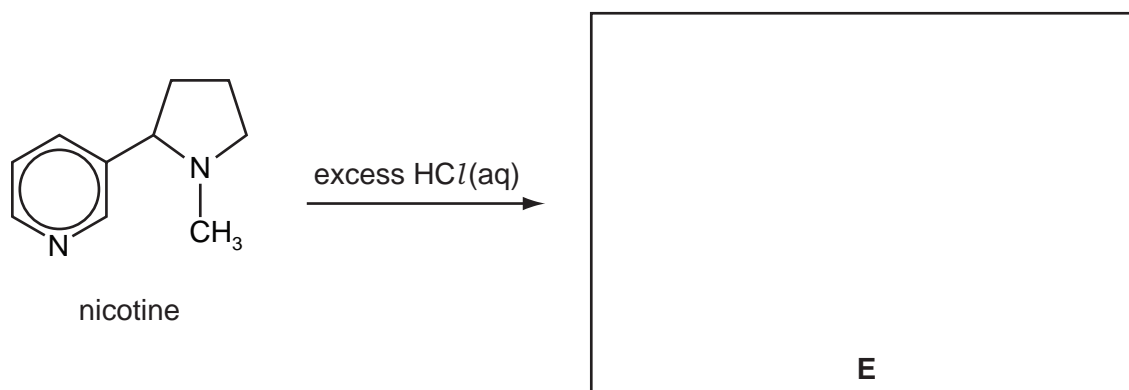

[6]

(b) Phenylamine, and substituted phenylamines, are used to make cloth dyes and food colourants.

The first step in this process is the production of a diazonium salt.

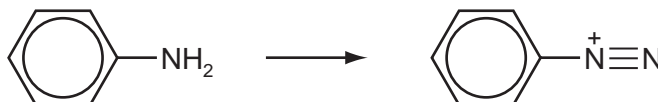

(i) State the reagents and conditions necessary for this reaction.

.....

The diazonium salt is then reacted with a phenol or an aryl amine in alkaline solution.

For  
Examiner's  
Use

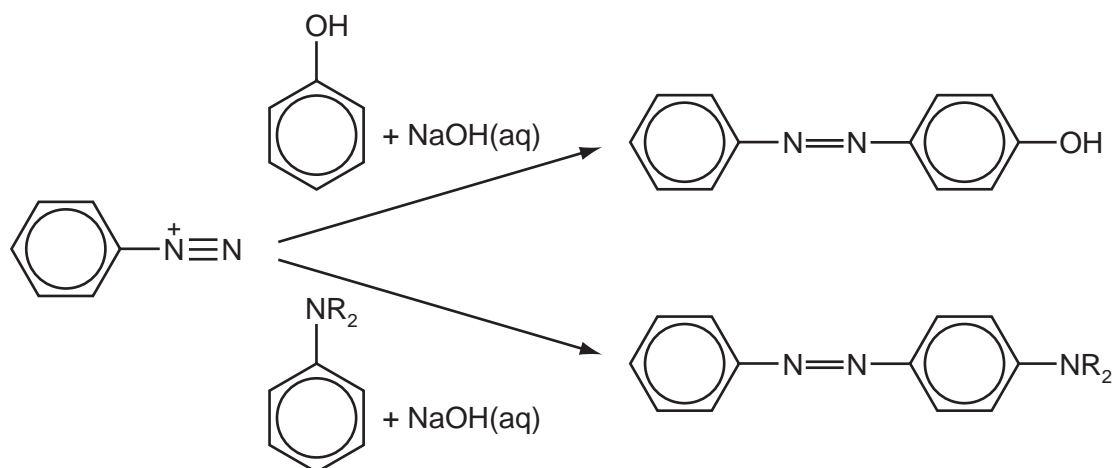

- (ii) Suggest the starting materials needed to synthesise the following dyes. Draw their structures in the boxes provided.

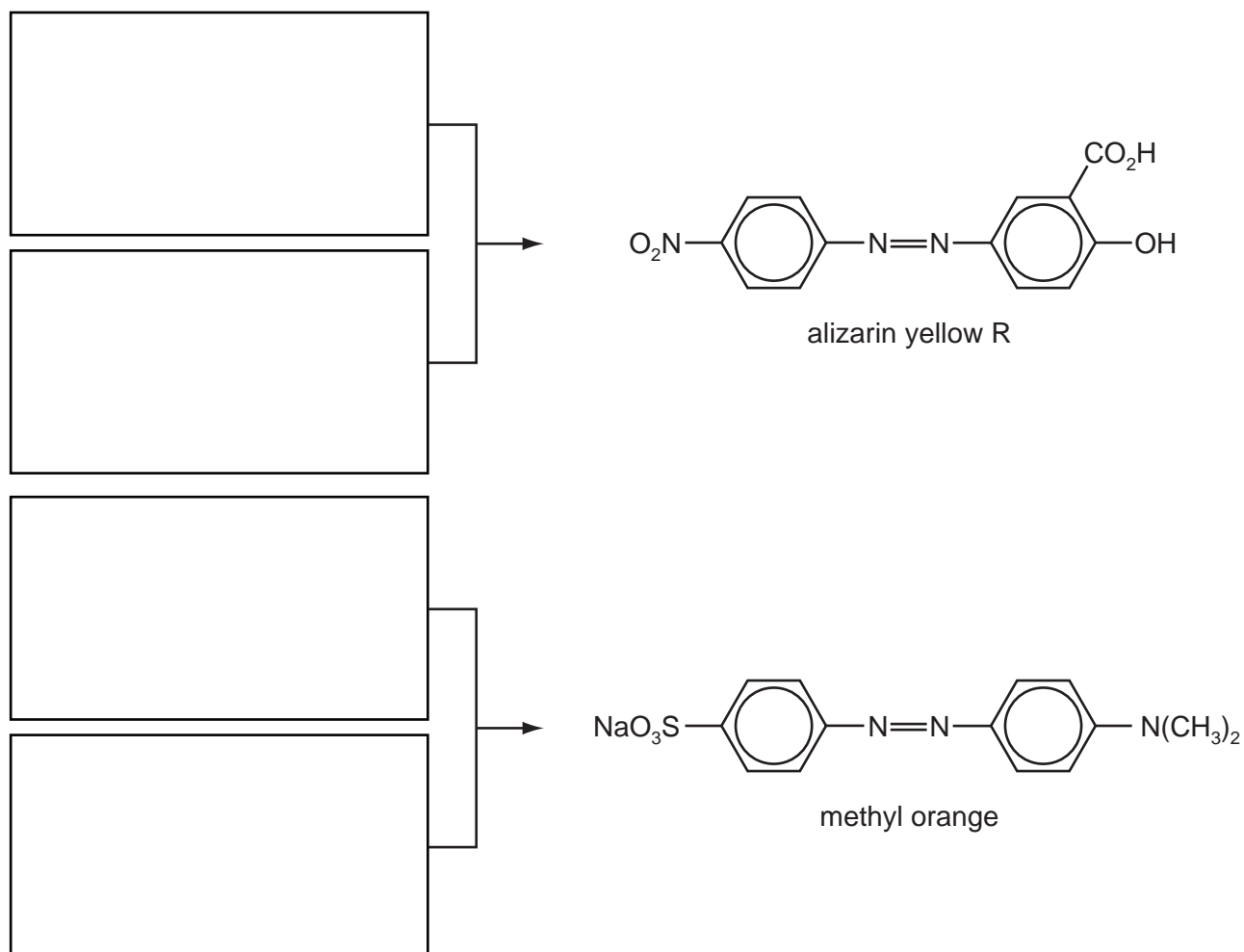

- (iii) Suggest what effect the  $\text{NaO}_3\text{S}$ – group in methyl orange has on its properties. This group has no effect on the colour of the compound.

[7]

[Total: 13]

## Section B

Answer **all** the questions in the spaces provided.

- 6 The proteins in the human body are complex polymers made up of around 20 different amino acids. Alanine is a typical amino acid.

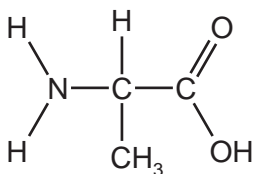

alanine

- (a) Glycine,  $\text{H}_2\text{NCH}_2\text{CO}_2\text{H}$ , is the simplest amino acid and differs from each of the other 2-amino acids in a significant way. What is this difference?

..... [1]

- (b) Protein molecules coil and fold, producing molecules with complex three-dimensional shapes. This is referred to as the secondary and tertiary structures of a protein.

- (i) State **one** form of **secondary** structure and give the type of bonding responsible.

structure .....

bonding .....

- (ii) Give **two** examples of bonding causing the **tertiary** structure, and give the amino acid responsible in each case.

bonding ..... amino acid .....

bonding ..... amino acid .....

[6]

- (c) Suggest why globular proteins, such as enzymes, contain relatively small amounts of glycine and alanine when compared to the amounts of some other amino acids. You may wish to refer to their structures given above.

.....

..... [1]

(d) DNA consists of a double helix with each strand having a sugar-phosphate 'backbone' with one of four bases – adenine (A), cytosine (C), guanine (G) and thymine (T) – attached to the sugar.

(i) The two strands of the double helix are held together by hydrogen bonds between pairs of bases. What are the pairs of bases?

.....  
 .....

In protein synthesis, sections of the DNA are copied by mRNA and this, in turn, is read by the ribosome in order to assemble the amino acids for the new protein chain. Each group of three bases codes for one amino acid, with some amino acids having several codes. The codes are summarised below.

|     |               |     |     |     |      |     |      |
|-----|---------------|-----|-----|-----|------|-----|------|
| UUU | phe           | UCU | ser | UAU | tyr  | UGU | cys  |
| UUC | phe           | UCC | ser | UAC | tyr  | UGC | cys  |
| UUA | leu           | UCA | ser | UAA | stop | UGA | stop |
| UUG | leu           | UCG | ser | UAG | stop | UGG | trp  |
| CUU | leu           | CCU | pro | CAU | his  | CGU | arg  |
| CUC | leu           | CCC | pro | CAC | his  | CGC | arg  |
| CUA | leu           | CCA | pro | CAA | gln  | CGA | arg  |
| CUG | leu           | CCG | pro | CAG | gln  | CGG | arg  |
| AUU | ile           | ACU | thr | AAU | asn  | AGU | ser  |
| AUC | ile           | ACC | thr | AAC | asn  | AGC | ser  |
| AUA | ile           | ACA | thr | AAA | lys  | AGA | arg  |
| AUG | met/<br>start | ACG | thr | AAG | lys  | AGG | arg  |
| GUU | val           | GCU | ala | GAU | asp  | GGU | gly  |
| GUC | val           | GCC | ala | GAC | asp  | GGC | gly  |
| GUA | val           | GCA | ala | GAA | glu  | GGA | gly  |
| GUG | val           | GCG | ala | GAG | glu  | GGG | gly  |

(ii) The coding for all protein chains starts with the AUG, and ends with one of three 'stop' codes shown in the table. What amino acid sequence would the following series of bases produce?

-AUGGGUAGCCUCGCAUCGUAA-

.....

(iii) What would be the effect on the amino acid sequence, of a mutation that changed the base at position 10 in the series of bases above from C to G?

.....

[5]

[Total: 13]

- 7 Although the chemical reactions of compounds remain important pointers to their functional groups, instrumental techniques such as mass spectrometry and NMR spectroscopy are increasingly used to determine molecular structures.

(a) Compound **J** was analysed using these two techniques with the following results.

The mass spectrum showed that

- the M peak was at  $m/e$  86,
- the ratio of heights of the M and M+1 peaks was 23.5 : 1.3.

The NMR spectrum is shown below.

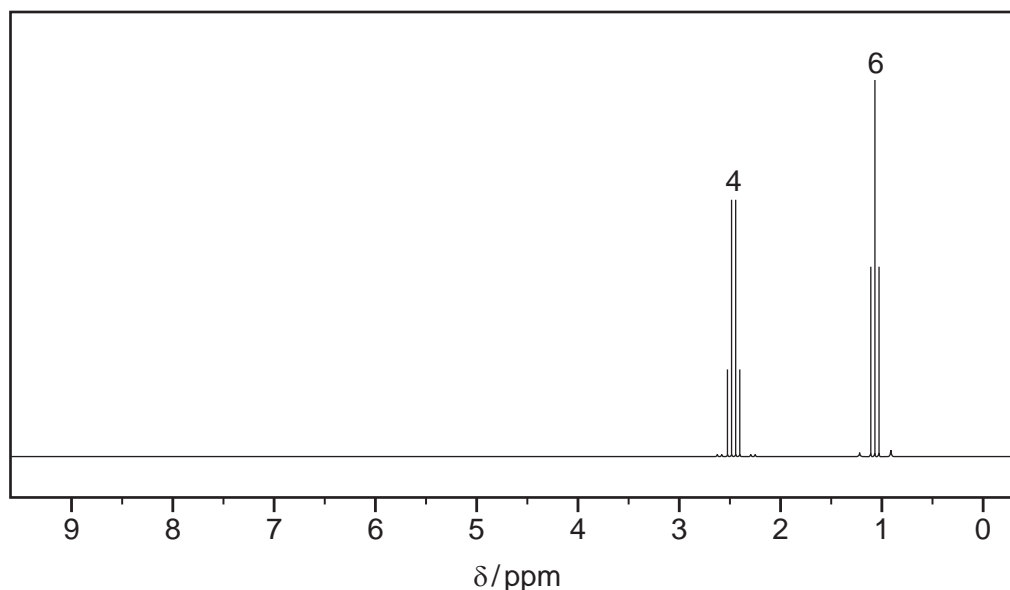

(i) Use the data to determine the number of carbon and hydrogen atoms present in **J**, showing your working.

(ii) Use the information given above and your answer to (i) to identify the other element present in **J**.

.....

(iii) Determine the structure of **J**, explaining how you reach your conclusion.

structure of **J**

explanation .....

.....

[5]

(b) Chromatography is another important analytical technique used in chemistry.

(i) Paper, thin-layer and gas-liquid chromatography rely on different physical methods to separate the components in a mixture. Complete the table indicating the appropriate method on which the technique is based.

| technique                 | physical method |
|---------------------------|-----------------|
| paper chromatography      |                 |
| thin-layer chromatography |                 |
| gas-liquid chromatography |                 |

In paper chromatography, better separation may be achieved by running the chromatogram in one solvent, then turning the paper at right angles and running it in a second solvent. The chromatogram below was produced in this way.

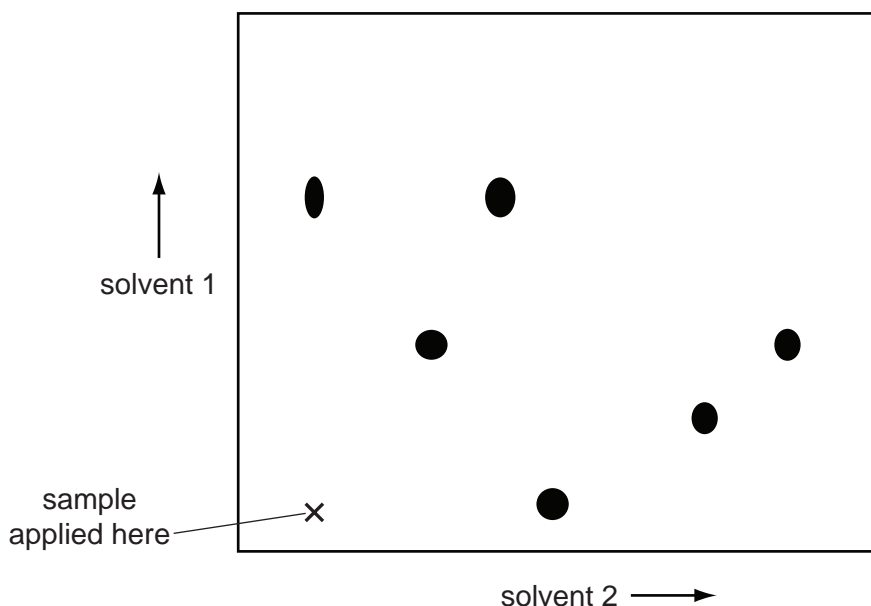

(ii) How many spots were visible **before** solvent 2 was used?

.....

(iii) Ring the spot that did **not** move in solvent 2.

(iv) How many spots travelled further in solvent 2 than they did in solvent 1?

.....

[5]

[Total: 10]





**(b)** Look at the structures of the three polymers and answer the following questions.

**(i)** Suggest why the density of **B** is lower than that of **A**.

.....  
.....

**(ii)** Which polymer will have the weakest forces between chains, and what is the nature of these forces?

.....  
.....

[2]

[Total: 7]





---

Permission to reproduce items where third-party owned material protected by copyright is included has been sought and cleared where possible. Every reasonable effort has been made by the publisher (UCLES) to trace copyright holders, but if any items requiring clearance have unwittingly been included the publisher will be pleased to make amends at the earliest possible opportunity.

University of Cambridge International Examinations is part of the Cambridge Assessment Group. Cambridge Assessment is the brand name of University of Cambridge Local Examinations Syndicate (UCLES), which is itself a department of the University of Cambridge.