



Cambridge International AS & A Level

BIOLOGY

9700/13

Paper 1 Multiple Choice

May/June 2020

1 hour

You must answer on the multiple choice answer sheet.

You will need: Multiple choice answer sheet
Soft clean eraser
Soft pencil (type B or HB is recommended)

INSTRUCTIONS

- There are **forty** questions on this paper. Answer **all** questions.
- For each question there are four possible answers **A, B, C** and **D**. Choose the **one** you consider correct and record your choice in soft pencil on the multiple choice answer sheet.
- Follow the instructions on the multiple choice answer sheet.
- Write in soft pencil.
- Write your name, centre number and candidate number on the multiple choice answer sheet in the spaces provided unless this has been done for you.
- Do **not** use correction fluid.
- Do **not** write on any bar codes.
- You may use a calculator.

INFORMATION

- The total mark for this paper is 40.
- Each correct answer will score one mark. A mark will not be deducted for a wrong answer.
- Any rough working should be done on this question paper.

This document has **20** pages. Blank pages are indicated.



- 1 A student was given a photomicrograph of a cell and told the magnification of the image. The student was asked to calculate the actual size of the cell.

Which row in the table explains how to do this?

	measure the image in	convert to μm by multiplying by	rearrange the formula to
A	cm	1.0×10^4	$\frac{M}{I}$
B	cm	1.0×10^6	$I \times M$
C	mm	1.0×10^3	$\frac{I}{M}$
D	mm	1.0×10^4	$I \times M$

- 2 The electron micrograph shows part of a eukaryotic cell.

Which cell structure is a site of protein synthesis?

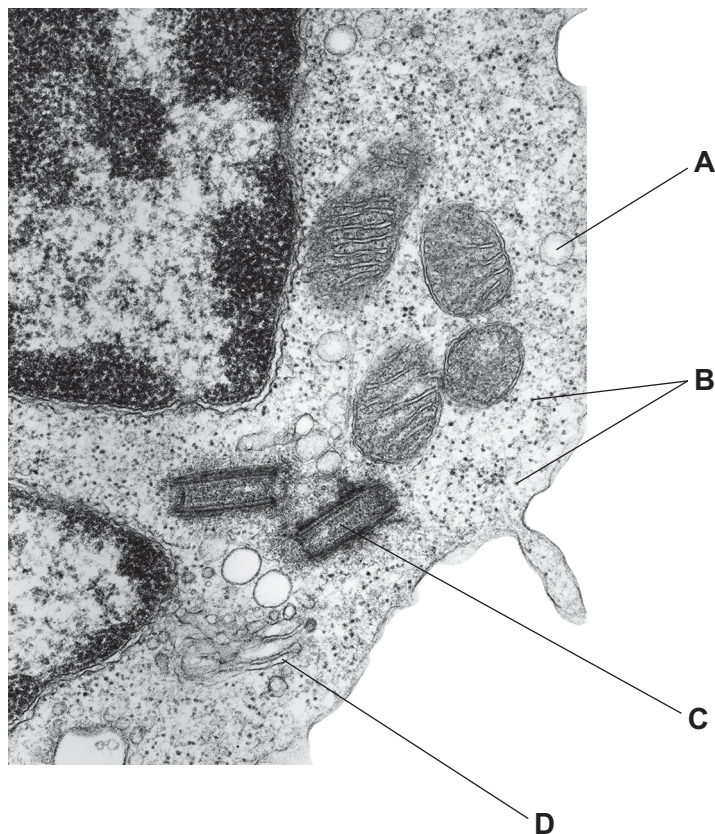

- 3 Some stains can be used to identify cell structures in living cells.

A dilute solution of one stain causes the whole cell to appear blue.

The blue colour rapidly disappears in most cell structures. Those cell structures that release energy stay blue.

Which type of cell structure is likely to stay blue?

- A** endoplasmic reticulum
B Golgi body
C lysosome
D mitochondrion
- 4 A molecule of carbon dioxide is in the centre of a mitochondrion.

Assuming there are no other cell structures in its path, how many phospholipid layers will the carbon dioxide molecule have to pass through in order to leave the cell?

- A** 2 **B** 3 **C** 6 **D** 8

- 5 Which row identifies the type of ribosome found in each of the different structures?

	chloroplast	cytoplasm of eukaryotic cell	prokaryotic cell	mitochondrion
A	70S	70S	80S	70S
B	70S	80S	70S	70S
C	80S	70S	80S	80S
D	80S	80S	70S	80S

- 6 The colour of a positive Benedict's test is due to the formation of copper oxide. The mass of copper oxide is proportional to the mass of reducing sugar present.

Samples of fruit juice were tested for the presence of reducing sugars and non-reducing sugars using the Benedict's test.

The table shows the mass of copper oxide after boiling with Benedict's solution and after acid hydrolysis and boiling with Benedict's solution.

Which sample contained the most **non-reducing** sugar?

	mass of copper oxide / mg	
	after boiling with Benedict's solution	after acid hydrolysis and boiling with Benedict's solution
A	20	20
B	30	45
C	50	55
D	65	75

- 7 Which polysaccharides contain 1, 4 **and** 1, 6 glycosidic bonds?

- 1 amylopectin
- 2 amylose
- 3 cellulose
- 4 glycogen

- A** 1 and 3 **B** 1 and 4 **C** 2 and 3 **D** 4 only

8 The diagram shows a small part of a polypeptide.

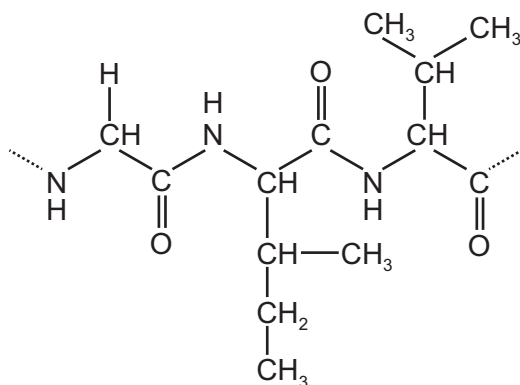

What would the products be if the part shown was completely hydrolysed?

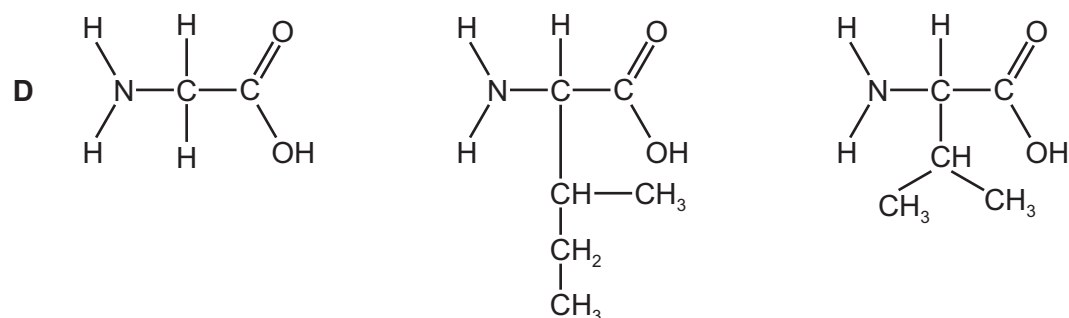
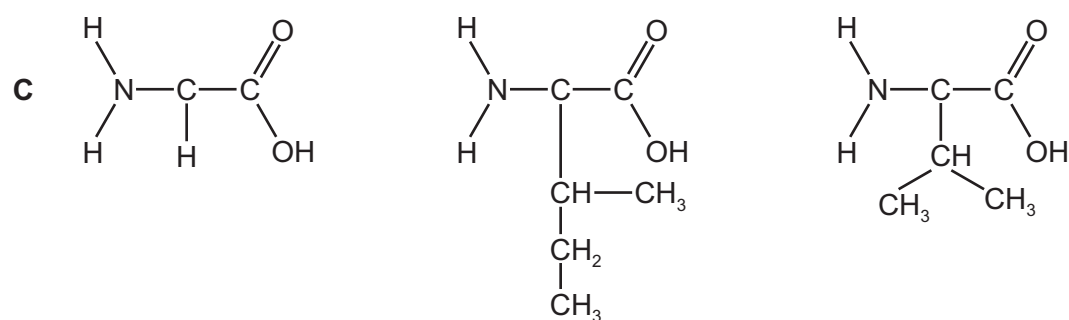
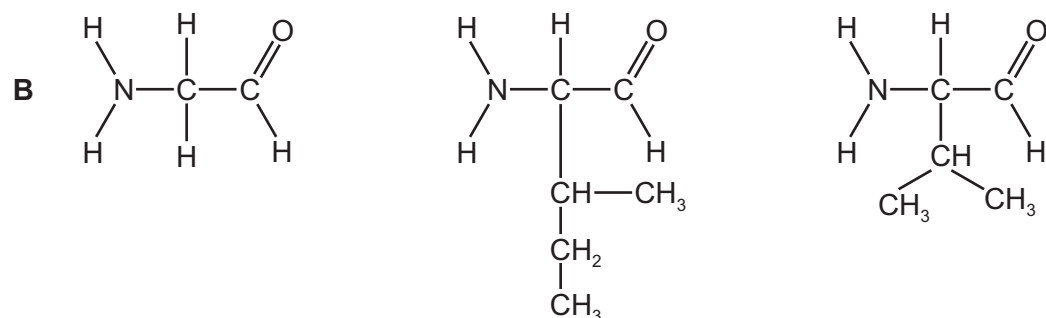
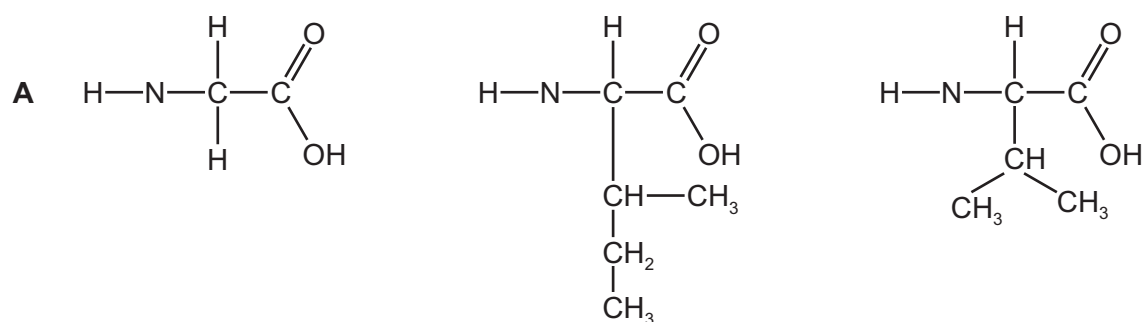

- 9 The enzyme trypsin hydrolyses proteins to amino acids. Trypsin does not function when the pH is very low as its 3D shape would be changed.

What explains this change in 3D shape?

- A Hydrogen ions attach themselves to negatively charged R groups.
- B Hydrogen ions disrupt disulfide bonds.
- C Hydrogen ions increase hydrogen bonding between amino acids.
- D Hydrogen ions reduce the affinity of hydrophilic R groups for water.

- 10 The flow chart shows some of the steps in the formation of collagen.

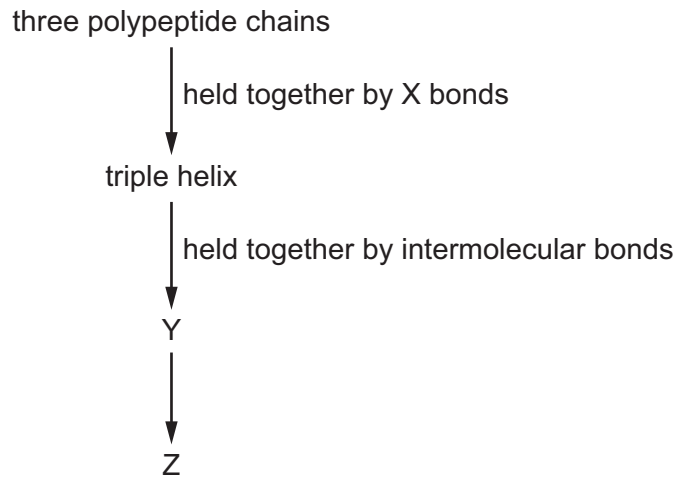

Which row correctly identifies X, Y and Z?

	X	Y	Z
A	disulfide	fibres	fibrils
B	hydrogen	fibrils	fibres
C	hydrogen	microfibrils	fibres
D	peptide and hydrogen	fibres	microfibrils

- 11 Which molecules contain at least two double bonds?

- 1 saturated fatty acid
- 2 collagen
- 3 haemoglobin

- A** 1, 2 and 3 **B** 1 and 2 only **C** 1 and 3 only **D** 2 and 3 only

12 Two experiments, X and Y, were carried out using an enzyme from humans.

Experiment X was carried out at a constant temperature of 37°C. During experiment Y, the temperature was increased from 37°C to 80°C. All other factors were kept the same.

Which graph shows the results?

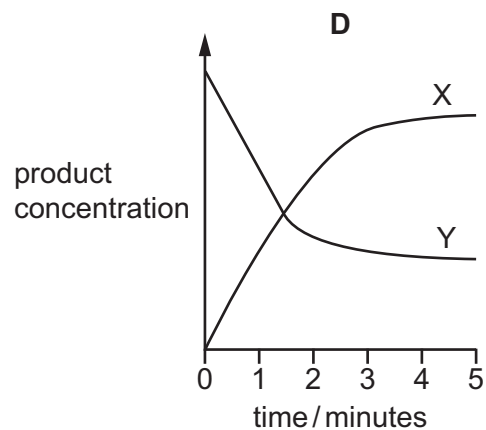
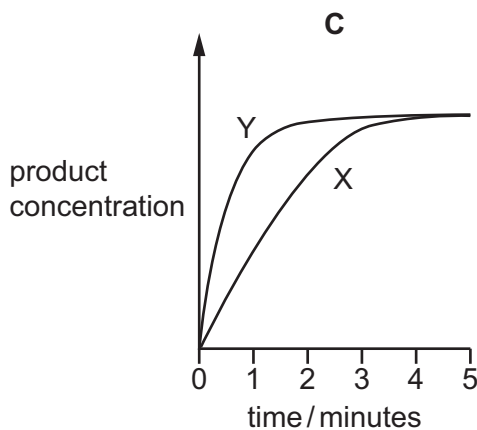
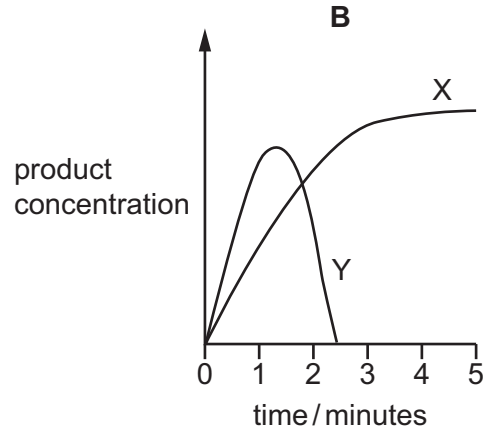
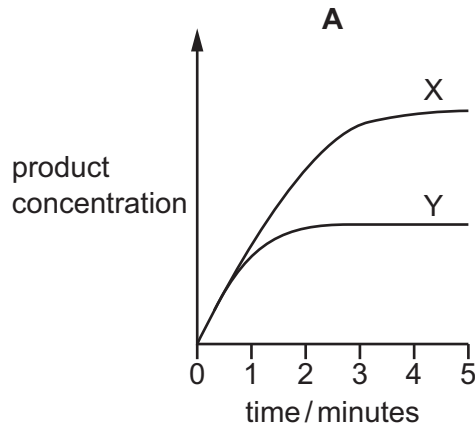

13 What affects the rate of an enzyme-catalysed reaction when in the presence of a non-competitive inhibitor?

- 1 enzyme concentration
- 2 inhibitor concentration
- 3 substrate concentration

A 1, 2 and 3 **B** 1 and 2 only **C** 1 and 3 only **D** 2 and 3 only

14 What describes the fluid-mosaic model of membrane structure?

- A** Cholesterol makes the membrane more fluid.
- B** Fluids can cross the membrane by diffusion or osmosis.
- C** Proteins act as receptors for cell signalling.
- D** Proteins and phospholipids move and change places.

- 15** Blocks of agar are stained with a pH indicator and used to investigate the diffusion of an acid solution.

Which block would completely change colour the fastest?

- A** 1mm × 1mm × 1mm
- B** 1mm × 0.25mm × 0.25mm
- C** 1mm × 0.5mm × 0.5mm
- D** 2mm × 0.5mm × 0.5mm

- 16** The diagram shows the water potential of three adjacent plant cells, P, Q and R.

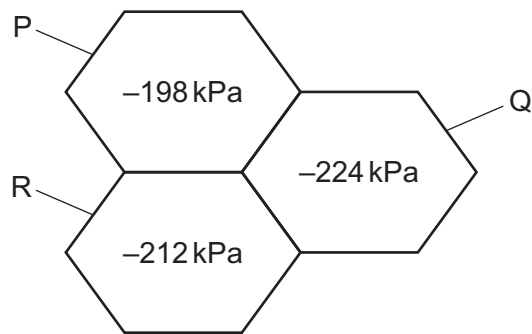

Which shows the net movement of water between cells P, Q and R?

- A** P → Q and P → R and R → Q
- B** P → Q and P → R
- C** Q → P and Q → R and R → P
- D** Q → P and R → P

17 Which row correctly describes parts of chromosome structure present during mitosis?

	centromere	chromatid	telomere
A	region of a chromosome with no DNA	single DNA polynucleotide with histone proteins	region of DNA with many cytosine and guanine bases
B	region of non-coding DNA holding two chromatids together	double-stranded DNA molecule with histone proteins	region of DNA with many short repeated sequences of bases
C	region of DNA with no histone proteins that allows separation of chromatids during anaphase	DNA molecule coiled round histone proteins to form a chain of nucleosomes	region of DNA with no proteins that protects the end of a chromatid
D	region that attaches to spindle microtubules and divides during prophase	one of two identical DNA molecules that was replicated during interphase	region of non-coding DNA holding the ends of the chromatids together

18 The diagram shows the relative time taken for each stage in the cell cycle.

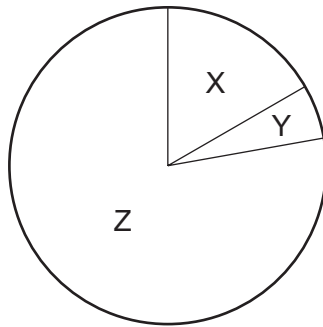

Which row identifies the correct sequence of the stages in the cell cycle?

	cytokinesis	interphase	mitosis
A	X	Y	Z
B	X	Z	Y
C	Y	Z	X
D	Z	X	Y

- 19** Scientists have made a nucleic acid, HNA, that has a sugar with the same number of carbon atoms as glucose instead of deoxyribose. Although genetic information can be stored by HNA, naturally occurring DNA polymerase cannot replicate HNA.

Which statements could explain why naturally occurring DNA polymerase cannot replicate HNA?

- 1 DNA polymerase cannot form bonds between the sugars of two HNA nucleotides.
- 2 DNA polymerase cannot form hydrogen bonds between two HNA nucleotides.
- 3 HNA nucleotides do not fit into the active site of DNA polymerase.
- 4 The shape of an HNA nucleotide is slightly larger than that of a DNA nucleotide.

A 1, 2, 3 and 4 **B** 1 and 4 only **C** 2 and 3 only **D** 3 and 4 only

- 20** Which statements about the nucleotide containing uracil are correct?

- 1 Uracil is a pyrimidine.
- 2 The carbohydrate is always ribose.
- 3 Base pairing occurs with 3 hydrogen bonds.

A 1, 2 and 3 **B** 1 and 2 only **C** 1 and 3 only **D** 2 and 3 only

- 21** DNA replication involves several stages.

- 1 Each strand of DNA double helix acts as a template for the opposite strand.
- 2 The enzyme DNA polymerase links bases together.
- 3 Hydrogen bonds between bases A and T and between C and G are broken.

Which statements about DNA replication are correct?

A 1, 2 and 3 **B** 1 and 2 only **C** 1 and 3 only **D** 3 only

- 22** The sequence of bases in mRNA for the first eight amino acids in the β -polypeptide of adult haemoglobin is:

GUG–CAC–CUG–ACU–CCU–GAG–GAG–AAG.

In haemoglobin C, which is a cause of haemolytic anaemia, the sequence is:

GUG–CAC–CUG–ACU–CCU–AAG–GAG–AAG.

The coding for seven of the amino acids is listed.

amino acid	DNA triplet
glu	CTC
his	GTG
leu	GAG
lys	TTC
pro	GGA
thr	TGA
phe	AAG

Which change occurs to the amino acid sequence of adult haemoglobin to make haemoglobin C?

- A** Histidine is changed to leucine.
 - B** Proline is changed to threonine.
 - C** Glutamic acid is changed to lysine.
 - D** Leucine is changed to phenylalanine.
- 23** Some antibiotics kill prokaryotes by binding to RNA polymerase.

What effect will this have on protein synthesis?

- A** Codons on mRNA will be unable to hydrogen bond to complementary anticodons on tRNA.
- B** Condensation reactions joining RNA nucleotides will not take place to form mRNA.
- C** DNA will not unwind and unzip to allow for base pairing with RNA nucleotides.
- D** Free RNA nucleotides will not base pair to exposed bases on the DNA template strand.

24 The diagrams show transverse sections through parts of plants.

Which of the labelled regions contains cells which are dead?

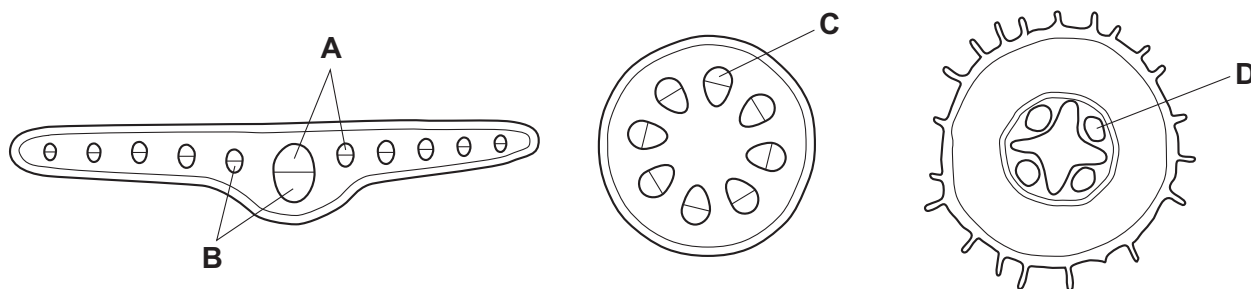

25 The diagram shows the distribution of tissues in part of a transverse section through a plant organ.

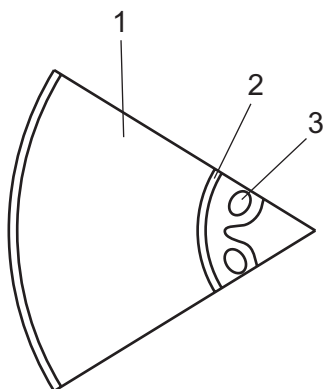

Which row correctly identifies tissues 1, 2 and 3?

	1	2	3
A	cortex	endodermis	phloem
B	cortex	epidermis	xylem
C	endodermis	epidermis	pith
D	pith	endodermis	phloem

26 The circumference of a tree stem was measured continually for 48 hours.

The results are shown on the chart recording.

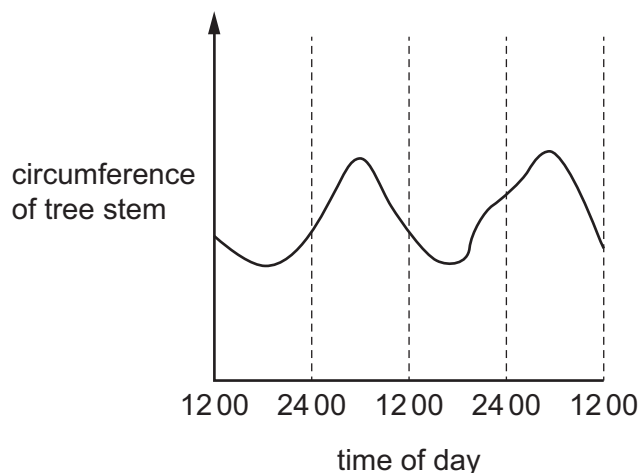

What explains the changes in circumference recorded during the 48 hours?

- A Adhesion forces decrease during the night.
 - B Cohesive tension forces increase during the day.
 - C Mass flow of sucrose increases during the night.
 - D Root pressure decreases during the day.
- 27 Which description of movement in phloem is correct?
- A Adding sucrose to a sieve tube element increases its water potential so that water enters and increases the hydrostatic pressure.
 - B At a sink, such as a storage organ, sucrose is removed from a sieve tube element and polymerised into starch.
 - C At a source, such as a photosynthesising leaf, sucrose enters a sieve tube element by facilitated diffusion.
 - D At a source, sucrose is loaded into a companion cell using a protein that carries both hydrogen ions and sucrose molecules.

28 Which statements about blood vessels are correct?

- 1 Collagen fibres in the walls of arteries and veins prevent overstretching.
- 2 Elastic fibres in large arteries allow stretching during ventricular systole.
- 3 Smooth muscle in arteries controls the distribution of blood to different parts of the body.
- 4 Veins have valves because their walls are thin.

- A** 1, 2, 3 and 4
B 1, 2 and 3 only
C 2 and 4 only
D 3 and 4 only

29 The photomicrograph shows three white blood cells labelled X, Y and Z.

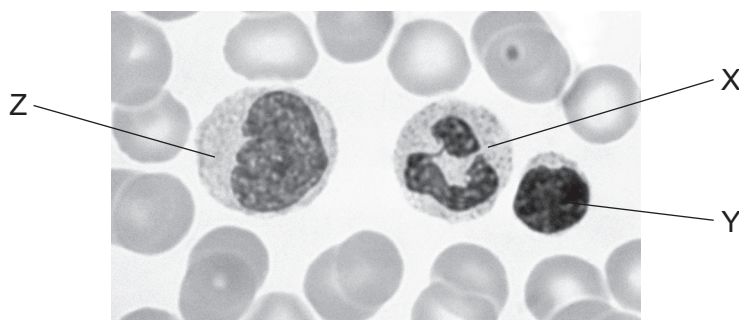

Which row correctly identifies these cells?

	cell X	cell Y	cell Z
A	lymphocyte	neutrophil	monocyte
B	lymphocyte	monocyte	neutrophil
C	monocyte	lymphocyte	neutrophil
D	neutrophil	lymphocyte	monocyte

30 The enzyme carbonic anhydrase catalyses the reaction:

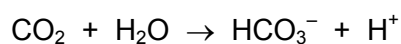

Which statements describe the role of the enzyme carbonic anhydrase?

- 1 to speed up the decrease in pH of blood in the presence of carbon dioxide
- 2 to facilitate the Bohr effect in haemoglobin
- 3 to speed up the reaction between carbon dioxide and water

- A** 1, 2 and 3 **B** 1 only **C** 2 only **D** 3 only

- 31 The graph shows the oxygen dissociation curves of adult haemoglobin at two partial pressures of carbon dioxide W and X.

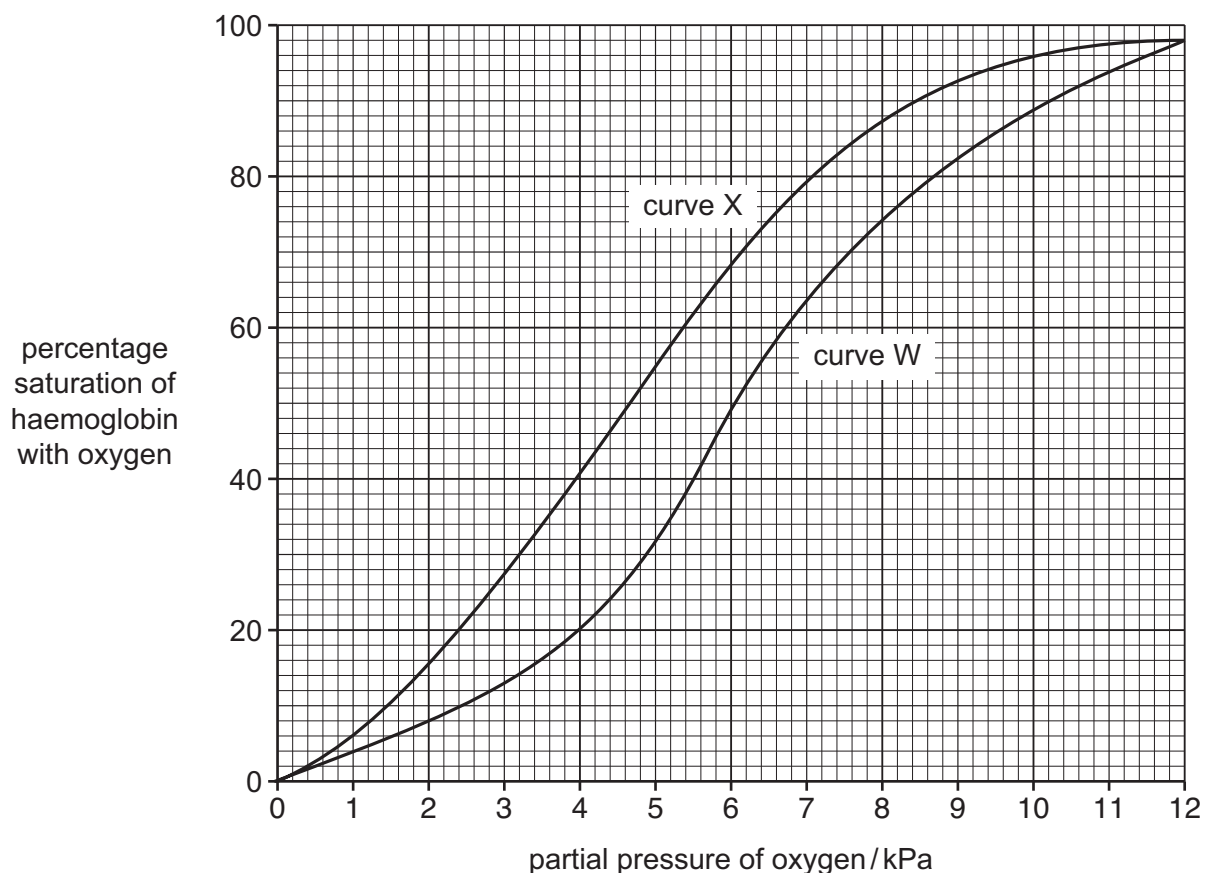

Which pair of statements are correct?

- 1 Curve W shows the oxygen dissociation curve at a higher concentration of carbon dioxide than curve X.
- 2 Curve X shows the oxygen dissociation curve at a higher concentration of carbon dioxide than curve W.
- 3 At a partial pressure of oxygen of 7.0 kPa the haemoglobin from curve W has a higher affinity for oxygen than haemoglobin from curve X.
- 4 At a partial pressure of oxygen of 7.0 kPa the haemoglobin from curve X has a higher affinity for oxygen than haemoglobin from curve W.

- A** 1 and 3 **B** 1 and 4 **C** 2 and 3 **D** 2 and 4

- 32 A person has two blood tests one month apart. The number of each type of cell in a fixed sample size is counted.

type of cell	first test	after one month
red blood cells	normal	higher
lymphocytes	normal	higher

What could this suggest about the person based on the results after one month?

	body temperature higher	moved to higher altitude	ATP synthesis in cells is higher
A	no	no	yes
B	no	yes	no
C	yes	no	no
D	yes	yes	yes

- 33 A student was asked to describe the differences between four microscope slides of sections taken from different parts of the gas exchange system.

slide 1 not present: cartilage, glands

present: few goblet cells, ciliated epithelial cells, smooth muscle

slide 2 present: incomplete cartilage rings, glands, goblet cells, ciliated epithelial cells, smooth muscle

slide 3 not present: cartilage, glands, goblet cells, smooth muscle

present: squamous epithelial cells

slide 4 present: plates of cartilage, glands, goblet cells, ciliated epithelial cells, smooth muscle

Which is the correct identification of the parts of the gas exchange system?

	slide 1	slide 2	slide 3	slide 4
A	alveolus	bronchiole	bronchus	trachea
B	bronchiole	bronchus	alveolus	trachea
C	bronchiole	trachea	alveolus	bronchus
D	bronchus	trachea	bronchiole	alveolus

34 Cigarette smoke contains carbon monoxide, nicotine and tar.

Which row correctly describes how these substances affect the body?

	carbon monoxide	nicotine	tar
A	stimulates nerve endings	stimulates the nervous system to reduce the diameter of the arteries	leads to obstructive lung disease
B	forms carbaminohaemoglobin	increases the risk of blood clots	blocks goblet cells
C	causes increased blood pressure	combines with haemoglobin	increases the risk of blood clots
D	combines with haemoglobin	stimulates nerve endings	carcinogenic

35 Chronic obstructive pulmonary disease (COPD) includes chronic bronchitis and emphysema.

In what order do these events occur as emphysema develops?

- 1 Macrophages move into alveolar air spaces.
- 2 Tar paralyses cilia.
- 3 Macrophages secrete elastase.
- 4 Bacteria accumulate in alveoli.

- A** 2 → 4 → 1 → 3
- B** 2 → 4 → 3 → 1
- C** 4 → 1 → 3 → 2
- D** 4 → 2 → 3 → 1

36 If someone smokes cigarettes, what will be the immediate result of this action on the red blood cells?

- A** Carbon monoxide will combine with the globin in haemoglobin.
- B** Carbon monoxide replaces carbon dioxide in carbaminohaemoglobin.
- C** Less oxyhaemoglobin will form.
- D** More haemoglobin acid will be formed.

37 What is correct for tuberculosis (TB)?

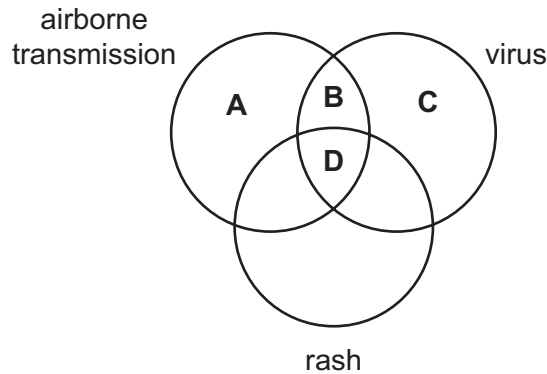

38 Some common antibiotics are listed. The action of each antibiotic is described.

- 1 rifampicin – inhibits RNA polymerase
- 2 streptomycin – inhibits 70S ribosomes
- 3 neomycin – inhibits DNA synthesis
- 4 ampicillin – inhibits peptidoglycan synthesis

Which of these antibiotics will affect the activities of bacterial cells **only**?

- A 1, 2, 3 and 4
- B 1, 2 and 3 only
- C 2 and 4 only
- D 4 only

39 Which method of gaining immunity can be described as natural active immunity?

- A feeding on colostrum
- B inhaling the chicken pox virus
- C injection with antibodies
- D through the placenta

40 Which statements correctly explain why smallpox has been eradicated, but not malaria or cholera?

- 1 Cholera vaccines provide only short-term immunity.
- 2 Plasmodium antigens change during the life cycle.
- 3 Smallpox antigens remain stable.
- 4 Vaccines only work against viruses.

- A 1, 2 and 3
- B 1, 2 and 4
- C 1, 3 and 4
- D 2, 3 and 4

BLANK PAGE

Permission to reproduce items where third-party owned material protected by copyright is included has been sought and cleared where possible. Every reasonable effort has been made by the publisher (UCLES) to trace copyright holders, but if any items requiring clearance have unwittingly been included, the publisher will be pleased to make amends at the earliest possible opportunity.

To avoid the issue of disclosure of answer-related information to candidates, all copyright acknowledgements are reproduced online in the Cambridge Assessment International Education Copyright Acknowledgements Booklet. This is produced for each series of examinations and is freely available to download at www.cambridgeinternational.org after the live examination series.

Cambridge Assessment International Education is part of the Cambridge Assessment Group. Cambridge Assessment is the brand name of the University of Cambridge Local Examinations Syndicate (UCLES), which itself is a department of the University of Cambridge.