



Cambridge IGCSE™

CANDIDATE
NAME

CENTRE
NUMBER

--	--	--	--	--

CANDIDATE
NUMBER

--	--	--	--



COMBINED SCIENCE

0653/43

Paper 4 Theory (Extended)

May/June 2024

1 hour 15 minutes

You must answer on the question paper.

No additional materials are needed.

INSTRUCTIONS

- Answer **all** questions.
- Use a black or dark blue pen. You may use an HB pencil for any diagrams or graphs.
- Write your name, centre number and candidate number in the boxes at the top of the page.
- Write your answer to each question in the space provided.
- Do **not** use an erasable pen or correction fluid.
- Do **not** write on any bar codes.
- You may use a calculator.
- You should show all your working and use appropriate units.

INFORMATION

- The total mark for this paper is 80.
- The number of marks for each question or part question is shown in brackets [].
- The Periodic Table is printed in the question paper.

This document has **24** pages. Any blank pages are indicated.

1 (a) Fig. 1.1a and Fig. 1.1b are diagrams of different flowers.

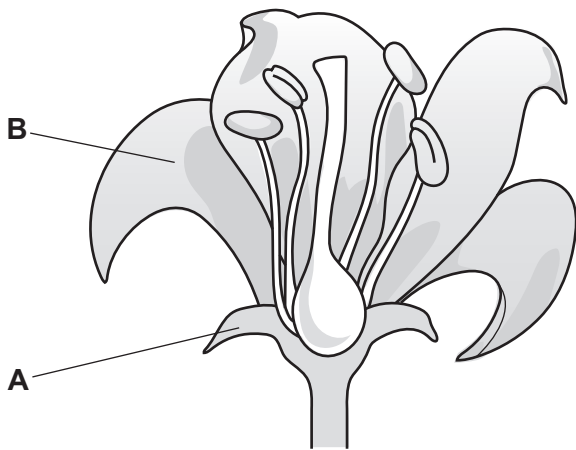

Fig. 1.1a

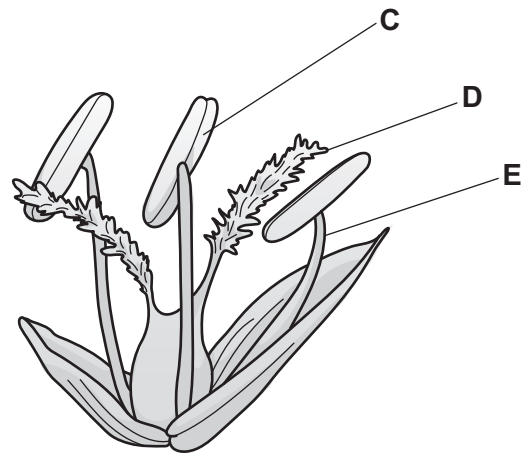

Fig. 1.1b

(i) Table 1.1 shows some of the labels in Fig. 1.1a and Fig. 1.1b, the name of the part and its function.

Complete Table 1.1.

Table 1.1

label	name	function
.....	sepal
C	produces
.....	site of pollination

[3]

(ii) Describe one **visible** feature in Fig. 1.1a that shows the flower is insect-pollinated.

..... [1]

(b) Fig. 1.2 is a diagram of a sperm cell.

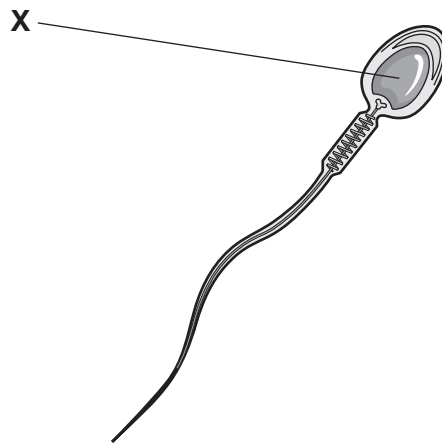

Fig. 1.2

(i) State **two** adaptive features of sperm cells.

1

2

[2]

(ii) Describe what happens during fertilisation to the structure labelled **X** in Fig. 1.2.

.....

..... [2]

[Total: 8]

2 Oxides of nitrogen are pollutant gases formed in car engines. Nitrogen monoxide, NO, and nitrogen dioxide, NO₂, are both oxides of nitrogen.

(a) Nitrogen, N₂, and oxygen, O₂, react together in car engines to make nitrogen monoxide, NO.

Nitrogen monoxide reacts with oxygen to form nitrogen dioxide, NO₂.

The energy level diagrams for these reactions are shown in Fig. 2.1 and Fig. 2.2.

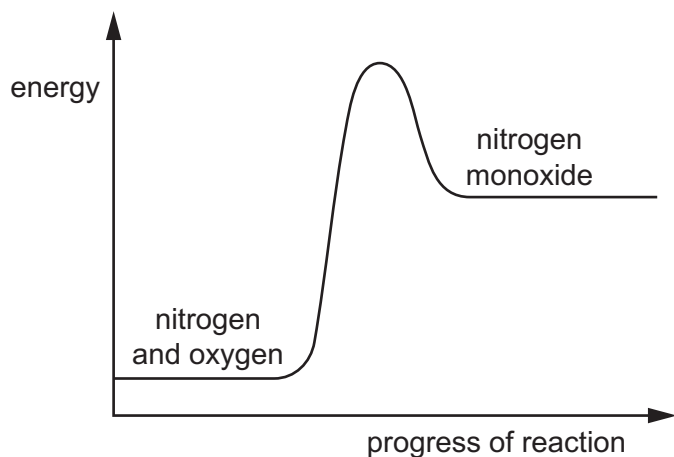

Fig. 2.1

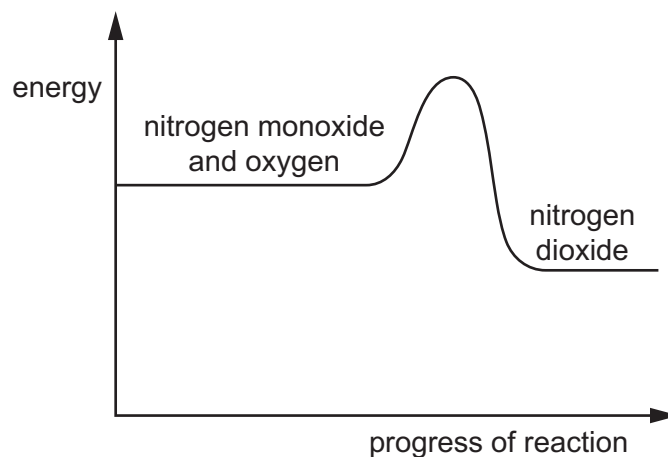

Fig. 2.2

(i) Complete the energy level diagrams shown in Fig. 2.1 and Fig. 2.2 by labelling:

- the activation energy
- the energy change of reaction.

[3]

(ii) The following statements are about the reactions shown in Fig. 2.1 and Fig. 2.2.

Put **one** tick (✓) for each statement to show if it is true or false.

statement	true	false
The reaction between nitrogen and oxygen is exothermic.		
When nitrogen monoxide reacts with oxygen, the energy given out is greater than the energy taken in.		
Both reactions involve breaking bonds.		
Both reactions involve elements reacting together to form compounds.		

[2]

(iii) Write the balanced symbol equation for the reaction between nitrogen oxide, NO, and oxygen, O₂, to make nitrogen dioxide, NO₂.

..... [1]

(b) Oxides of nitrogen are simple molecules.

Explain why oxides of nitrogen have low boiling points.

Use ideas about forces and energy in your answer.

.....
.....
..... [2]

[Total: 8]

- 3 Fig. 3.1 shows a television (TV) connected to a satellite dish. The satellite dish receives microwave signals from a satellite above the Earth.

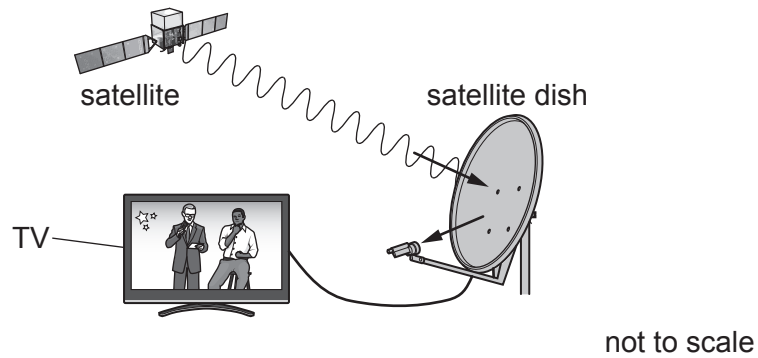

Fig. 3.1

- (a) (i) On Fig. 3.2, write microwaves in the correct place in the electromagnetic spectrum.

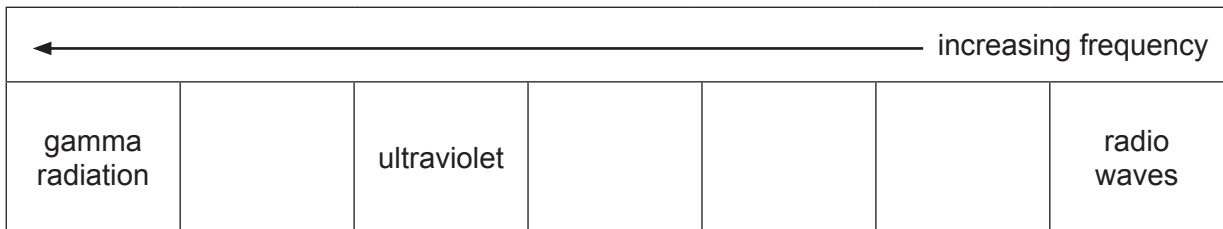

Fig. 3.2

[1]

- (ii) State **one** danger of ultraviolet radiation.

..... [1]

- (b) The microwave signal travels from the satellite to the satellite dish at a speed of 3.0×10^5 km/s.

- (i) The satellite is a distance of 37 000 km from the satellite dish.

Calculate the time taken by the microwave signal to travel from the satellite to the satellite dish.

time = s [2]

(ii) The microwave signal from the satellite has a frequency of 12×10^9 Hz.

Calculate the wavelength in metres of the microwave signal.

wavelength = m [3]

[Total: 7]

4 (a) Fig. 4.1 shows a model of the alimentary canal and associated organs of humans.

The model is viewed from the back.

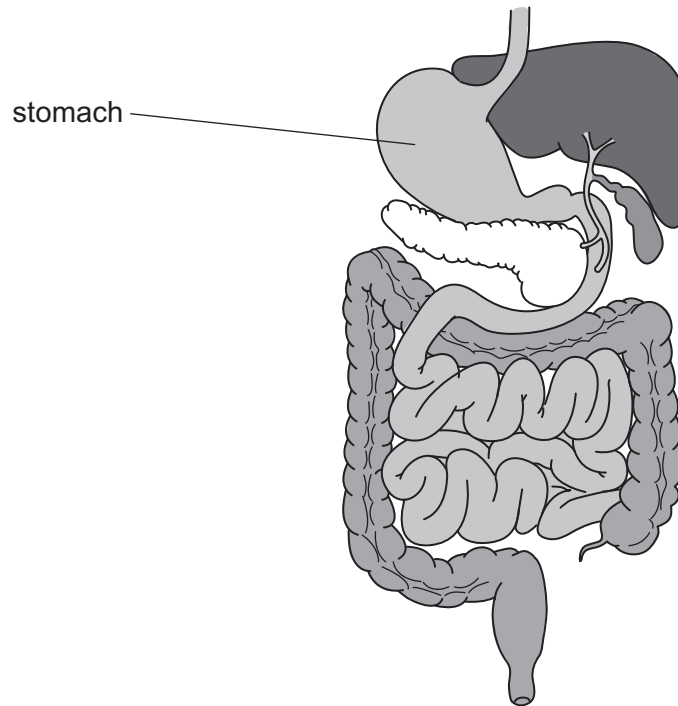

Fig. 4.1

(i) On Fig. 4.1, draw a label line and the letter **P** to identify the pancreas. [1]

(ii) Amylase is an enzyme in the alimentary canal.

Explain why amylase does **not** break down proteins.

.....
.....
..... [2]

(iii) State the name of the product when proteins are digested.

..... [1]

(b) Vitamins and minerals are absorbed into blood capillaries in the alimentary canal.

(i) A diet that lacks vitamin D is a cause of vitamin D deficiency in humans.

State **one other** cause of vitamin D deficiency in humans.

..... [1]

(ii) Describe **one** effect of vitamin D deficiency in humans.

..... [1]

(iii) Explain how capillaries are adapted to their function.

.....
.....
..... [2]

[Total: 8]

5 Zinc and some zinc compounds react with dilute acids to make salts.

(a) (i) Complete the word equations for the following reactions.

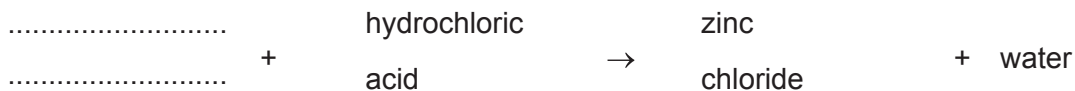
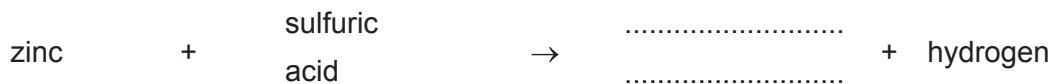

[2]

(ii) Identify **two** covalent substances shown in the equations in (a)(i).

1

2

[2]

(b) A metal carbonate reacts with a dilute acid to form a salt and two other products.

Identify the **two other** products formed in the reaction.

1

2

[2]

(c) Describe how the pH number of a sample of dilute sulfuric acid is determined using an indicator.

.....

.....

..... [2]

(d) Some soils are acidic.

Describe how the acidity in soils is controlled.

.....

..... [1]

[Total: 9]

- 6 Fig. 6.1 shows three forces, **Q**, **R** and **P**, acting on a bus moving along a level road at constant speed.

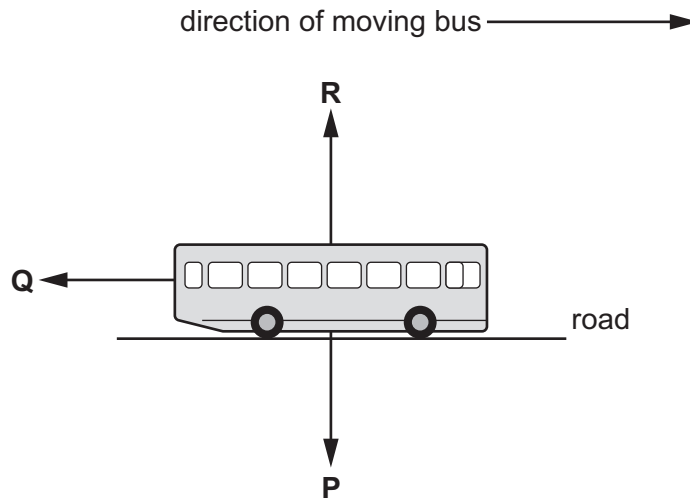

Fig. 6.1

- (a) The driving force acting on the bus is **not** shown on Fig. 6.1.
- (i) On Fig. 6.1, draw an arrow labelled **S** to represent the driving force acting on the bus. [1]
- (ii) State the cause of the force labelled **Q**.
- [1]

- (b) The mass of the bus is 7500 kg.
- The gravitational force on unit mass is 10 N/kg.
- Explain why the force labelled **R** must be 75 000 N.
-
-
- [2]

- (c) Fig. 6.2 shows a speed–time graph of the motion of a bus on a journey between two bus stops.

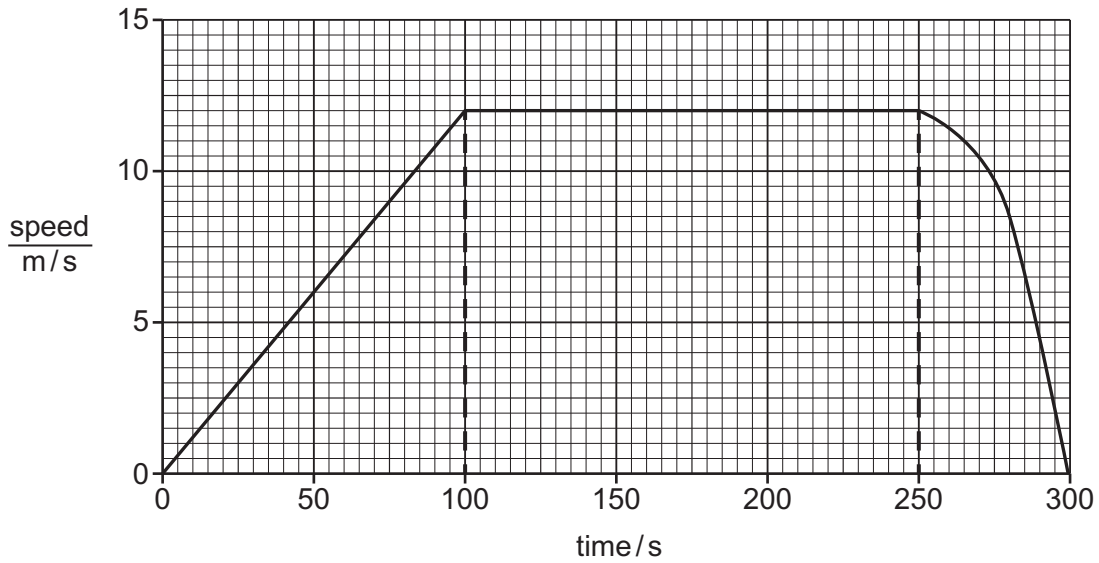

Fig. 6.2

- (i) Calculate the acceleration of the bus as it starts the journey.
Give the units of your answer.

acceleration = units [3]

- (ii) Use Fig. 6.2 to calculate the distance in metres travelled by the bus before it begins to slow down.

distance = m [3]

- (iii) The total distance between the bus stops is 2.65 km.

Use your answer to (c)(ii) to find the distance in metres travelled by the bus while it is decelerating.

distance = m [1]

[Total: 11]

7 (a) Fig. 7.1 is a diagram of a cross-section through a leaf.

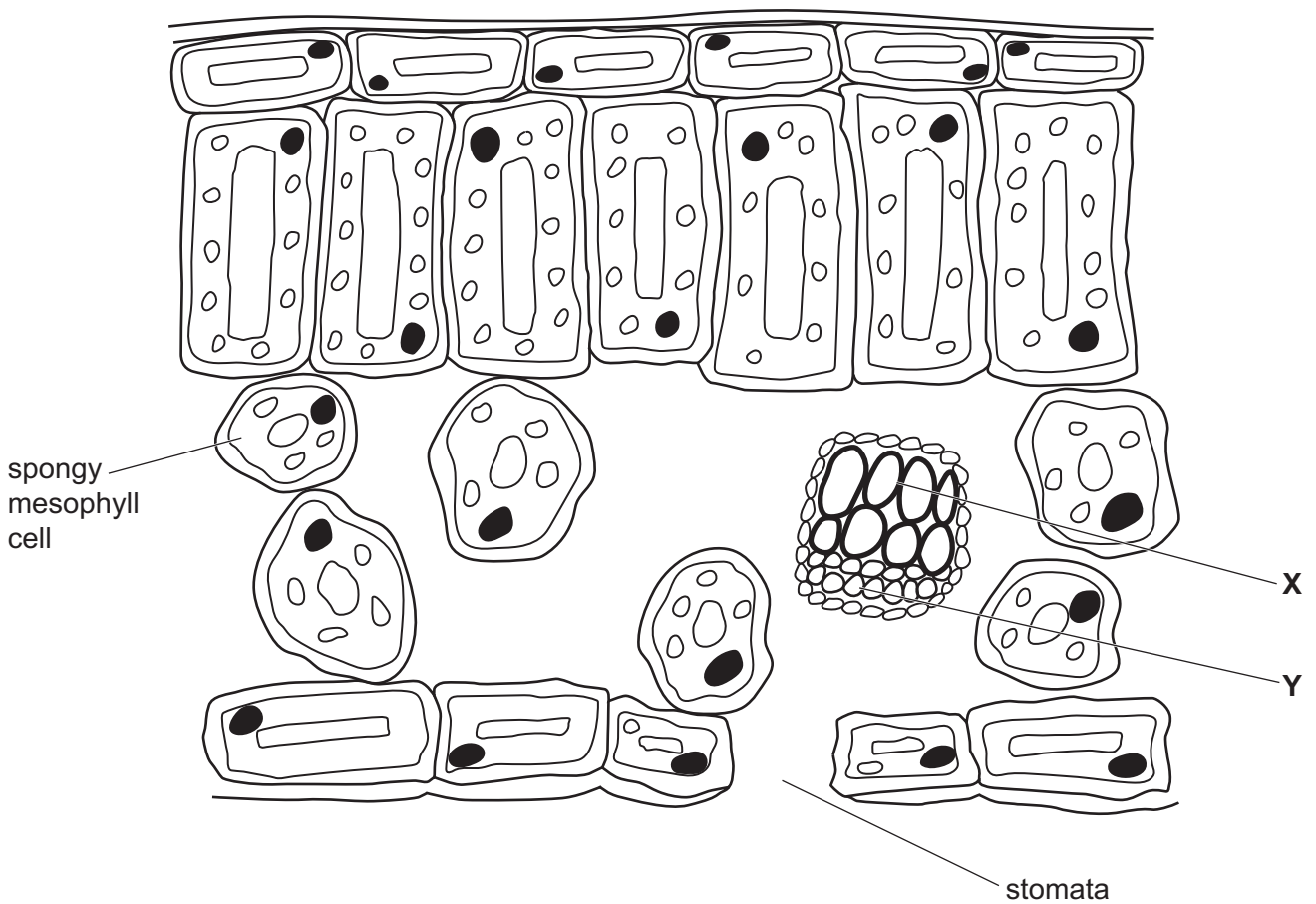

Fig. 7.1

(i) State **one** way the function of X and Y in Fig. 7.1 is similar and **one** way their function is different.

similar

.....

different

.....

[2]

(ii) Describe how water moves from the surface of the spongy mesophyll cells to outside the stomata.

.....

.....

.....

.....

.....

..... [3]

(b) Plants produce a chemical called auxin.

Complete these sentences about auxin.

Auxin is made in the shoot

Auxin then spreads through the shoot, where it causes growth by stimulating cell

Auxin is unequally distributed in response to and

[3]

(c) Plants are usually the producer in a food web.

Fig. 7.2 shows a food web with a different producer.

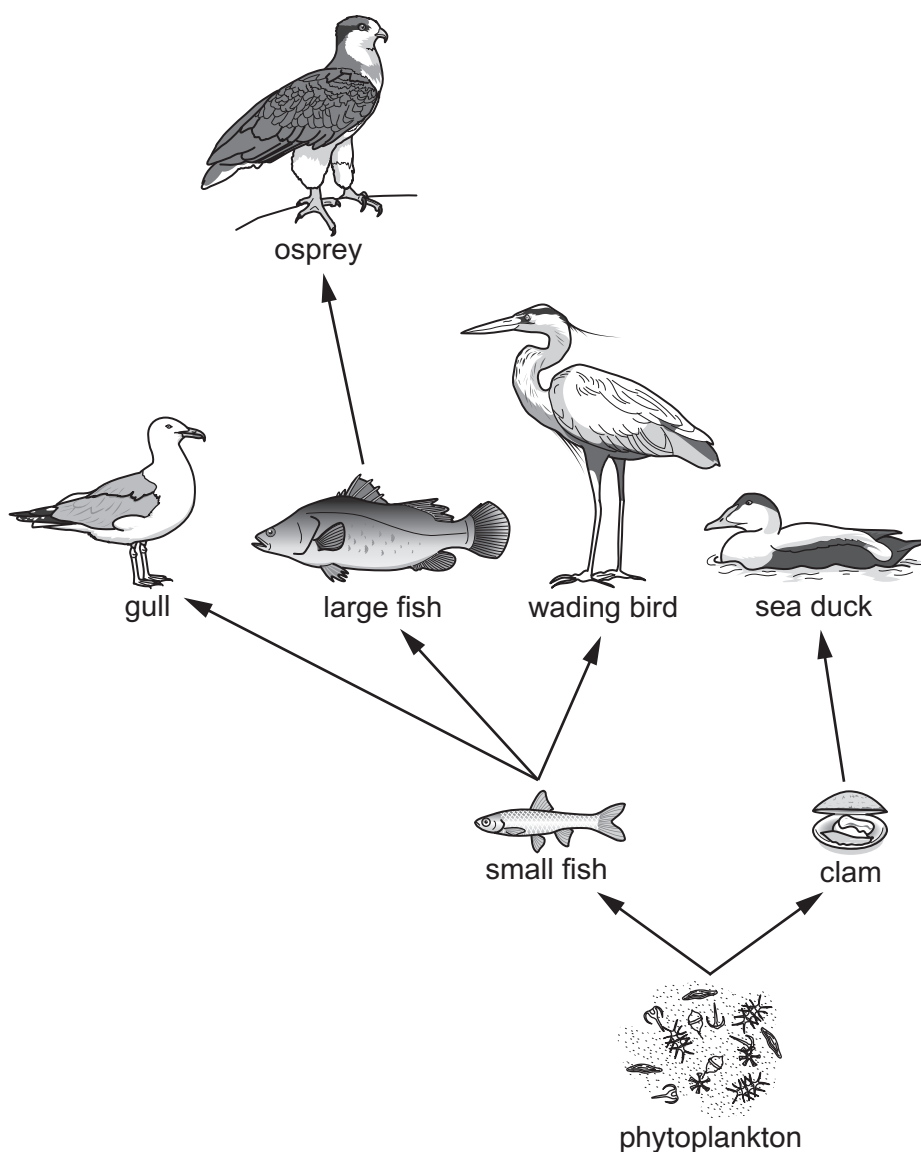

Fig 7.2

(i) Identify **all** the organisms in Fig 7.2 that occupy trophic level 2.

..... [1]

- (ii) Circle all the **bold** words in the sentences about the osprey from Fig. 7.2 which make the sentences correct.

The osprey is a **secondary / tertiary** consumer and is a **carnivore / herbivore**.

This is because the osprey eats **large / small** fish.

[2]

[Total: 11]

8 The structures of ethene and ethane are shown in Fig. 8.1.

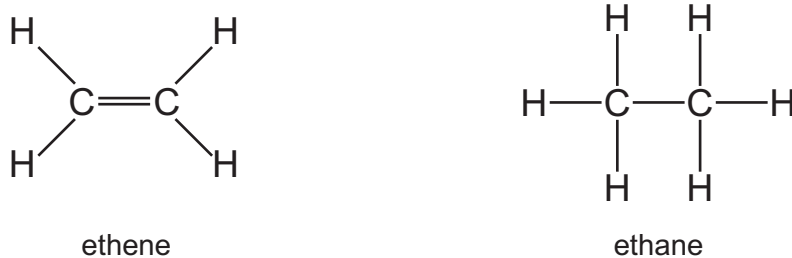

Fig. 8.1

(a) Ethene is a member of the alkene homologous series.

All alkenes are hydrocarbons with the same general formula.

(i) State **one other** similarity between all members of the alkene homologous series.

.....
 [1]

(ii) State the general formula for alkenes and for alkanes.

alkenes

alkanes [2]

(b) Many ethene monomer units react together in addition polymerisation to form poly(ethene).

Draw the structure of a poly(ethene) molecule to show the part formed from **three** ethene monomer units.

[2]

(c) Cracking produces ethene from larger molecules.

The cracking of molecule **A** forms a molecule of ethene and a molecule of compound **B**, as shown in Fig. 8.2.

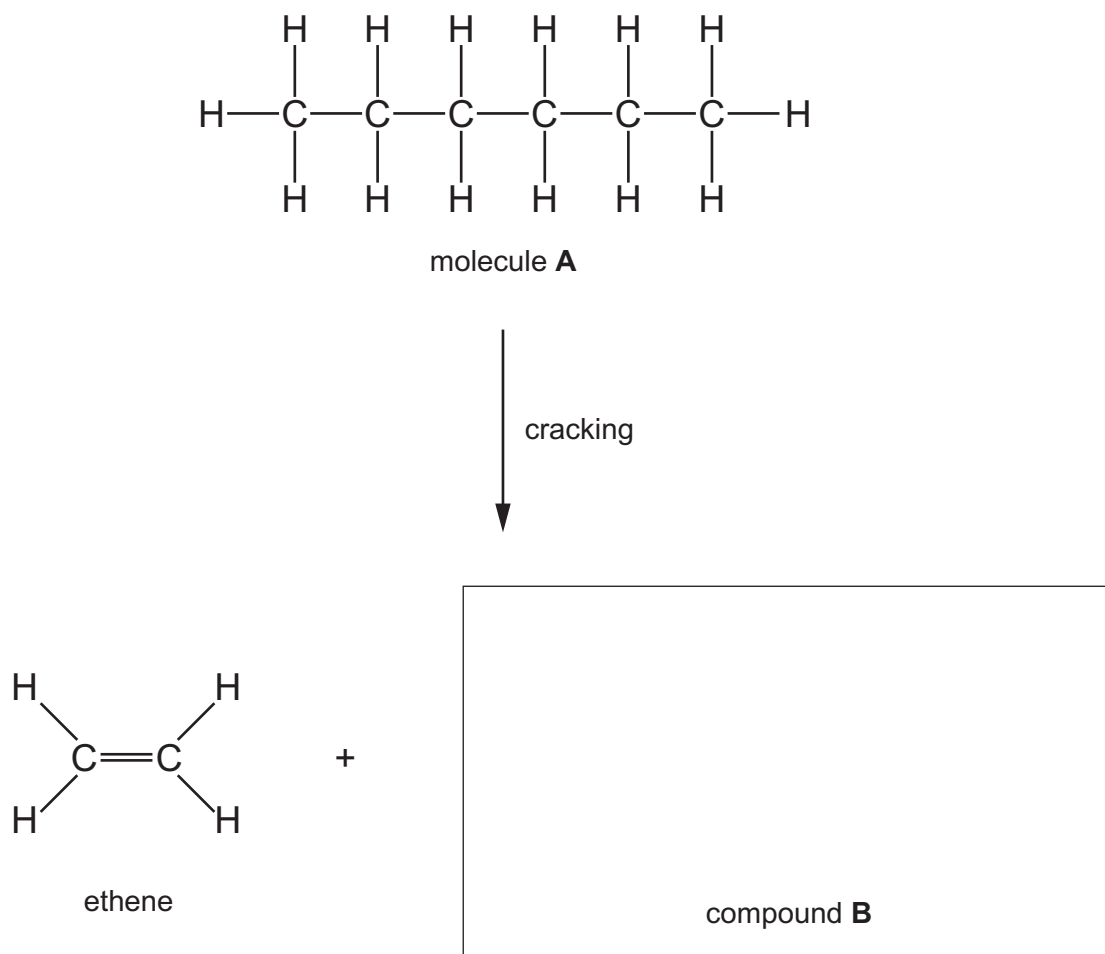

Fig. 8.2

(i) Complete Fig. 8.2 by drawing the structure of compound **B**. [2]

(ii) State the conditions required for cracking.

..... and [2]

[Total: 9]

- 9 Fig. 9.1 shows a simple circuit containing two identical lamps.

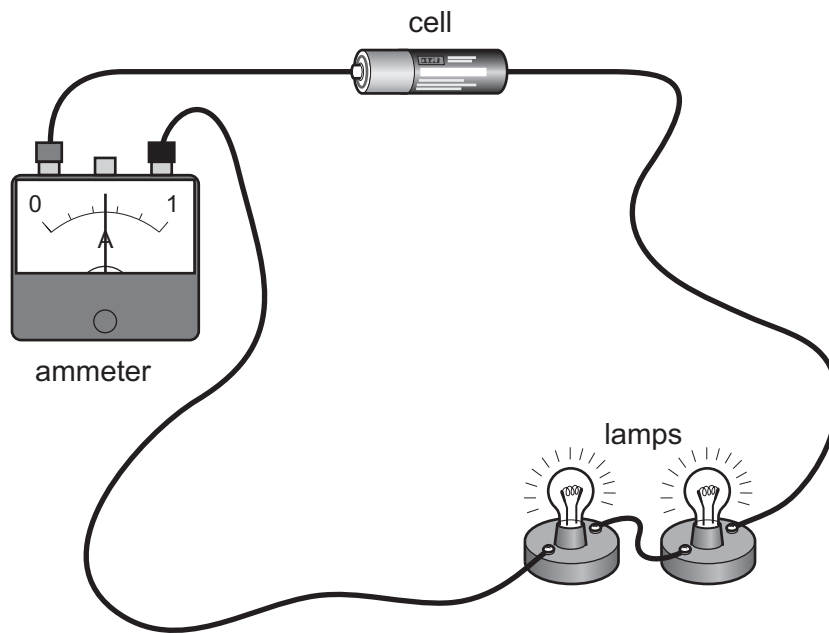

Fig. 9.1

- (a) Complete these sentences.

Potential difference is measured in units called

The current in the circuit is a flow of

[2]

- (b) The cell produces a total e.m.f. of 2.4V. There is a current of 0.50A in the circuit.

- (i) Calculate the power supplied by the cell.

power = W [2]

- (ii) The cell in Fig. 9.1 has a total charge of 9000 C. Calculate the maximum time in hours for which the cell can produce a current of 0.5A.

time = h [3]

(c) Fig. 9.2 shows the same circuit components connected in a different arrangement.

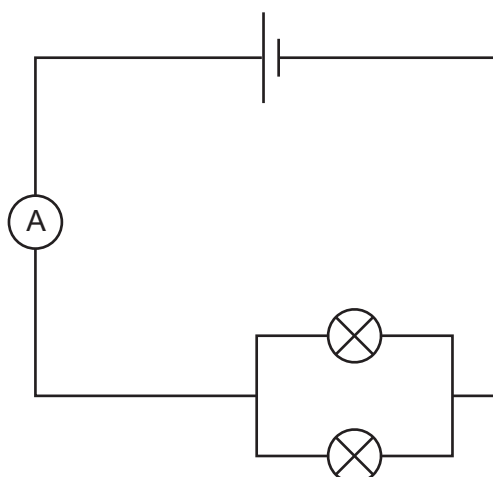

Fig. 9.2

(i) Describe how the circuit arrangement in Fig. 9.2 differs from that shown in Fig. 9.1.

.....
 [1]

(ii) Predict whether the reading on the ammeter in Fig. 9.2 will be greater or less than the ammeter reading in Fig. 9.1.

Give a reason for your answer.

.....
 [1]

[Total: 9]

BLANK PAGE

Permission to reproduce items where third-party owned material protected by copyright is included has been sought and cleared where possible. Every reasonable effort has been made by the publisher (UCLES) to trace copyright holders, but if any items requiring clearance have unwittingly been included, the publisher will be pleased to make amends at the earliest possible opportunity.

To avoid the issue of disclosure of answer-related information to candidates, all copyright acknowledgements are reproduced online in the Cambridge Assessment International Education Copyright Acknowledgements Booklet. This is produced for each series of examinations and is freely available to download at www.cambridgeinternational.org after the live examination series.

Cambridge Assessment International Education is part of Cambridge Assessment. Cambridge Assessment is the brand name of the University of Cambridge Local Examinations Syndicate (UCLES), which is a department of the University of Cambridge.

The Periodic Table of Elements

Group																																																																																		
I	II	III										IV	V	VI	VII	VIII																																																																		
3 Li lithium 7	4 Be beryllium 9	Key atomic number atomic symbol name relative atomic mass																2 He helium 4																																																																
11 Na sodium 23	12 Mg magnesium 24																	1 H hydrogen 1	5 B boron 11	6 C carbon 12	7 N nitrogen 14	8 O oxygen 16	9 F fluorine 19	10 Ne neon 20	13 Al aluminium 27	14 Si silicon 28	15 P phosphorus 31	16 S sulfur 32	17 Cl chlorine 35.5	18 Ar argon 40	19 K potassium 39	20 Ca calcium 40	21 Sc scandium 45	22 Ti titanium 48	23 V vanadium 51	24 Cr chromium 52	25 Mn manganese 55	26 Fe iron 56	27 Co cobalt 59	28 Ni nickel 59	29 Cu copper 64	30 Zn zinc 65	31 Ga gallium 70	32 Ge germanium 73	33 As arsenic 75	34 Se selenium 79	35 Br bromine 80	36 Kr krypton 84	37 Rb rubidium 85	38 Sr strontium 88	39 Y yttrium 89	40 Zr zirconium 91	41 Nb niobium 93	42 Mo molybdenum 96	43 Tc technetium —	44 Ru ruthenium 101	45 Rh rhodium 103	46 Pd palladium 106	47 Ag silver 108	48 Cd cadmium 112	49 In indium 115	50 Sn tin 119	51 Sb antimony 122	52 Te tellurium 128	53 I iodine 127	54 Xe xenon 131	55 Cs caesium 133	56 Ba barium 137	57–71 lanthanoids	58 Hf hafnium 178	59 Ta tantalum 181	60 W tungsten 184	61 Re rhenium 186	62 Os osmium 190	63 Ir iridium 192	64 Pt platinum 195	65 Au gold 197	66 Hg mercury 201	67 Tl thallium 204	68 Pb lead 207	69 Bi bismuth 209	70 Po polonium —

lanthanoids	57 La lanthanum 139	58 Ce cerium 140	59 Pr praseodymium 141	60 Nd neodymium 144	61 Pm promethium —	62 Sm samarium 150	63 Eu europium 152	64 Gd gadolinium 157	65 Tb terbium 159	66 Dy dysprosium 163	67 Ho holmium 165	68 Er erbium 167	69 Tm thulium 169	70 Yb ytterbium 173	71 Lu lutetium 175
actinoids	89 Ac actinium —	90 Th thorium 232	91 Pa protactinium 231	92 U uranium 238	93 Np neptunium —	94 Pu plutonium —	95 Am americium —	96 Cm curium —	97 Bk berkelium —	98 Cf californium —	99 Es einsteinium —	100 Fm fermium —	101 Md mendelevium —	102 No nobelium —	103 Lr lawrencium —

The volume of one mole of any gas is 24 dm³ at room temperature and pressure (r.t.p.).