



Cambridge IGCSE™

COMBINED SCIENCE

0653/22

Paper 2 Multiple Choice (Extended)

May/June 2020

45 minutes

You must answer on the multiple choice answer sheet.

You will need: Multiple choice answer sheet
Soft clean eraser
Soft pencil (type B or HB is recommended)

INSTRUCTIONS

- There are **forty** questions on this paper. Answer **all** questions.
- For each question there are four possible answers **A, B, C** and **D**. Choose the **one** you consider correct and record your choice in soft pencil on the multiple choice answer sheet.
- Follow the instructions on the multiple choice answer sheet.
- Write in soft pencil.
- Write your name, centre number and candidate number on the multiple choice answer sheet in the spaces provided unless this has been done for you.
- Do **not** use correction fluid.
- Do **not** write on any bar codes.
- You may use a calculator.

INFORMATION

- The total mark for this paper is 40.
- Each correct answer will score one mark. A mark will not be deducted for a wrong answer.
- Any rough working should be done on this question paper.
- The Periodic Table is printed in the question paper.

This document has **16** pages. Blank pages are indicated.



1 The diagram shows a palisade mesophyll cell from a leaf.

The features of the cell are numbered.

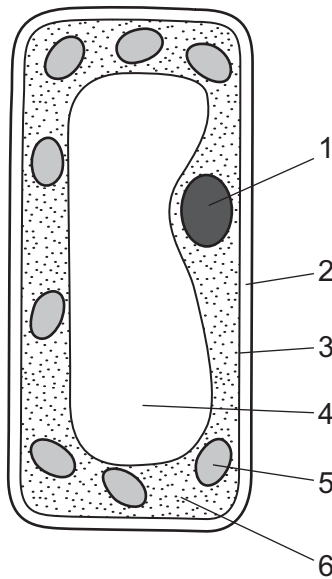

Which features are found only in plant cells?

- A** 1, 2 and 3 **B** 1, 5 and 6 **C** 2, 4 and 5 **D** 3, 4 and 6

2 Which row about osmosis is correct?

	molecules that move	details of movement	permeability of membrane
A	solute	from a concentrated solution to a dilute solution	fully
B	solute	from a dilute solution to a concentrated solution	partially
C	water	from a concentrated solution to a dilute solution	fully
D	water	from a dilute solution to a concentrated solution	partially

3 Which row matches the adaptation of a root hair cell to its function?

	adaptation	function
A	large surface area	uptake of water and glucose
B	large surface area	uptake of water and ions
C	small surface area	uptake of water and glucose
D	small surface area	uptake of water and ions

- 4 The graph shows the activity of an enzyme as temperature increases.

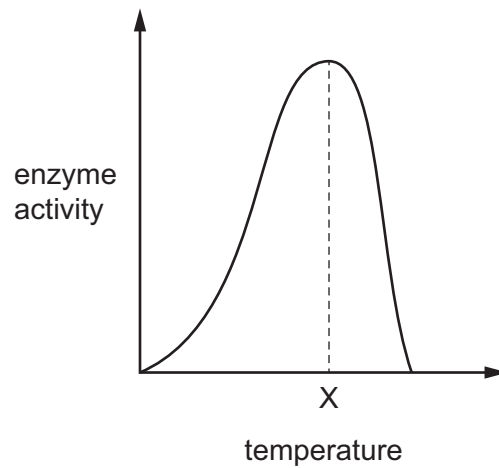

What happens to the enzyme as the temperature increases above X?

- A The enzyme becomes too hot and dies.
 - B The enzyme denatures.
 - C The enzyme is used up.
 - D The enzyme activity increases.
- 5 What are the correct substrate and products for lipase?

	substrate	products
A	fat	amino acids
B	fat	fatty acids and glycerol
C	protein	amino acids
D	protein	fatty acids and glycerol

- 6 How does auxin cause a plant shoot to bend to the right?
- A Cells elongate more on the left side of the shoot than on the right side.
 - B Cells elongate more on the right side of the shoot than on the left side.
 - C Cells shrink on the left side of the shoot.
 - D Cells shrink on the right side of the shoot.

- 7 Which component of tobacco smoke reduces the ability of haemoglobin to carry oxygen?
- A carbon monoxide
 - B nicotine
 - C smoke particles
 - D tar
- 8 Which substances are the products of photosynthesis?
- A carbon dioxide and glucose
 - B glucose and oxygen
 - C oxygen and water
 - D water and carbon dioxide
- 9 Four people have the same resting pulse rate and the same blood glucose concentration. The table shows their pulse rates and blood glucose concentrations later on the same day.

Which person has the highest concentration of adrenaline in their blood?

	pulse rate / beats per minute	blood glucose concentration /mg per dm ³
A	70	65
B	70	100
C	120	65
D	120	100

10 The diagram shows the root of a plant exposed to light and gravity, and the same root a day later.

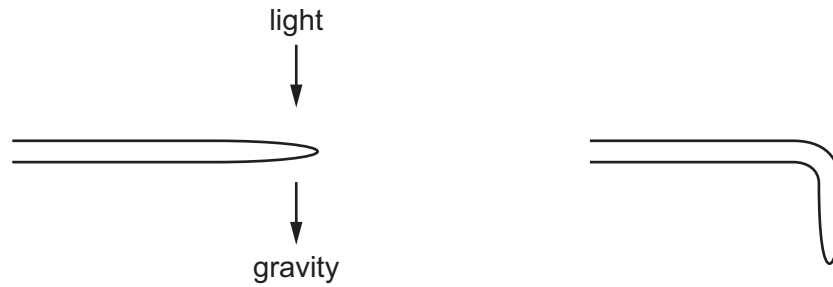

Light does **not** influence the growth of roots in this plant.

Which row shows how the root has responded?

	gravitropism	phototropism
A	grows away from the stimulus	no response
B	grows towards the stimulus	no response
C	no response	grows away from the stimulus
D	no response	grows towards the stimulus

11 Which diagram of a flower is correctly labelled?

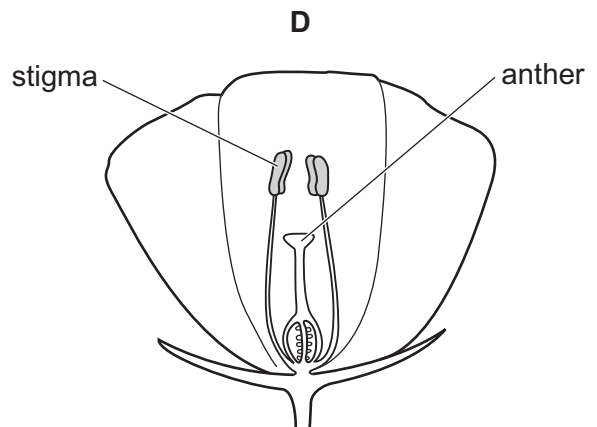
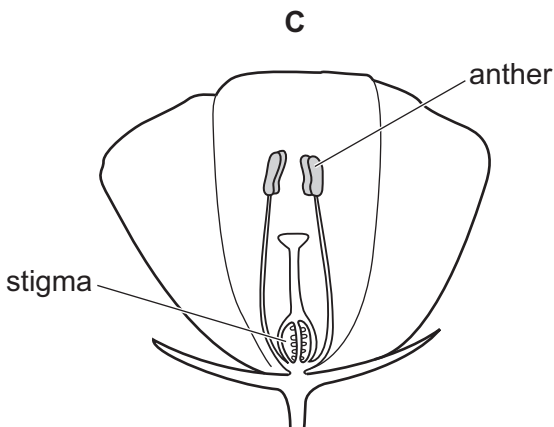
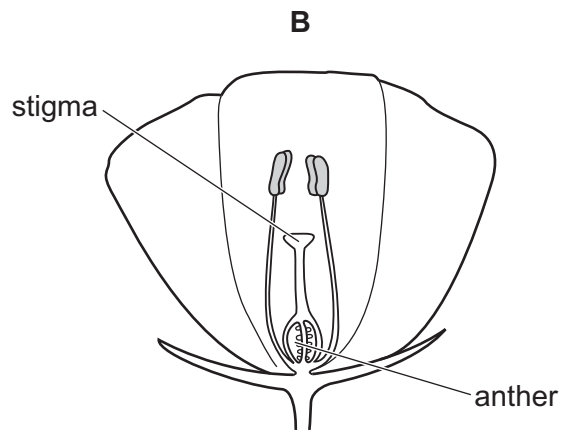
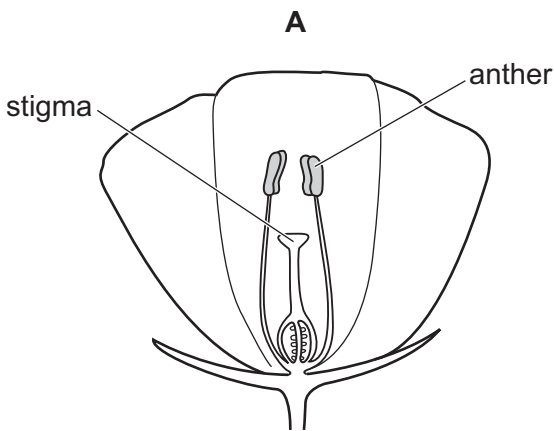

12 Which row contains correct adaptive features for both sperm and egg cells?

	sperm	egg
A	energy store	presence of enzymes
B	flagellum	jelly coat
C	jelly coat	energy store
D	presence of enzymes	flagellum

13 Which stage of eutrophication must be reached to cause fish to die?

- A** increased growth of decomposers
- B** increased levels of nitrates
- C** increased growth of plants
- D** reduction of dissolved oxygen

14 Which process uses R_f values to identify the components of a mixture?

- A** chromatography
- B** crystallisation
- C** distillation
- D** filtration

15 In which experiment is a compound formed?

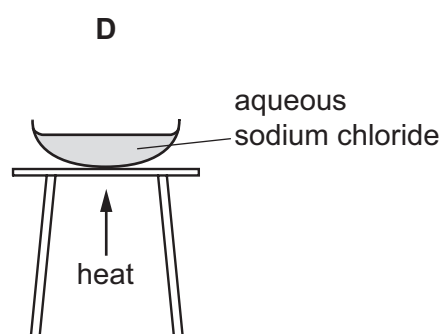
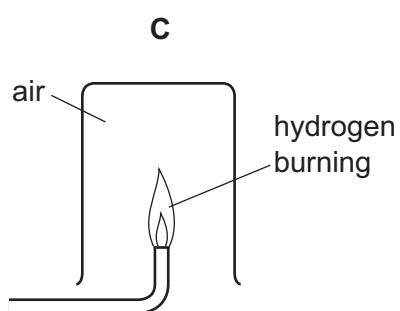
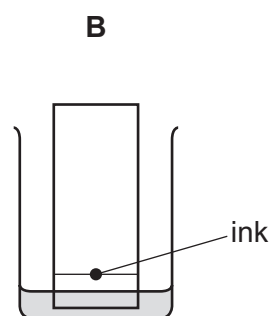
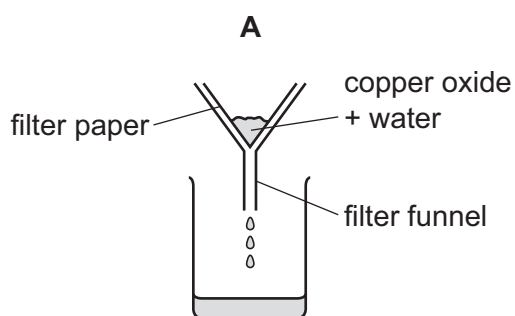

16 A magnesium ion, Mg^{2+} , is formed from a magnesium atom, Mg.

Which row about the numbers of protons and neutrons in the magnesium ion and in the magnesium atom is correct?

	number of protons	number of neutrons
A	larger in Mg^{2+} than in Mg	same in Mg and Mg^{2+}
B	same in Mg and Mg^{2+}	same in Mg and Mg^{2+}
C	same in Mg and Mg^{2+}	smaller in Mg^{2+} than in Mg
D	smaller in Mg^{2+} than in Mg	larger in Mg^{2+} than in Mg

17 Aluminium displaces copper from an aqueous solution of its ions.

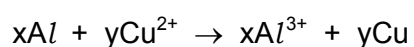

Which values of x and y balance the equation?

	x	y
A	1	2
B	2	1
C	2	3
D	3	2

18 Solid sodium carbonate is added to vinegar in a beaker and stirred.

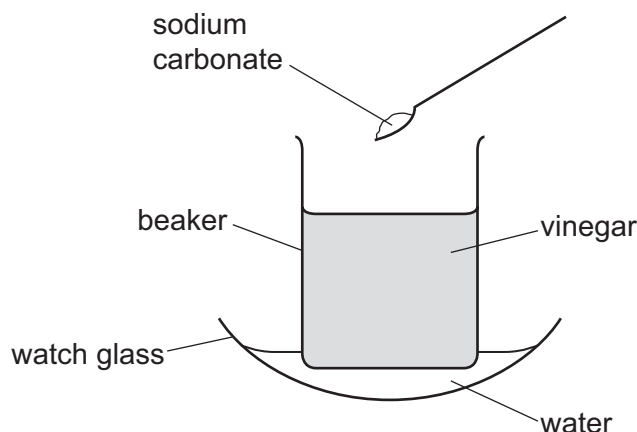

The water in the watch glass freezes.

Which statement about the reaction explains why the water freezes?

- A It is a redox reaction.
- B It is an endothermic reaction.
- C It is catalysed by sodium carbonate.
- D It is thermal decomposition.

19 Which statements about redox reactions are correct?

- 1 The oxidising agent oxidises another substance.
- 2 The reducing agent is oxidised.
- 3 The substance that loses oxygen has been oxidised.

- A 1 and 2 only B 1 and 3 only C 2 and 3 only D 1, 2 and 3

20 Copper(II) sulfate is prepared by reacting copper(II) oxide with dilute sulfuric acid.

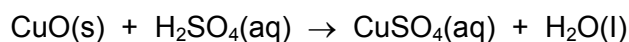

Which statement is correct?

- A Excess copper(II) oxide is used because it can be easily removed by filtration.
- B Excess copper(II) oxide is used because it can be easily removed by reacting with more sulfuric acid.
- C Excess sulfuric acid is used because it can be easily removed by evaporation.
- D Excess sulfuric acid is used because unreacted copper(II) oxide would contaminate the product.

21 Solution X is mixed with nitric acid and aqueous barium nitrate.

A white precipitate is formed.

Which ion is present in solution X?

- A carbonate
- B chloride
- C nitrate
- D sulfate

22 Which row shows the relationship between the group number of an element, its number of outer shell electrons and its metallic / non-metallic character?

	group number	number of outer shell electrons	metallic / non-metallic character
A	I	1	non-metal
B	III	5	metal
C	V	5	non-metal
D	VII	1	metal

23 Astatine is an element found at the bottom of Group VII in the Periodic Table.

Which row shows the properties of astatine?

	melting point / °C	reacts with iodide ions
A	-7	no
B	302	no
C	-7	yes
D	302	yes

24 Atoms and ions of metals P, Q and R take part in two reactions.

The equations for these reactions are shown.

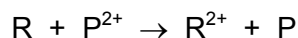
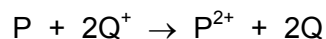

Which statements are correct?

- 1 P is more reactive than R.
- 2 P is less reactive than Q.
- 3 R is more reactive than Q.
- 4 R loses electrons most readily.

A 1 and 2 **B** 1 and 3 **C** 2 and 4 **D** 3 and 4

25 Copper can be made from copper oxide by reacting it with carbon at a high temperature.

Why is carbon used?

- A** It does not react with copper.
- B** It is a conductor of electricity.
- C** It is a high melting point solid.
- D** It is more reactive than copper.

26 Which row about a gas in clean air is correct?

	name of gas	percentage of gas
A	nitrogen	20
B	nitrogen	50
C	oxygen	20
D	oxygen	50

27 In which list are all of the hydrocarbons in the same homologous series?

- A** CH₄, C₂H₆, C₃H₈, C₅H₁₀
- B** C₂H₄, C₂H₆, C₃H₆, C₄H₈
- C** C₂H₄, C₃H₆, C₄H₈, C₅H₁₀
- D** C₂H₆, C₃H₆, C₄H₈, C₅H₁₀

28 Which distance–time graph represents a body that is moving with changing speed?

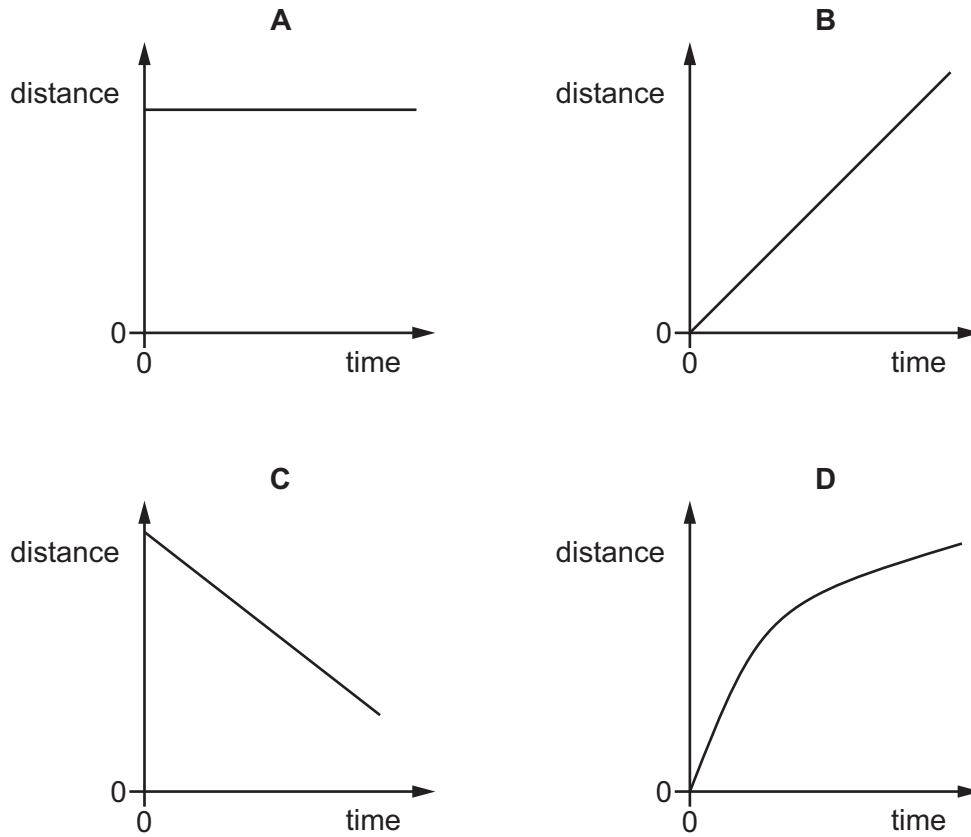

29 A car travels at various speeds during a short journey.

The table shows the distances travelled and the times taken during each of four stages P, Q, R and S.

stage	P	Q	R	S
distance travelled / km	1.8	3.6	2.7	2.7
time taken / minutes	2.0	2.0	4.0	3.0

During which two stages is the car travelling at the same average speed?

- A** P and Q **B** P and S **C** Q and R **D** R and S

- 30 A spring obeys Hooke's law. A load of 10 N hangs from the spring and causes the spring to extend by 12 mm.

Two springs, identical to the first one, are now joined as shown. A load of 5.0 N is hung from the springs.

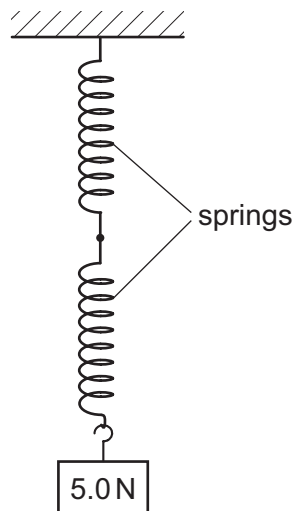

What is the total extension of the combination of the two springs?

- A 3.0 mm B 6.0 mm C 12 mm D 24 mm
- 31 A force F acts on a body of mass m for a time t . In this time, the speed of the body increases from speed u to speed v and the body travels a distance d .

Which expression gives the work done by the force on the body?

- A $F \times d$ B $F \times t$ C $F \times u$ D $F \times v$
- 32 Four objects P, Q, R and S are moving.

The table shows the mass and speed of each object.

	mass/kg	$\frac{\text{speed}}{\text{m/s}}$
P	1.0	4.0
Q	2.0	1.0
R	1.0	2.0
S	4.0	1.0

Which two objects have equal kinetic energy?

- A P and R B P and S C Q and R D R and S

33 Which action increases the rate of evaporation of a liquid?

- A cooling the liquid
- B covering the liquid
- C increasing the surface area of the liquid
- D reducing any draught over the liquid

34 Conduction of heat in metals involves the movement of atoms and electrons.

Which row describes the movement of the atoms and the electrons?

	atoms	electrons
A	move freely	move freely
B	move freely	vibrate about fixed positions
C	vibrate about fixed positions	move freely
D	vibrate about fixed positions	vibrate about fixed positions

35 Four students suggest values for the speed of electromagnetic waves in a vacuum.

The students use two different units.

Which value is correct?

- A 300 m/s
- B 300 km/s
- C 3.0×10^5 m/s
- D 3.0×10^5 km/s

36 The sound from a drum is loud and has a low pitch.

Which row describes the amplitude and the frequency of the sound wave?

	amplitude	frequency
A	large	high
B	large	low
C	small	high
D	small	low

37 What is the unit of charge?

- A ampere
- B coulomb
- C ohm
- D volt

38 An electric circuit contains two resistors connected to a cell.

One resistor is labelled R. The switch is open.

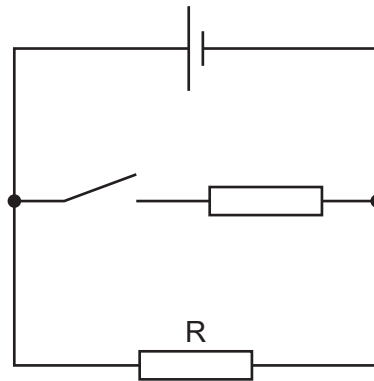

The switch is now closed.

What happens to the potential difference (p.d.) across resistor R and what happens to the current in resistor R?

- A The p.d. decreases and the current increases.
 - B The p.d. decreases and the current remains the same.
 - C The p.d. remains the same and the current increases.
 - D The p.d. remains the same and the current remains the same.
- 39 A 12 V power supply is connected to a $6.0\ \Omega$ resistor. This causes a current in the resistor.

How much thermal energy is produced in the resistor in 5.0 minutes?

- A 120 J
- B 600 J
- C 7200 J
- D 21 600 J

- 40** The charger for a laptop computer is connected by a cable to the mains supply through a plug. The plug contains a 13 A fuse. The cable is designed to carry a current of 2 A. A fault develops and the current in the cable increases to 5 A.

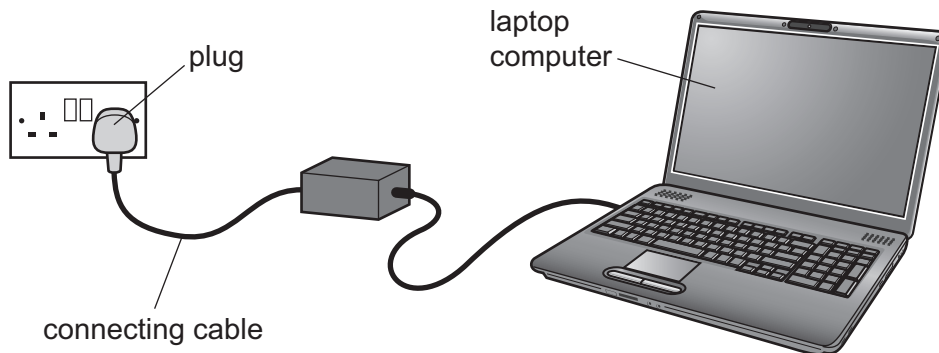

What is a possible danger caused by this larger current?

- A** A large amount of electrical energy is wasted.
- B** Somebody receives an electric shock.
- C** The fuse blows and starts a fire.
- D** The cable overheats and starts a fire.

Permission to reproduce items where third-party owned material protected by copyright is included has been sought and cleared where possible. Every reasonable effort has been made by the publisher (UCLES) to trace copyright holders, but if any items requiring clearance have unwittingly been included, the publisher will be pleased to make amends at the earliest possible opportunity.

To avoid the issue of disclosure of answer-related information to candidates, all copyright acknowledgements are reproduced online in the Cambridge Assessment International Education Copyright Acknowledgements Booklet. This is produced for each series of examinations and is freely available to download at www.cambridgeinternational.org after the live examination series.

Cambridge Assessment International Education is part of the Cambridge Assessment Group. Cambridge Assessment is the brand name of the University of Cambridge Local Examinations Syndicate (UCLES), which itself is a department of the University of Cambridge.

The Periodic Table of Elements

		Group															
I	II	III	IV	V	VI	VII	VIII										
3 Li lithium 7	4 Be beryllium 9	<div style="border: 1px solid black; padding: 5px; width: fit-content; margin: 0 auto;"> Key atomic number atomic symbol name relative atomic mass </div>										2 He helium 4					
11 Na sodium 23	12 Mg magnesium 24											5 B boron 11	6 C carbon 12	7 N nitrogen 14	8 O oxygen 16	9 F fluorine 19	10 Ne neon 20
19 K potassium 39	20 Ca calcium 40	21 Sc scandium 45	22 Ti titanium 48	23 V vanadium 51	24 Cr chromium 52	25 Mn manganese 55	26 Fe iron 56	27 Co cobalt 59	28 Ni nickel 59	29 Cu copper 64	30 Zn zinc 65	31 Ga gallium 70	32 Ge germanium 73	33 As arsenic 75	34 Se selenium 79	35 Br bromine 80	36 Kr krypton 84
37 Rb rubidium 85	38 Sr strontium 88	39 Y yttrium 89	40 Zr zirconium 91	41 Nb niobium 93	42 Mo molybdenum 96	43 Tc technetium —	44 Ru ruthenium 101	45 Rh rhodium 103	46 Pd palladium 106	47 Ag silver 108	48 Cd cadmium 112	49 In indium 115	50 Sn tin 119	51 Sb antimony 122	52 Te tellurium 128	53 I iodine 127	54 Xe xenon 131
55 Cs caesium 133	56 Ba barium 137	57–71 lanthanoids	72 Hf hafnium 178	73 Ta tantalum 181	74 W tungsten 184	75 Re rhenium 186	76 Os osmium 190	77 Ir iridium 192	78 Pt platinum 195	79 Au gold 197	80 Hg mercury 201	81 Tl thallium 204	82 Pb lead 207	83 Bi bismuth 209	84 Po polonium —	85 At astatine —	86 Rn radon —
87 Fr francium —	88 Ra radium —	89–103 actinoids	104 Rf rutherfordium —	105 Db dubnium —	106 Sg seaborgium —	107 Bh bohrium —	108 Hs hassium —	109 Mt meitnerium —	110 Ds darmstadtium —	111 Rg roentgenium —	112 Cn copernicium —	114 F1 flerovium —	116 Lv livermorium —	—	—	—	—

lanthanoids	57 La lanthanum 139	58 Ce cerium 140	59 Pr praseodymium 141	60 Nd neodymium 144	61 Pm promethium —	62 Sm samarium 150	63 Eu europium 152	64 Gd gadolinium 157	65 Tb terbium 159	66 Dy dysprosium 163	67 Ho holmium 165	68 Er erbium 167	69 Tm thulium 169	70 Yb ytterbium 173	71 Lu lutetium 175
actinoids	89 Ac actinium —	90 Th thorium 232	91 Pa protactinium 231	92 U uranium 238	93 Np neptunium —	94 Pu plutonium —	95 Am americium —	96 Cm curium —	97 Bk berkelium —	98 Cf californium —	99 Es einsteinium —	100 Fm fermium —	101 Md mendelevium —	102 No nobelium —	103 Lr lawrencium —

The volume of one mole of any gas is 24 dm³ at room temperature and pressure (r.t.p.).