



**Cambridge Assessment International Education**  
Cambridge International General Certificate of Secondary Education

**PHYSICS**

**0625/13**

Paper 1 Multiple Choice (Core)

**May/June 2019**

**45 minutes**

Additional Materials: Multiple Choice Answer Sheet  
Soft clean eraser  
Soft pencil (type B or HB recommended)

\* 2 5 7 5 9 3 4 7 9 1 \*

**READ THESE INSTRUCTIONS FIRST**

Write in soft pencil.

Do not use staples, paper clips, glue or correction fluid.

Write your name, centre number and candidate number on the Answer Sheet in the spaces provided unless this has been done for you.

**DO NOT WRITE IN ANY BARCODES.**

There are **forty** questions on this paper. Answer **all** questions. For each question there are four possible answers **A, B, C** and **D**.

Choose the **one** you consider correct and record your choice in **soft pencil** on the separate Answer Sheet.

**Read the instructions on the Answer Sheet very carefully.**

Each correct answer will score one mark. A mark will not be deducted for a wrong answer.

Any rough working should be done in this booklet.

Electronic calculators may be used.

Take the weight of 1.0 kg to be 10 N (acceleration of free fall =  $10 \text{ m/s}^2$ ).

bestexamhelp.com

This syllabus is regulated for use in England, Wales and Northern Ireland as a Cambridge International Level 1/Level 2 Certificate.

This document consists of **20** printed pages.

- 1 The diagram shows a measuring cylinder containing liquid.

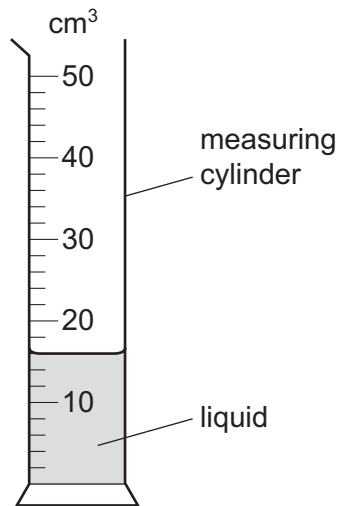

What is the reading for the volume of liquid in the cylinder?

- A** 13.0 cm<sup>3</sup>      **B** 13.5 cm<sup>3</sup>      **C** 16.0 cm<sup>3</sup>      **D** 17.0 cm<sup>3</sup>
- 2 The diagram shows the speed-time graph for a car.

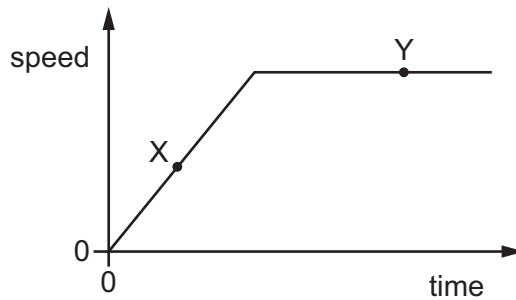

Which row describes the motion of the car at point X and at point Y?

	point X	point Y
<b>A</b>	at rest	moving with constant speed
<b>B</b>	moving with constant speed	at rest
<b>C</b>	moving with changing speed	at rest
<b>D</b>	moving with changing speed	moving with constant speed

- 3 A heavy metal ball falls vertically downwards through air past four equally spaced levels J, K, L and M.

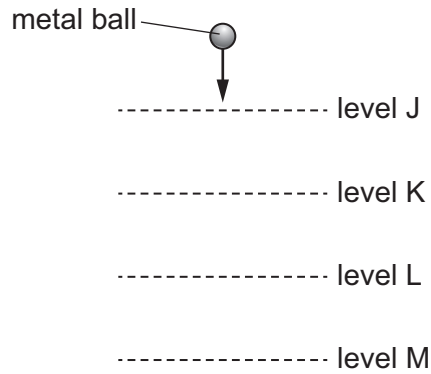

The times taken to fall from one level to the next are measured.

Where is the speed of the ball greatest and which time is shortest?

	speed is greatest between	time is shortest between
<b>A</b>	J and K	J and K
<b>B</b>	J and K	L and M
<b>C</b>	L and M	J and K
<b>D</b>	L and M	L and M

- 4 An object which has a mass of 600 kg is on the planet Mars.

The acceleration due to gravity on Mars is  $4.0 \text{ m/s}^2$ .

What is the weight of the object on Mars?

- A** 60 N      **B** 150 N      **C** 2400 N      **D** 6000 N

- 5 Two objects are placed on a balance, one on each side:

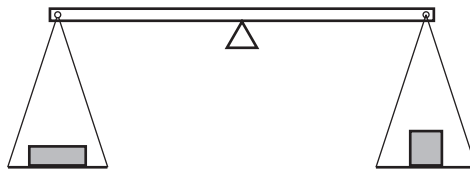

Which properties of the objects can be compared using the balance?

- A** weight, mass and volume  
**B** weight and mass only  
**C** volume and density  
**D** density only

6 X, Y and Z are three regularly shaped solid objects.

Their dimensions and masses are shown in the diagrams.

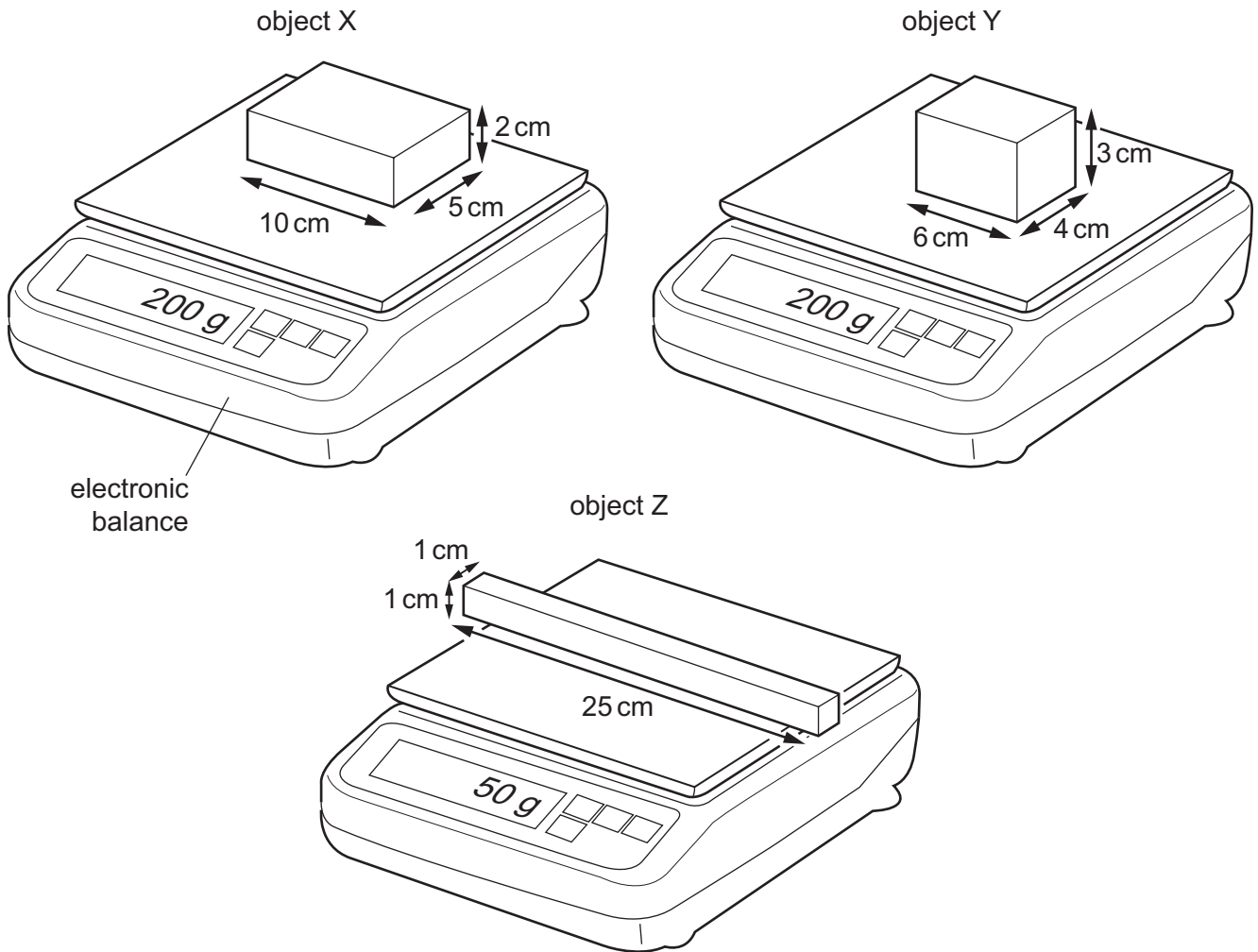

Which objects have the same density?

- A** X, Y and Z    **B** X and Y only    **C** X and Z only    **D** Y and Z only

7 A car is driven from rest on a long straight road. The car engine exerts a constant driving force.

The diagram shows the horizontal forces acting on the car. The resistive forces are proportional to the speed of the car.

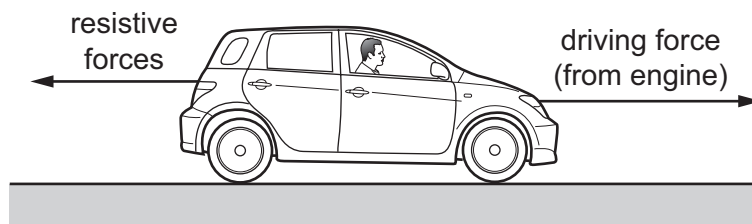

Why does the car eventually reach a maximum speed?

- A The resistive forces decrease to make the acceleration of the car negative.
- B The resistive forces decrease to make the acceleration of the car zero.
- C The resistive forces increase to make the acceleration of the car negative.
- D The resistive forces increase to make the acceleration of the car zero.

- 8 A spring is suspended from a stand. Loads are added and the extensions are measured.

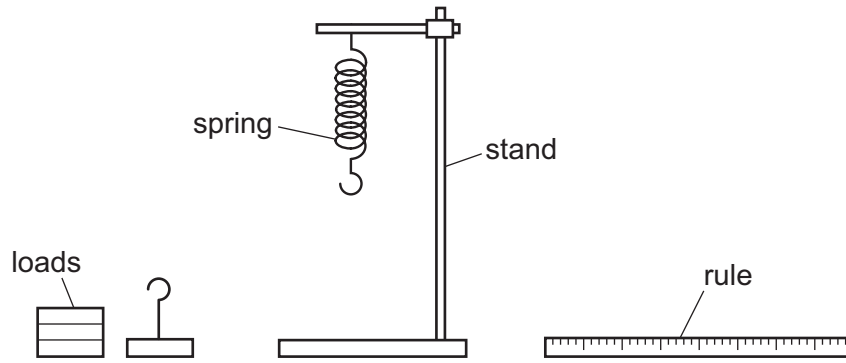

Which graph shows the result of plotting extension against load?

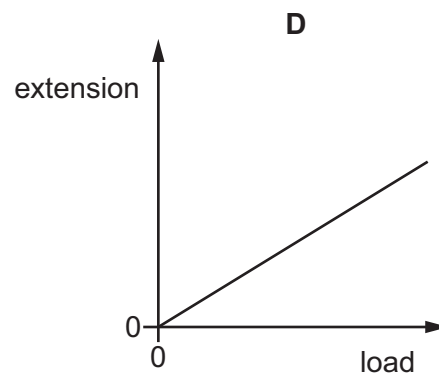
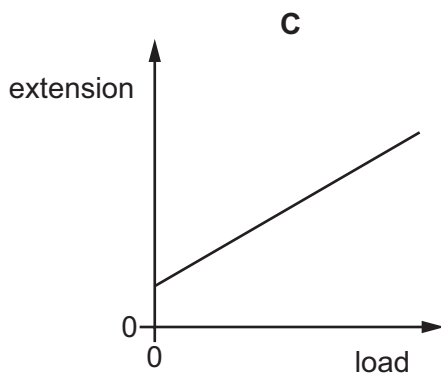
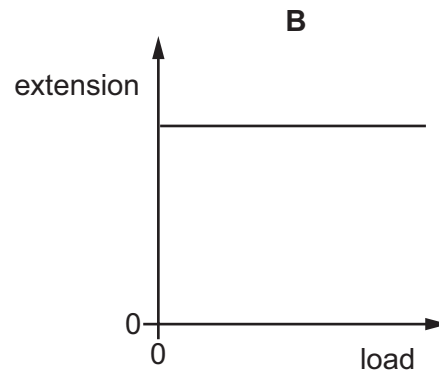
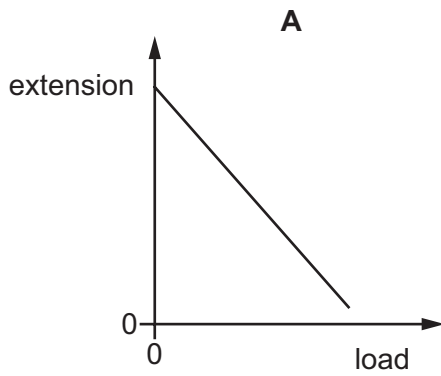

- 9 A wooden bar is pivoted at its centre so that it can rotate freely. Two equal forces  $F$  are applied to the bar.

In which diagram is the turning effect greatest?

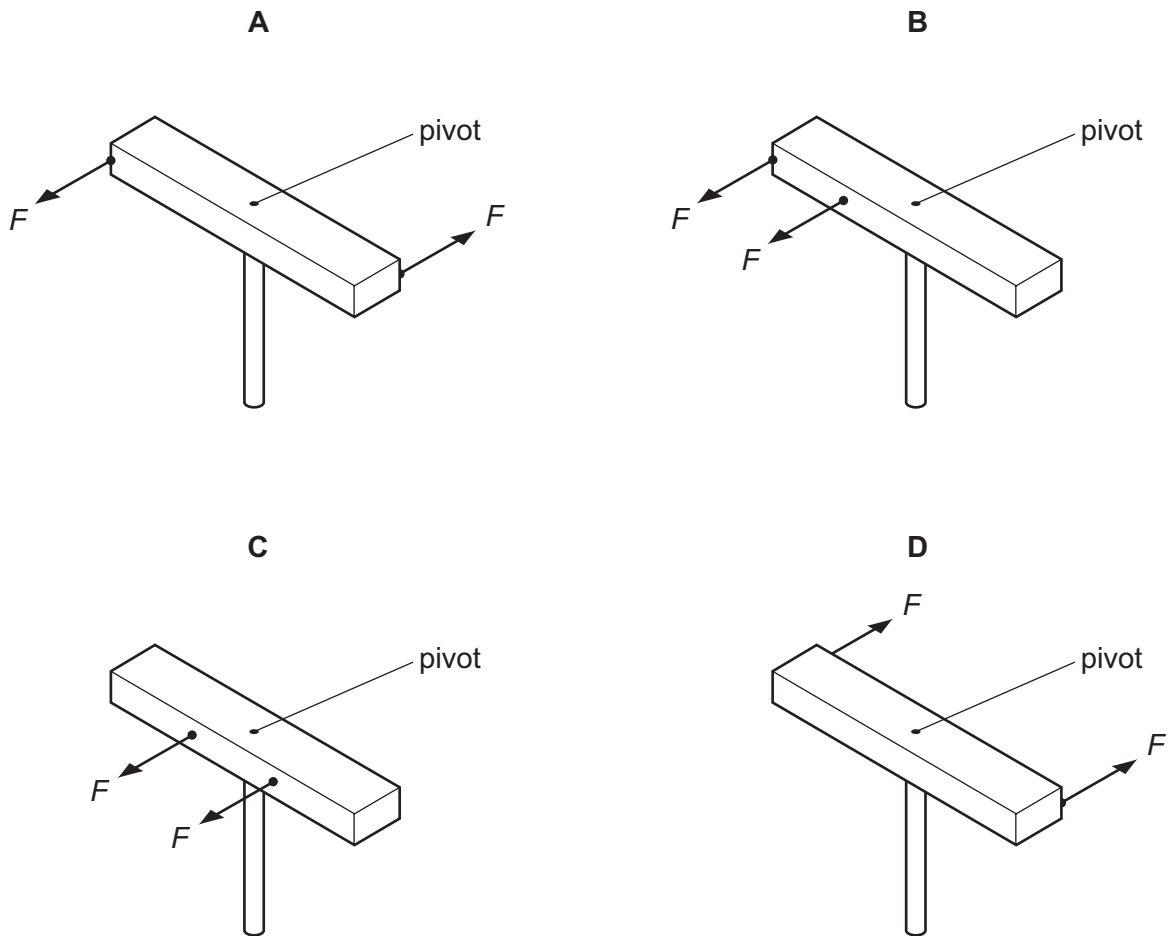

- 10 A machine is very efficient.

What does this mean?

- A It produces a large amount of power.
  - B It uses very little energy.
  - C It wastes very little energy.
  - D It works very quickly.
- 11 A body is lifted against gravity.
- Which equation shows the work done on the body?
- A work done = change in distance moved by the body
  - B work done = change in energy of the body
  - C work done = change in force on the body
  - D work done = change in power of the body

12 The diagram shows a simple mercury barometer.

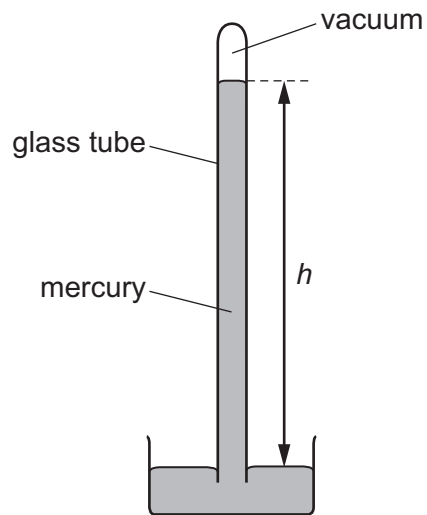

A change is made and the vertical height  $h$  of the column increases.

Which change causes this increase?

- A A liquid with a lower density than mercury has been used.
  - B Atmospheric pressure decreases.
  - C A narrower glass tube is used.
  - D The glass tube is tilted.
- 13 The diagram shows a stone suspended on a string under the surface of a liquid. The stone experiences a pressure caused by the liquid.

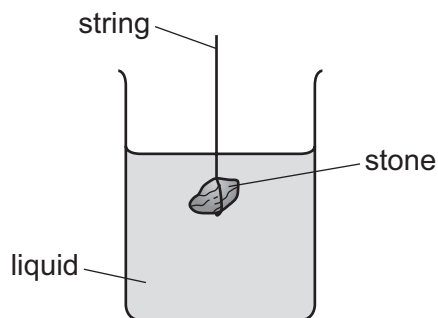

What would increase the pressure on the stone?

- A decreasing the surface area of the stone
- B increasing the mass of the stone
- C lowering the stone deeper into the liquid
- D using a liquid with a lower density



14 Which statement is correct?

- A A solid can flow.
- B A solid can be compressed easily.
- C A solid has a fixed shape.
- D A solid takes the shape of its container.

15 On a hot summer day, the level of the water in a pond falls.

Which statement explains this?

- A The least energetic water molecules escape from the surface and do not return.
- B The least energetic water molecules escape from the surface and then return.
- C The most energetic water molecules escape from the surface and do not return.
- D The most energetic water molecules escape from the surface and then return.

16 Here are three statements about a liquid-in-glass thermometer with a Celsius scale.

- 1 The lower fixed point is the temperature at which pure water freezes.
- 2 The upper fixed point is the temperature at which pure water boils.
- 3 A scale is made by dividing the distance between the fixed points into equal divisions.

Which statements are correct?

- A 1 and 2 only    B 2 and 3 only    C 1 and 3 only    D 1, 2 and 3

- 17 A night storage heater contains a large block of material that is heated electrically during the night. During the day the block cools down, releasing thermal energy into the room.

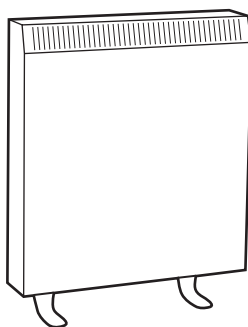

Which thermal capacity and which night-time temperature increase will cause the most energy to be stored by the block?

	thermal capacity of block	night-time temperature increase
<b>A</b>	large	large
<b>B</b>	large	small
<b>C</b>	small	large
<b>D</b>	small	small

- 18 A student investigates the melting point of a pure substance. She heats the substance slowly and takes readings of its temperature as the substance starts to melt and when it finishes melting.

Which statement is correct?

- A** The temperature decreases slightly as the substance melts.
- B** The temperature fluctuates as the substance melts.
- C** The temperature increases as the substance melts.
- D** The temperature stays the same as the substance melts.
- 19 A person holds an empty glass beaker and pours hot water into it.
- Why does it take a few seconds before his hand starts to feel hot?
- A** Glass is a poor conductor of heat.
- B** Water is a poor conductor of heat.
- C** Glass is a better conductor of heat than water.
- D** Water is a better conductor of heat than glass.

20 The metal surface of a kettle is hot.

What happens to the cool air outside the kettle when it comes into contact with the hot kettle?

- A The density of the air decreases and the air falls.
- B The density of the air decreases and the air rises.
- C The density of the air increases and the air falls.
- D The density of the air increases and the air rises.

21 A student draws a diagram to show two different properties of a water wave. The arrows show the wave directions.

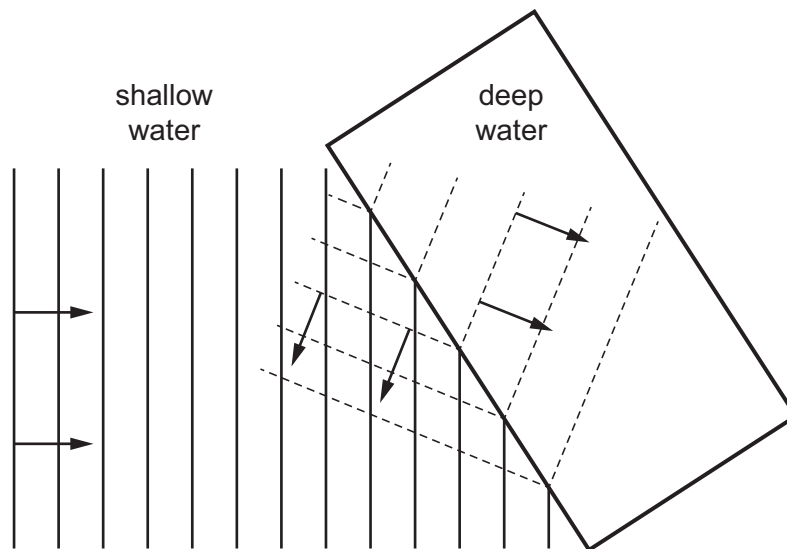

Which two wave properties does the diagram show?

- A refraction and diffraction
- B reflection and dispersion
- C reflection and diffraction
- D reflection and refraction

22 The diagram shows a cork with a weight attached so that the cork floats upright in water.

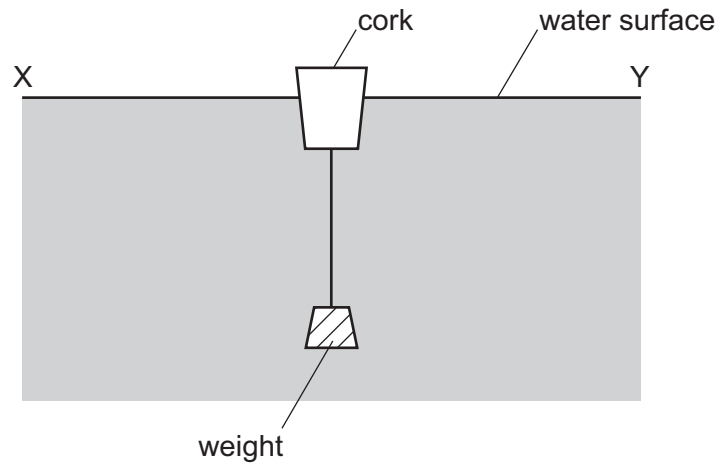

Transverse waves travel across the water from X to Y.

In which direction do the waves make the cork move?

- A → ← right and left
- B ↑ ↓ up and down
- C → only to the right
- D ← only to the left

23 A student draws a ray diagram to show how a ray of light is reflected by a number of mirrors.

Which reflection has **not** been drawn correctly?

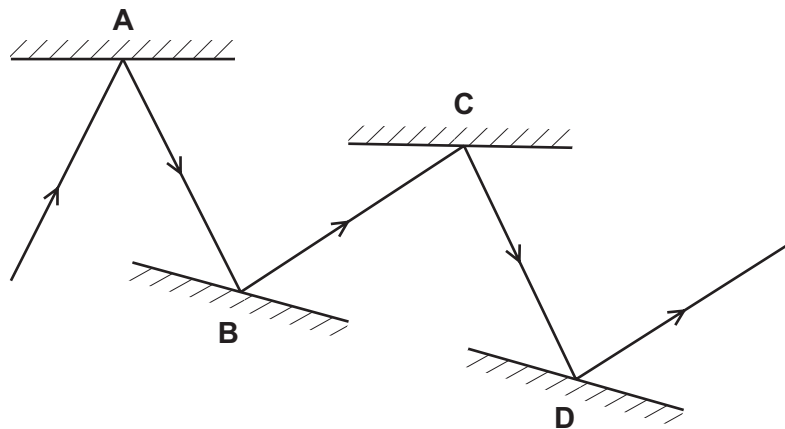

24 Light passes through a glass block.

What is the path of the light?

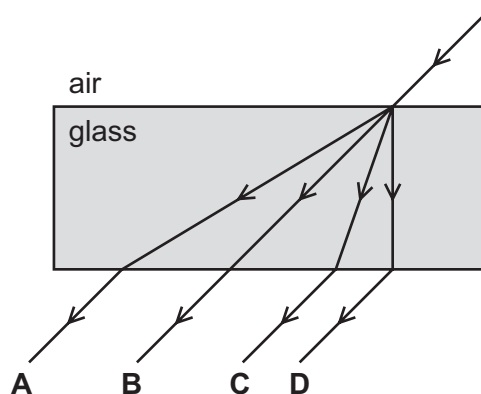

25 The diagram shows radiation from a lamp passing through a prism.

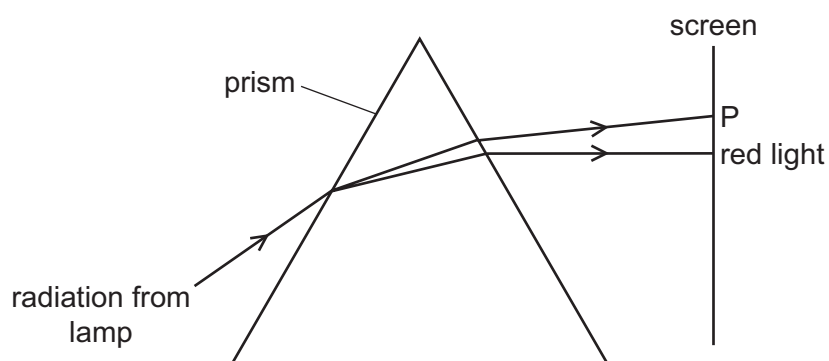

Which type of radiation is found at P?

- A  $\gamma$ -rays
- B infrared
- C ultraviolet
- D X-rays

26 A pulse of sound is produced at the bottom of a boat. The sound travels through the water and is reflected from a shoal of fish. The sound reaches the boat again after 1.2 s. The speed of sound in the water is 1500 m/s.

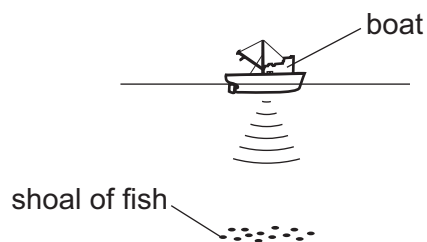

How far below the bottom of the boat is the shoal of fish?

- A 450 m
- B 900 m
- C 1800 m
- D 3600 m

27 Which statement about ultrasound is correct?

- A It has a higher frequency than audible sound, and it is a longitudinal wave.
- B It has a higher frequency than audible sound, and it is a transverse wave.
- C It has a lower frequency than audible sound, and it is a longitudinal wave.
- D It has a lower frequency than audible sound, and it is a transverse wave.

28 A metal bar is placed inside a current-carrying coil, as shown in diagram 1.

There is a small current in the coil. The bar holds a few nails, as shown in diagram 2.

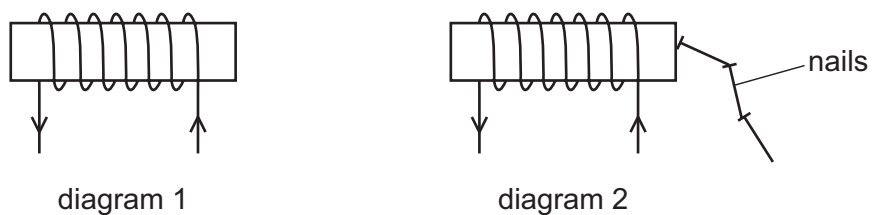

When there is no current in the coil, the nails drop off.

Which row is correct?

	metal from which the bar is made	effect of a larger current in the coil
<b>A</b>	soft iron	it makes no difference
<b>B</b>	soft iron	the bar holds more nails
<b>C</b>	steel	it makes no difference
<b>D</b>	steel	the bar holds more nails

- 29 An iron ball on a horizontal wooden table rolls near the north pole of a bar magnet which is lying on the table.

Which diagram shows the most likely path of the ball, as seen from above the table?

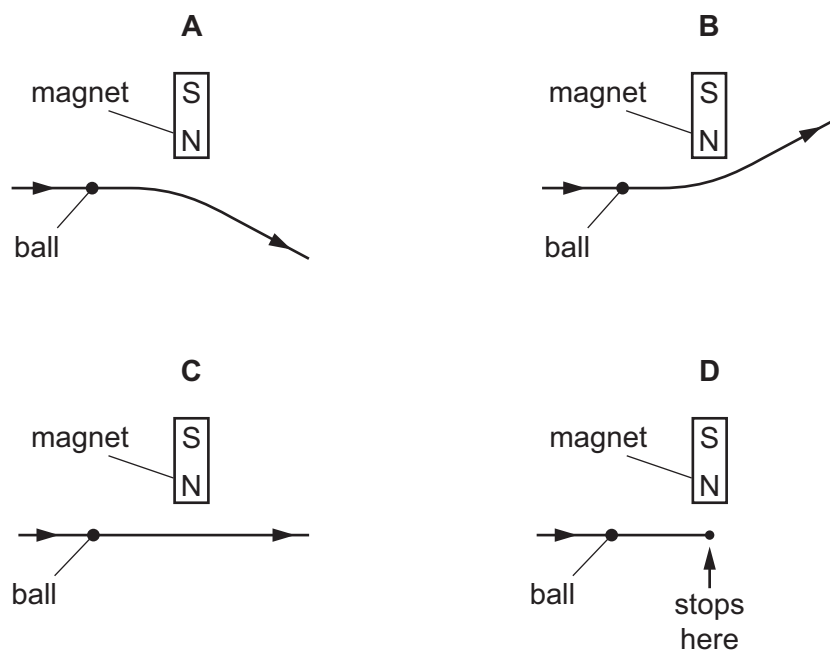

- 30 Diagram 1 shows two thin, uncharged strips of plastic.

Diagram 2 shows the same strips after they have been rubbed with a dry cloth.

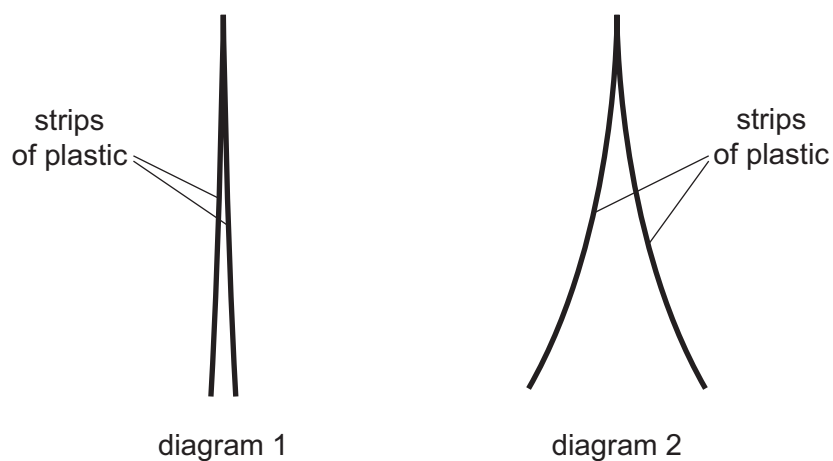

Which row describes the charge on the strips after rubbing, and the force between the strips after rubbing?

	charge on strips	force between strips
<b>A</b>	opposite	attraction
<b>B</b>	opposite	repulsion
<b>C</b>	the same	attraction
<b>D</b>	the same	repulsion

31 A battery stores chemical potential energy. The battery is connected to a resistor.

As the battery runs down, what happens to its chemical energy?

	The energy is transferred by	and ends up as
<b>A</b>	electrical working	internal energy in the resistor
<b>B</b>	electrical working	potential energy in the resistor
<b>C</b>	mechanical working	internal energy in the resistor
<b>D</b>	mechanical working	potential energy in the resistor

32 The diagram shows a circuit including a lamp, an electric bell and three switches  $S_1$ ,  $S_2$  and  $S_3$ .

The lamp and bell are not faulty.

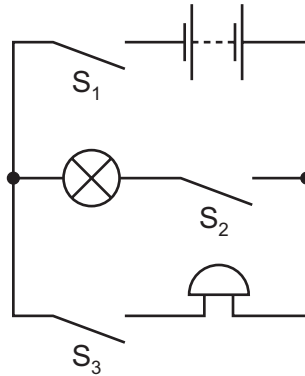

The bell is ringing but the lamp is not lit.

Which switches are closed?

- A**  $S_1$  only
- B**  $S_1$  and  $S_2$  only
- C**  $S_1$  and  $S_3$  only
- D**  $S_1$ ,  $S_2$  and  $S_3$



33 A student is designing a lighting circuit for a dolls' house. He sets up two different circuits.

Each circuit contains a 12 V power supply and three identical lamps.

Each lamp is designed to operate at normal brightness when connected individually to a 12 V supply.

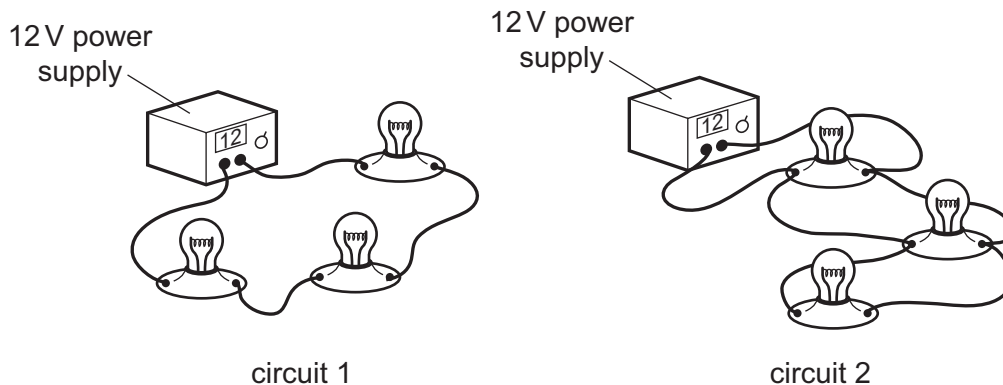

Which statement is correct?

- A** In circuit 1, each of the lamps is at normal brightness.
- B** In circuit 1, if one lamp fails, the other lamps remain lit.
- C** In circuit 2, if one lamp fails, the other lamps remain lit.
- D** In circuit 2, the current from the power supply is less than in circuit 1.

34 A lamp is to be connected in a circuit so that the potential difference (p.d.) across it can be varied from 0 to 6 V.

Which circuit would be most suitable?

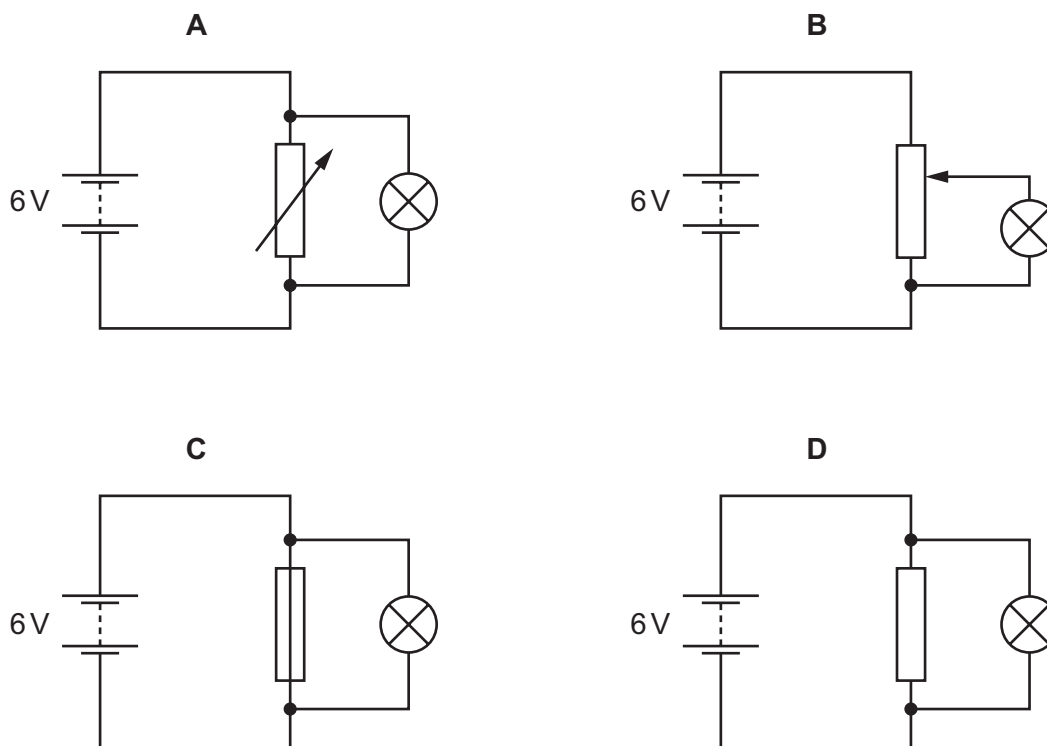

35 A simple wiring diagram for an electric cooker is shown.

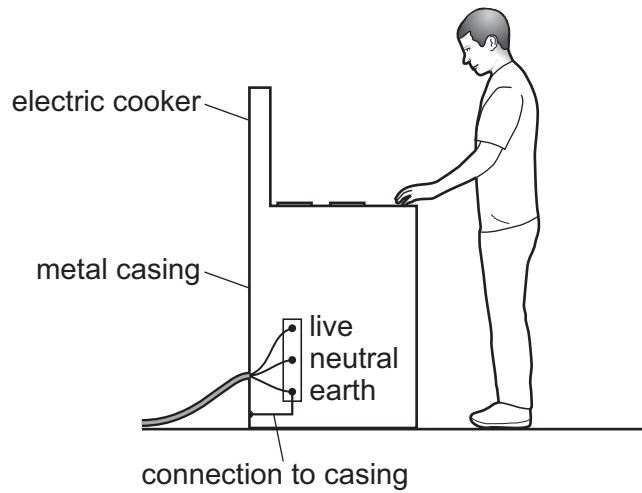

Why is there a wire connecting the metal case of the cooker to earth?

- A It improves the efficiency of the cooker.
- B It prevents the metal case from becoming too hot when the cooker is left on.
- C It reduces the risk of an electric shock if the live wire touches the metal case.
- D The electric cooker will not switch on without it.

36 In an experiment, a wire is held above a compass needle as shown.

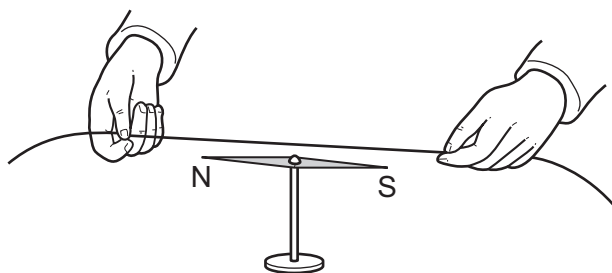

An electric current is switched on in the wire and the compass needle is deflected.

Which row explains why this happens and then describes what happens when the current is reversed?

	why this happens	what happens when the current is reversed
<b>A</b>	there is a magnetic field inside the wire	the compass needle deflects in the opposite direction
<b>B</b>	there is a magnetic field inside the wire	there is no effect on the compass needle
<b>C</b>	there is a magnetic field around the wire	the compass needle deflects in the opposite direction
<b>D</b>	there is a magnetic field around the wire	there is no effect on the compass needle

37 Which device relies upon the magnetic effect of an electric current?

- A** fuse
- B** relay
- C** thermistor
- D** variable resistor

38 Which statement about the structure of an atom is correct?

- A** It contains positively charged particles only.
- B** It contains negatively charged particles only.
- C** It contains no charged particles.
- D** It contains positively charged particles and negatively charged particles.

39 Which statement about  $\gamma$ -radiation is correct?

- A It consists of very small charged particles.
- B It is a form of electromagnetic radiation.
- C It is less penetrating than  $\beta$ -radiation.
- D It is more highly ionising than  $\alpha$ -radiation.

40 A radioactive element undergoes  $\alpha$ -decay.

Which statement is **not** correct?

- A A different element is formed.
- B Radiation is emitted from the nucleus.
- C The decay is a random process.
- D The number of particles in the nucleus stays the same.

---

Permission to reproduce items where third-party owned material protected by copyright is included has been sought and cleared where possible. Every reasonable effort has been made by the publisher (UCLES) to trace copyright holders, but if any items requiring clearance have unwittingly been included, the publisher will be pleased to make amends at the earliest possible opportunity.

To avoid the issue of disclosure of answer-related information to candidates, all copyright acknowledgements are reproduced online in the Cambridge Assessment International Education Copyright Acknowledgements Booklet. This is produced for each series of examinations and is freely available to download at [www.cambridgeinternational.org](http://www.cambridgeinternational.org) after the live examination series.

Cambridge Assessment International Education is part of the Cambridge Assessment Group. Cambridge Assessment is the brand name of the University of Cambridge Local Examinations Syndicate (UCLES), which itself is a department of the University of Cambridge.