



PHYSICS

0625/22

Paper 2 Multiple Choice (Extended)

February/March 2019

45 minutes

Additional Materials: Multiple Choice Answer Sheet
Soft clean eraser
Soft pencil (type B or HB recommended)

* 1 3 5 8 0 1 0 9 9 4 *

READ THESE INSTRUCTIONS FIRST

Write in soft pencil.

Do not use staples, paper clips, glue or correction fluid.

Write your name, centre number and candidate number on the Answer Sheet in the spaces provided unless this has been done for you.

DO NOT WRITE IN ANY BARCODES.

There are **forty** questions on this paper. Answer **all** questions. For each question there are four possible answers **A, B, C** and **D**.

Choose the **one** you consider correct and record your choice in **soft pencil** on the separate Answer Sheet.

Read the instructions on the Answer Sheet very carefully.

Each correct answer will score one mark. A mark will not be deducted for a wrong answer.

Any rough working should be done in this booklet.

Electronic calculators may be used.

Take the weight of 1.0 kg to be 10 N (acceleration of free fall = 10 m/s^2).

bestexamhelp.com

This syllabus is regulated for use in England, Wales and Northern Ireland as a Cambridge International Level 1/Level 2 Certificate.

This document consists of **15** printed pages and **1** blank page.

- 1 Which row shows the best choice of measuring instruments to obtain accurate values for the distances shown?

	diameter of wire	height of bench	length of laboratory
A	measuring tape	measuring tape	micrometer screw gauge
B	metre rule	micrometer screw gauge	measuring tape
C	micrometer screw gauge	measuring tape	metre rule
D	micrometer screw gauge	metre rule	measuring tape

- 2 An object is moving with uniform deceleration.

Which statement describes its motion?

- A** Its rate of change of speed is decreasing.
B Its speed is constant.
C Its speed is decreasing.
D Its speed is increasing.
- 3 The graph shows how the speed of a car varies during part of its journey.

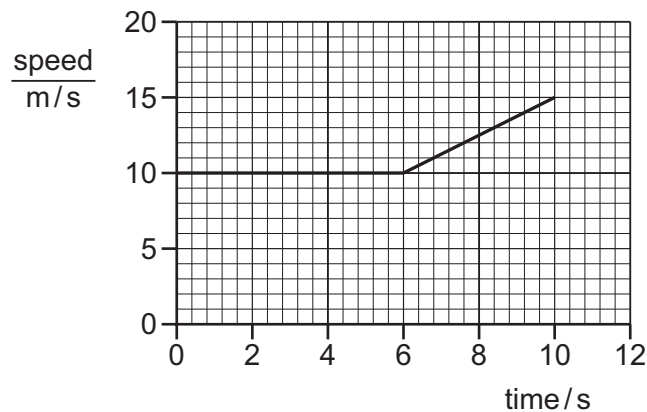

What is the value of the car's acceleration between 6 s and 10 s?

- A** 0.50 m/s^2 **B** 0.80 m/s^2 **C** 1.25 m/s^2 **D** 1.50 m/s^2

- 4 The gravitational field strength on the Moon is less than on the Earth.

Which of these is **different** when done on the Moon compared with when done on the Earth?

- A the gravitational potential energy gained by a stone lifted through the same vertical height
 - B the kinetic energy gained by a ball when hit with the same force for the same period of time
 - C the momentum gained by a bullet when fired from the same gun
 - D the work done in accelerating a stone from rest to the same speed
- 5 The mass of a full bottle of cooking oil is 1.30 kg.

When exactly half of the oil has been used, the mass of the bottle plus the remaining oil is 0.90 kg.

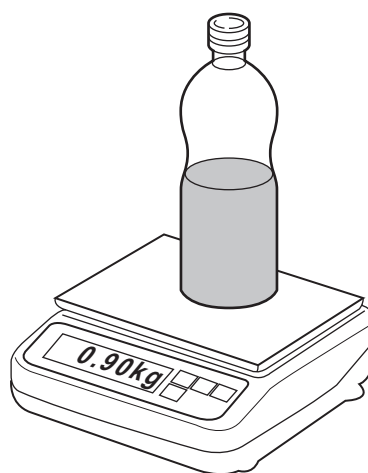
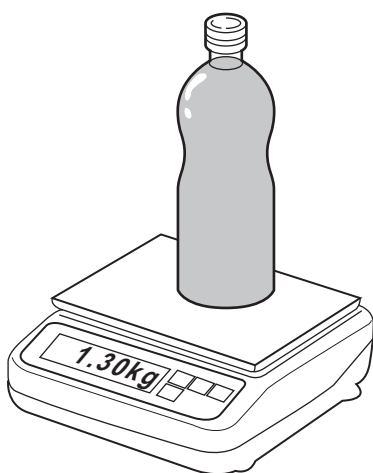

What is the mass of the empty bottle?

- A 0.40 kg
 - B 0.50 kg
 - C 0.65 kg
 - D 0.80 kg
- 6 A solid ball has a volume of 4.0 cm^3 . The density of the ball is 1.6 g/cm^3 .

What is the mass of the ball?

- A 0.4 g
- B 2.5 g
- C 4.0 g
- D 6.4 g

- 7 The extension/load graph for a spring is shown. The unstretched length of the spring is 15.0 cm.

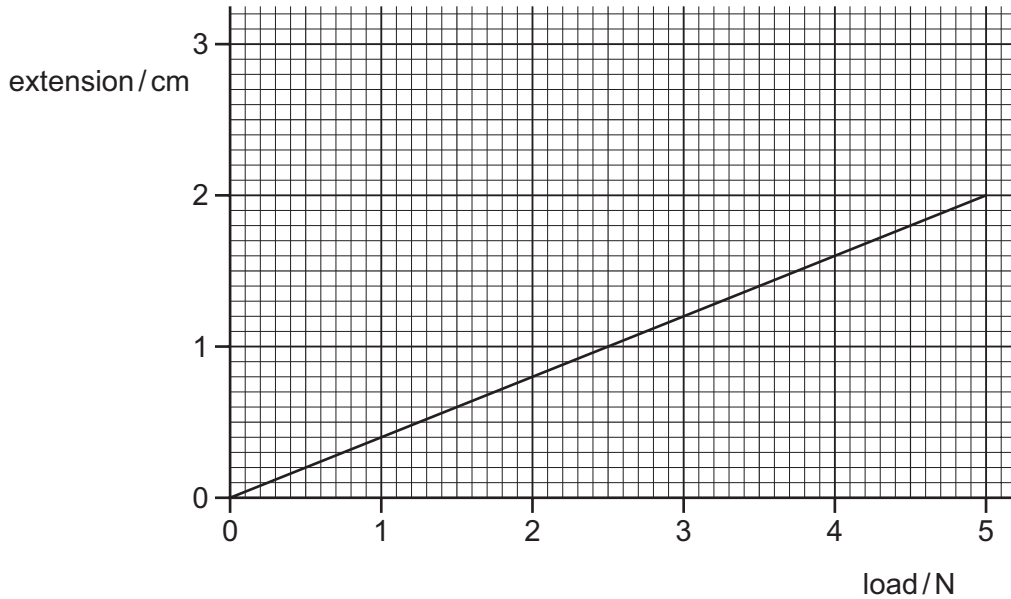

When an object of unknown weight is suspended on the spring, the length of the spring is 16.4 cm.

What is the weight of the object?

- A** 0.55 N **B** 0.67 N **C** 3.5 N **D** 4.1 N
- 8 A box of mass 2.0 kg is pulled across the floor by a force of 6.0 N.
The frictional force acting on the box is 1.0 N.
What is the acceleration of the box?
- A** 0.40 m/s² **B** 2.5 m/s² **C** 3.0 m/s² **D** 3.5 m/s²
- 9 Which moving body has a resultant force acting on it?
- A** a diver rising vertically through water at constant speed
B an aircraft circling an airport at constant speed
C a train going up a straight incline at constant speed
D a parachutist descending vertically at terminal velocity

- 10 A constant force acts on a body causing the momentum of the body to increase.

Which expression relates the force to the momentum and the time taken?

- A force = $\frac{\text{change in momentum}}{\text{time taken}}$
- B force = $\frac{\text{momentum}}{\text{time taken}}$
- C force = change in momentum \times time taken
- D force = momentum \times time taken

- 11 A car of mass 1500 kg has a speed of 20 m/s. It accelerates until its speed is 25 m/s.

What is the increase in the kinetic energy of the car?

- A 19 kJ B 38 kJ C 170 kJ D 340 kJ

- 12 Which source of energy uses the production of steam to generate electrical energy?

- A hydroelectric
- B nuclear
- C tides
- D waves

- 13 A car, travelling on a straight horizontal road, has 1.6 MJ of kinetic energy. It accelerates for 20 s until it has 2.5 MJ of kinetic energy.

What is the average power output used to increase the kinetic energy of the car?

- A 45 W B 205 W C 45 kW D 205 kW

- 14 Which diagram shows an athlete exerting least pressure on the ground?

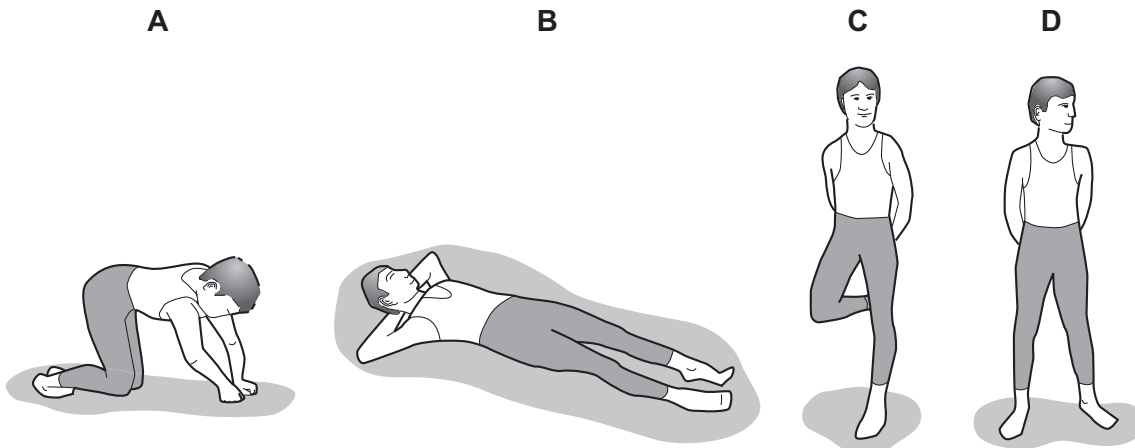

- 15 The diagram shows a U-tube manometer containing three liquids: mercury, liquid X and liquid Y. Neither liquid X or liquid Y mixes with mercury.

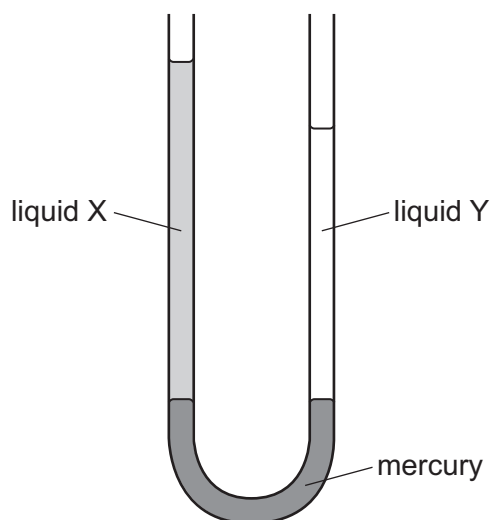

Which row compares the pressure exerted by liquid X and by liquid Y on the mercury, and the density of liquid X and the density of liquid Y?

	pressure exerted by X and by Y on the mercury	densities of X and of Y
A	pressure of X is greater than Y	density of X is greater than Y
B	pressure of Y is greater than X	density of Y is greater than X
C	pressure of X and of Y is the same	density of X is greater than Y
D	pressure of X and of Y is the same	density of Y is greater than X

- 16 Gas molecules exert a pressure when they collide with the walls of a container.

Which statement is correct?

- A** They experience a change in force which exerts a pressure equal to $\text{momentum} \times \text{area}$ on the walls.
- B** They experience a change in force which exerts a pressure equal to $\frac{\text{momentum}}{\text{area}}$ on the walls.
- C** They experience a change in momentum which exerts a pressure equal to $\text{force} \times \text{area}$ on the walls.
- D** They experience a change in momentum which exerts a pressure equal to $\frac{\text{force}}{\text{area}}$ on the walls.

- 17 A thermometer has graduations which start at -10°C and end at 110°C .

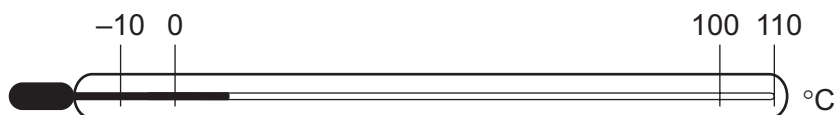

What is the lower fixed point and what is the upper fixed point of the Celsius scale?

	lower fixed point $/^{\circ}\text{C}$	upper fixed point $/^{\circ}\text{C}$
A	-10	100
B	-10	110
C	0	100
D	0	110

- 18 A 1 kg block of aluminium requires more thermal energy to raise its temperature by 1°C than a 1 kg block of copper requires.

Why is this?

- A** Aluminium is a better conductor of thermal energy than copper.
B Aluminium is a poorer conductor of thermal energy than copper.
C Aluminium has a higher specific heat capacity than copper.
D Aluminium has a lower specific heat capacity than copper.
- 19 Four campers are warming their food on a fire.

They use different rods, each of the same dimensions, to hold their food near the fire.

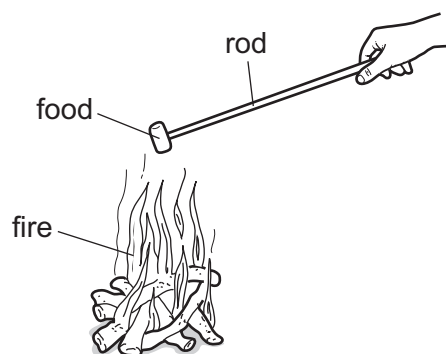

Which material is the best choice to prevent their hands from getting too hot?

- A** aluminium
B copper
C steel
D wood

- 20** Two metal cans are identical, except that one has a shiny silver outer surface and the other has a dull black outer surface. They each have 300 g of water at 80 °C sealed inside them. They are both in a vacuum, in the darkness of outer space.

How does the temperature of the water in each one change?

- A** Neither one will cool down.
B The water in the black can cools more slowly than that in the shiny can.
C The water in the shiny can cools more slowly than that in the black can.
D They both cool down at the same rate.
- 21** The diagram shows a wave before it reflects from a barrier.

Which labelled section of the diagram represents a wavefront?

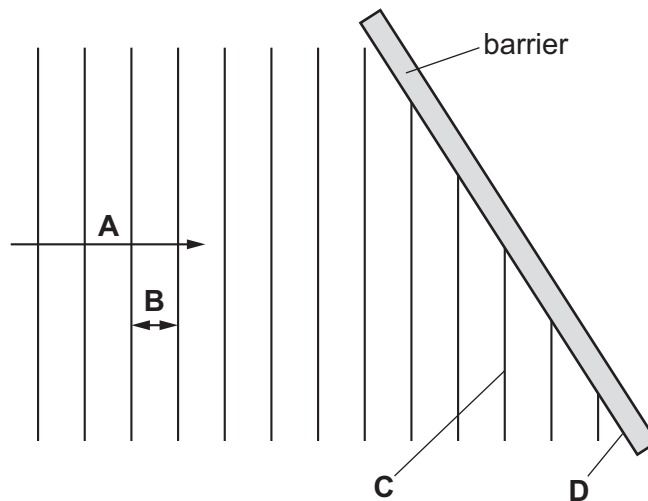

- 22** A vibrating object produces ripples on the surface of a liquid. The object completes 20 vibrations every second. The spacing of the ripples, from one crest to the next, is 3.0 cm.

What is the speed of the ripples?

- A** 0.15 cm/s **B** 6.7 cm/s **C** 60 cm/s **D** 120 cm/s

- 23 A narrow beam of light is travelling through a transparent liquid. It meets the surface as shown, at an angle of incidence of 40° . The refractive index of the liquid is 1.5.

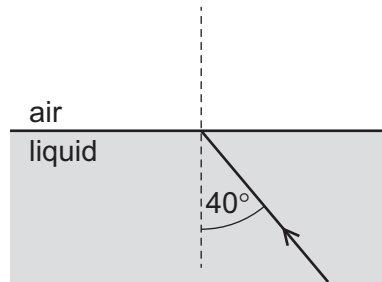

What is the angle of refraction as the light enters the air?

- A 25° B 27° C 60° D 75°
- 24 Which diagram correctly represents rays of light passing through a converging lens in a camera?

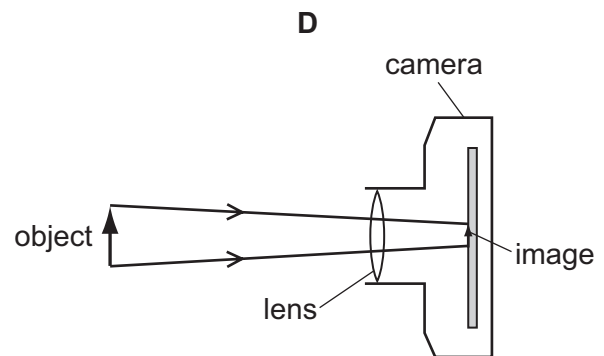
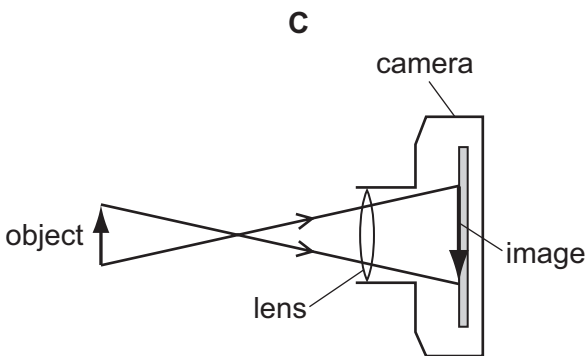
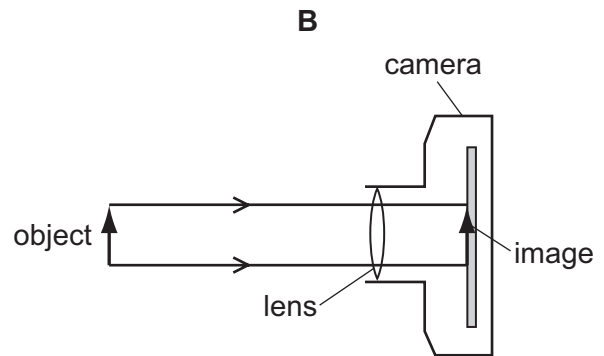
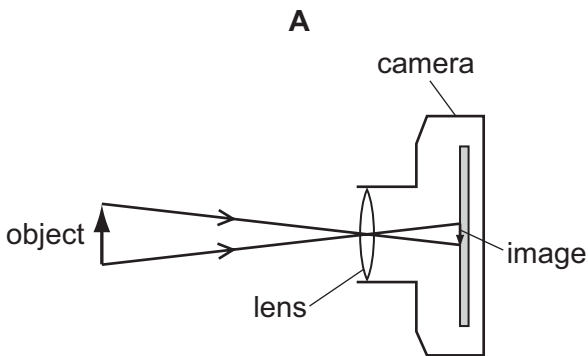

- 25 What is the speed of X-rays in a vacuum and in air?

	in a vacuum	in air
A	$3.0 \times 10^6 \text{ m/s}$	$2.0 \times 10^6 \text{ m/s}$
B	$3.0 \times 10^6 \text{ m/s}$	$3.0 \times 10^6 \text{ m/s}$
C	$3.0 \times 10^8 \text{ m/s}$	$2.0 \times 10^8 \text{ m/s}$
D	$3.0 \times 10^8 \text{ m/s}$	$3.0 \times 10^8 \text{ m/s}$

- 26** A sound wave passes a point. The air pressure at that point increases and then decreases 300 times every second.

Which descriptions apply to this sound wave?

	the type of wave motion	the frequency of the sound
A	longitudinal	outside human hearing range
B	longitudinal	within human hearing range
C	transverse	outside human hearing range
D	transverse	within human hearing range

- 27** A boy stands 150m from a wall. He claps and when he hears the echo, he immediately claps again. He continues this for some time.

Another student has a stop-watch. She starts the watch on the first clap and stops it on the eleventh clap. The watch reads 10.0s.

Which value do her measurements give for the speed of sound in air?

- A** 150 m/s **B** 170 m/s **C** 300 m/s **D** 330 m/s
- 28** The ends of three metal rods are tested by holding end Q of rod 1 close to the others in turn.

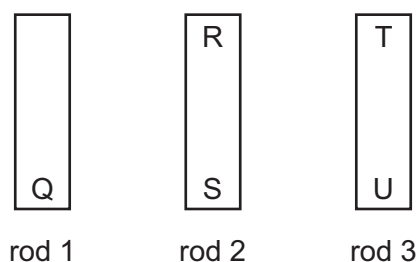

The results are as follows.

End Q attracts end R.

End Q attracts end S.

End Q attracts end T.

End Q repels end U.

Which of the metal rods is a magnet?

- A** rod 1 only
- B** rod 1 and rod 2
- C** rod 1 and rod 3
- D** rod 3 only

29 A metal sphere is charged by induction. There are four stages W, X, Y and Z in this process.

- W a charged rod is brought near to the sphere
- X the sphere is earthed
- Y the charged rod is taken away from the sphere
- Z the earth connection is removed

In which order are the four stages carried out?

- A $W \rightarrow X \rightarrow Y \rightarrow Z$
 - B $W \rightarrow X \rightarrow Z \rightarrow Y$
 - C $Z \rightarrow W \rightarrow X \rightarrow Y$
 - D $X \rightarrow Z \rightarrow W \rightarrow Y$
- 30 Which electrical quantity is defined in terms of the energy supplied in driving charge round a complete circuit?
- A current
 - B electromotive force
 - C potential difference
 - D power
- 31 A student sets up a circuit containing a battery of two cells and three lamps, as shown.

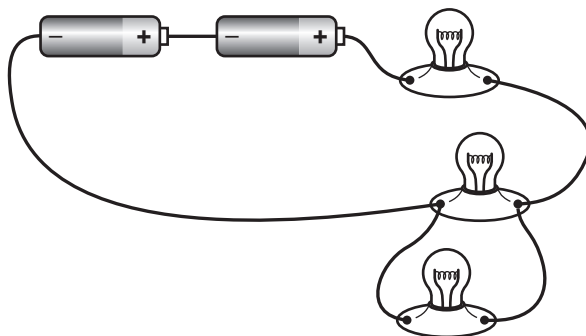

What is the circuit diagram for this arrangement?

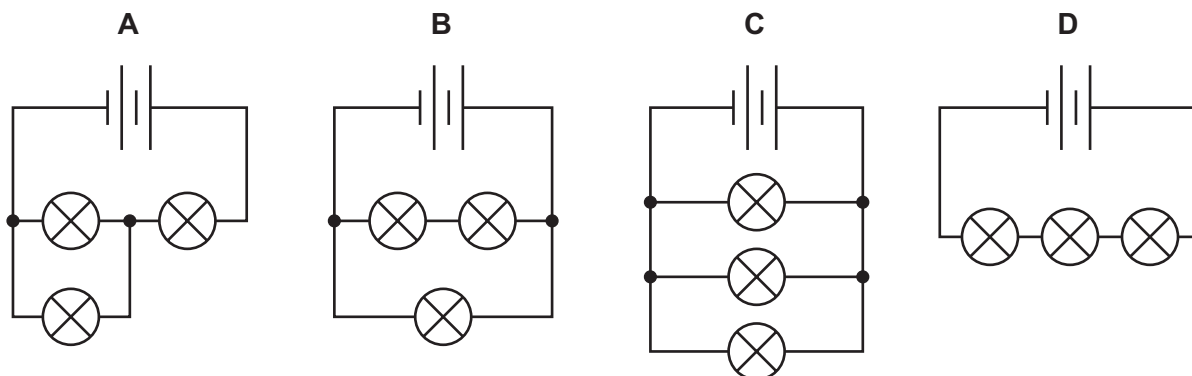

32 In which circuit does the lamp light?

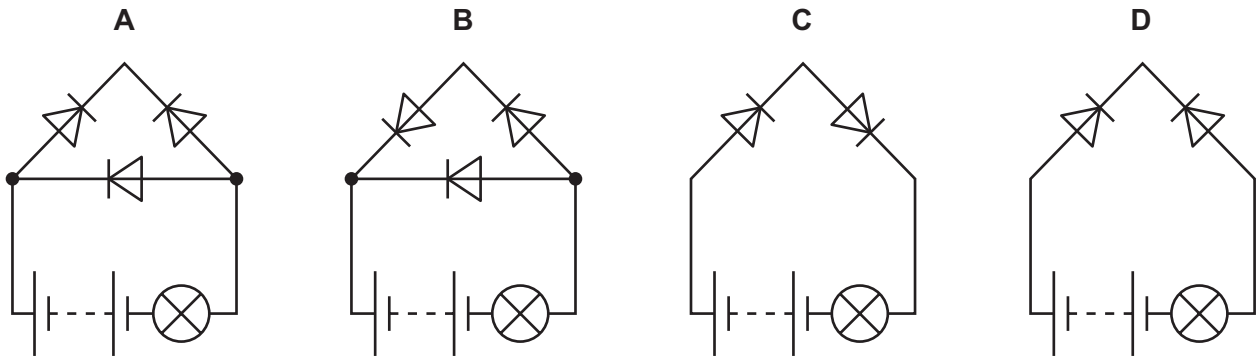

33 Each potential divider is placed in a circuit with a power supply.

Which potential divider makes the potential difference across component Y increase when the light intensity increases?

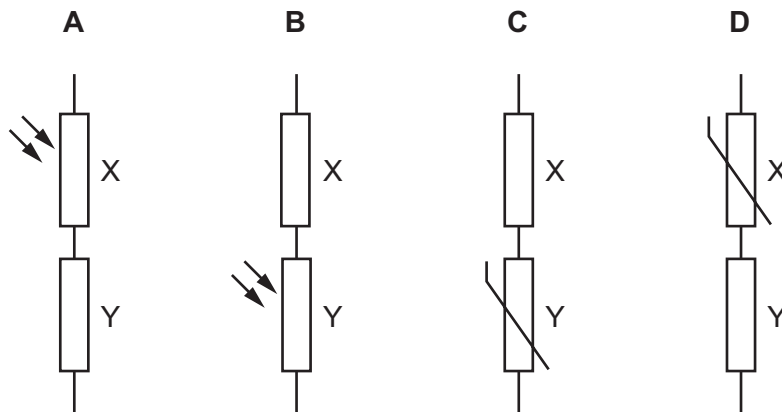

- 34 There are two inputs to the combination of logic gates shown, and one output.

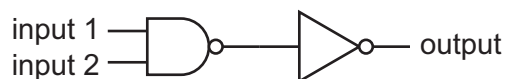

Which truth table represents the action of this combination of gates?

A

input 1	input 2	output
0	0	0
0	1	0
1	0	0
1	1	1

B

input 1	input 2	output
0	0	0
0	1	1
1	0	1
1	1	1

C

input 1	input 2	output
0	0	1
0	1	1
1	0	1
1	1	0

D

input 1	input 2	output
0	0	1
0	1	0
1	0	0
1	1	0

- 35 The current in a kettle is 10 A and the kettle is protected by a 13 A fuse.

The owner of the kettle replaces the 13 A fuse with a 3 A fuse.

What happens when the kettle is switched on?

- A** The fuse melts and the kettle might be damaged.
B The fuse melts and the kettle is undamaged.
C The fuse does not melt and the kettle works correctly.
D The fuse does not melt but the kettle fails to work.
- 36 Which statement about the direction of a magnetic field at a point is correct?
- A** It is the direction of the force on a north pole placed at that point.
B It is the direction of the force on a south pole placed at that point.
C It is the direction of the force on a positive charge placed at that point.
D It is the direction of the force on a negative charge placed at that point.

40 A beta particle is a fast moving electron.

Which statement explains how beta particles are emitted from an atom?

- A** An electron is emitted as a beta particle from an inner electron shell of the atom.
- B** An electron is emitted as a beta particle from an outer electron shell of the atom.
- C** A neutron changes into a proton and a beta particle is emitted from the nucleus.
- D** A proton changes into a neutron and a beta particle is emitted from the nucleus.

BLANK PAGE

Permission to reproduce items where third-party owned material protected by copyright is included has been sought and cleared where possible. Every reasonable effort has been made by the publisher (UCLES) to trace copyright holders, but if any items requiring clearance have unwittingly been included, the publisher will be pleased to make amends at the earliest possible opportunity.

To avoid the issue of disclosure of answer-related information to candidates, all copyright acknowledgements are reproduced online in the Cambridge Assessment International Education Copyright Acknowledgements Booklet. This is produced for each series of examinations and is freely available to download at www.cambridgeinternational.org after the live examination series.

Cambridge Assessment International Education is part of the Cambridge Assessment Group. Cambridge Assessment is the brand name of the University of Cambridge Local Examinations Syndicate (UCLES), which itself is a department of the University of Cambridge.