



Cambridge International Examinations
Cambridge International General Certificate of Secondary Education

PHYSICS

0625/12

Paper 1 Multiple Choice (Core)

May/June 2017

45 minutes

Additional Materials: Multiple Choice Answer Sheet
Soft clean eraser
Soft pencil (type B or HB recommended)



READ THESE INSTRUCTIONS FIRST

Write in soft pencil.

Do not use staples, paper clips, glue or correction fluid.

Write your name, Centre number and candidate number on the Answer Sheet in the spaces provided unless this has been done for you.

DO NOT WRITE IN ANY BARCODES.

There are **forty** questions on this paper. Answer **all** questions. For each question there are four possible answers **A, B, C** and **D**.

Choose the **one** you consider correct and record your choice in **soft pencil** on the separate Answer Sheet.

Read the instructions on the Answer Sheet very carefully.

Each correct answer will score one mark. A mark will not be deducted for a wrong answer.

Any rough working should be done in this booklet.

Electronic calculators may be used.

Take the weight of 1.0 kg to be 10 N (acceleration of free fall = 10 m/s^2).

bestexamhelp.com

The syllabus is approved for use in England, Wales and Northern Ireland as a Cambridge International Level 1/Level 2 Certificate.

This document consists of **20** printed pages.

- 1 Which device is used to measure the time it takes for a 10 cm^3 block of ice to melt in a laboratory at room temperature?
- A measuring cylinder
B ruler
C stopwatch
D thermometer
- 2 A student determines the average speed of a bubble rising through a liquid at constant speed.
- When the student starts the stopwatch the bubble is at position P.
- After 2.0 s the bubble is at position Q.

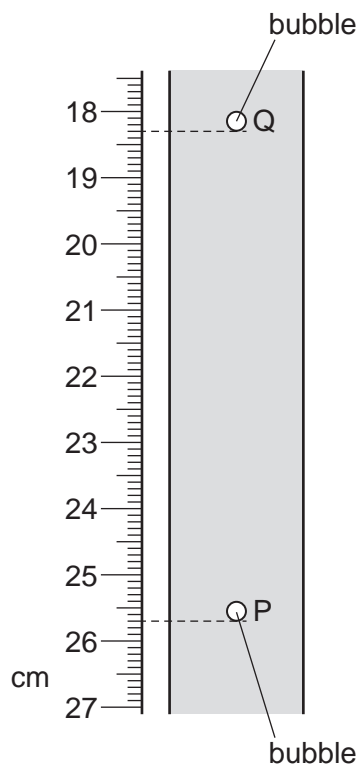

What is the speed of the bubble between P and Q?

- A 3.2 cm/s B 3.7 cm/s C 6.4 cm/s D 7.4 cm/s

- 3 The speed-time graph represents a motorcycle journey.

In which part of the graph is the acceleration equal to zero?

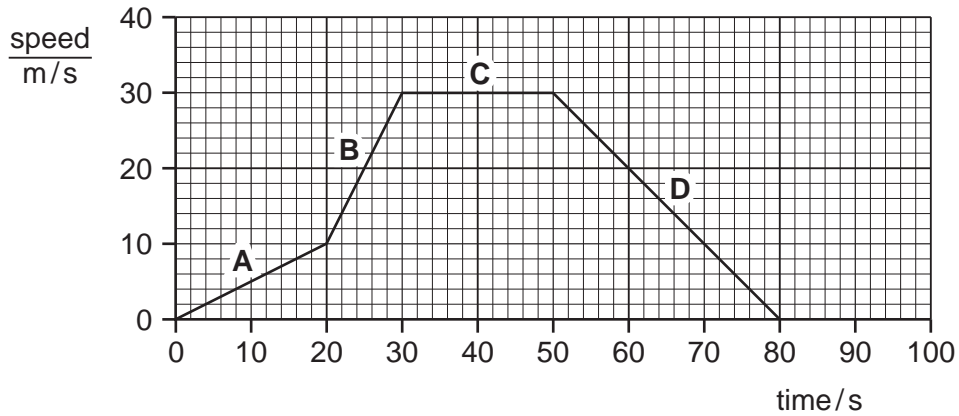

- 4 Which expression is used to find gravitational field strength g ?

- A mass \times density
- B mass \div weight
- C weight \times mass
- D weight \div mass

- 5 A block of ice is removed from a freezer. Some of the ice melts to produce water. Some of the water that is produced evaporates.

The original mass of the ice is p . The mass of the ice that has not yet melted is q . The mass of the water is r . The mass of the water vapour is s .

The diagram shows these changes.

before melting

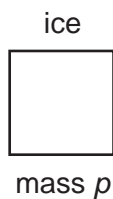

after melting and evaporation

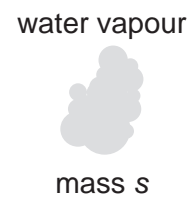
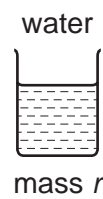
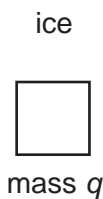

Which equation gives the relationship between p , q , r and s ?

- A $p = q + r$
- B $p = q + r + s$
- C $p = q + r - s$
- D $p = q + s$

- 6 The masses of a measuring cylinder before and after pouring some liquid into it are shown in the diagram.

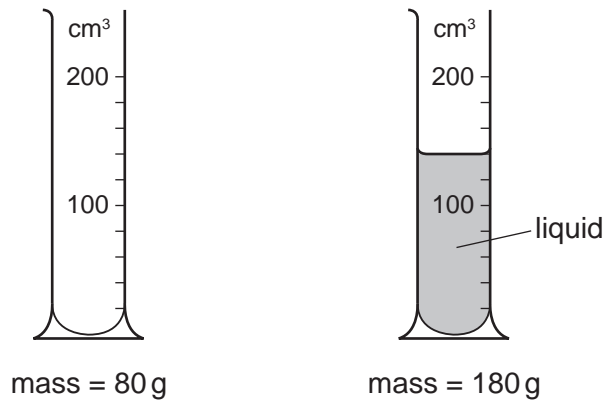

What is the density of the liquid?

- A $\frac{100}{120} \text{ g/cm}^3$ B $\frac{100}{140} \text{ g/cm}^3$ C $\frac{180}{120} \text{ g/cm}^3$ D $\frac{180}{140} \text{ g/cm}^3$
- 7 A car travels forwards along a straight horizontal road. Only the horizontal forces acting on it are shown.

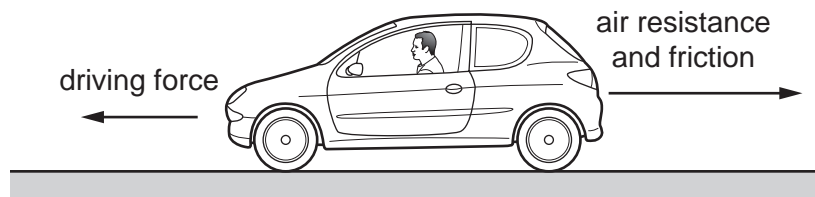

The length of each arrow represents the size of each force.

How do these forces affect the motion of the car?

- A The car moves at constant speed.
 B The car moves backwards.
 C The car slows down.
 D The car's forward speed increases.

- 8 The centre of a uniform metre rule rests on a pivot. A load of weight 3.0 N is placed at the 70 cm mark.

A force F acts upwards at the 80 cm mark. The rule is in equilibrium.

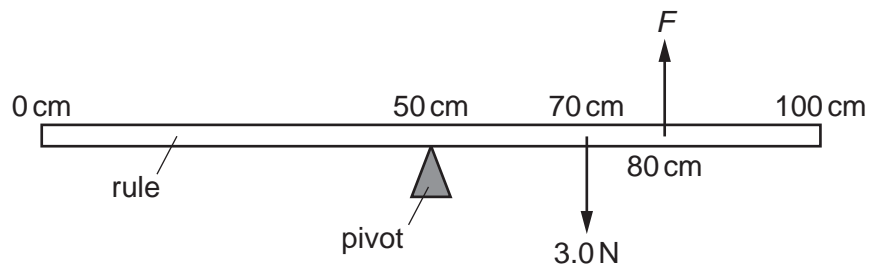

What is the magnitude of F ?

- A 2.0 N B 2.6 N C 3.0 N D 4.5 N
- 9 An energy resource is used to generate electrical energy.
- Which energy resource uses a transfer of gravitational potential energy to generate this electrical energy?
- A geothermal
B hydroelectric
C solar
D wind

10 The diagrams show athletes training by stretching springs.

Each spring has the same stiffness.

Which athlete does the most work?

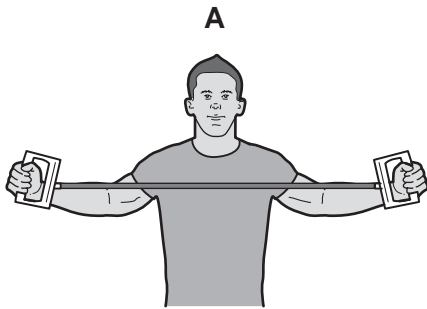

one spring stretched
by 0.60 m

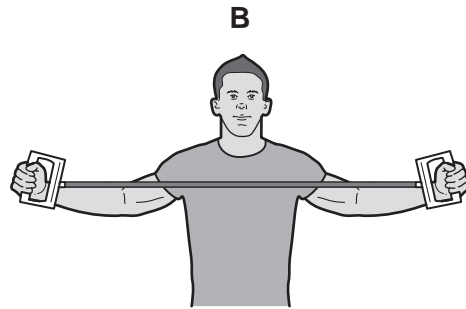

one spring stretched
by 0.80 m

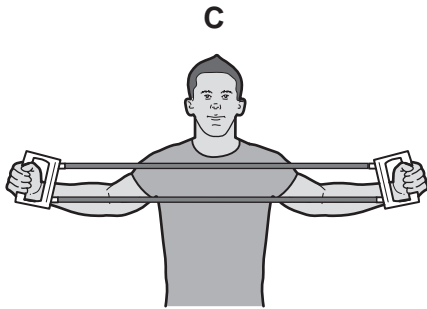

two springs stretched
by 0.60 m

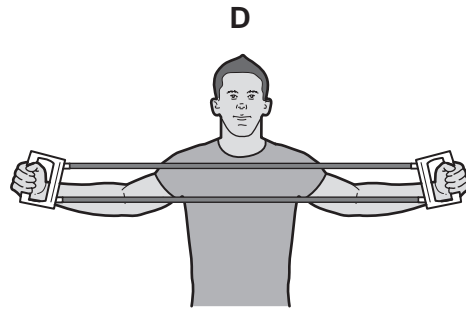

two springs stretched
by 0.80 m

11 The diagram shows a conical vessel full of water.

The pressure at point X due to the water is p . A point Q is a distance h above point X.

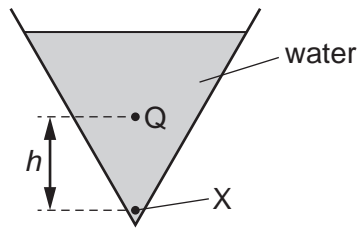

Which graph shows how the pressure due to the water at Q varies with distance h ?

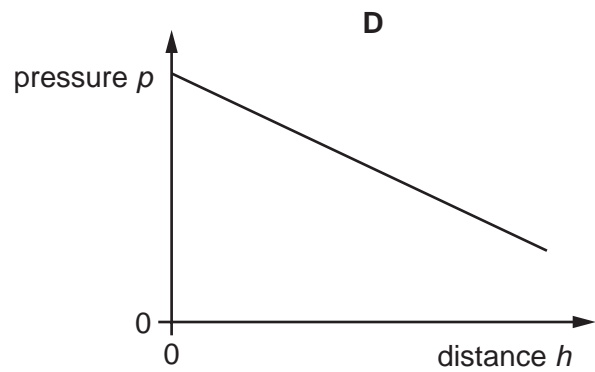
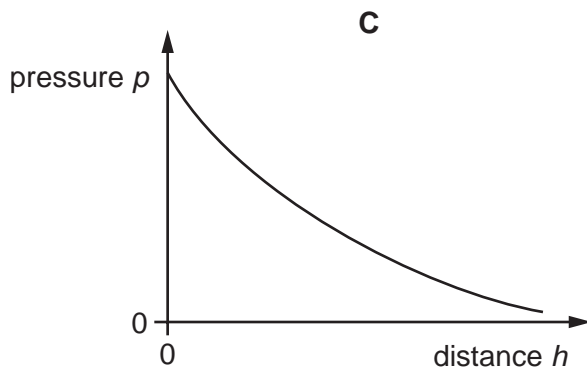
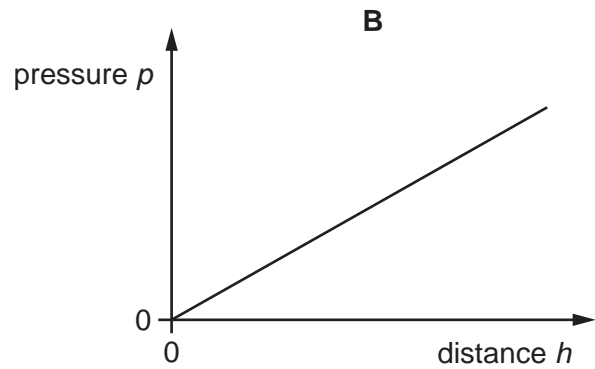
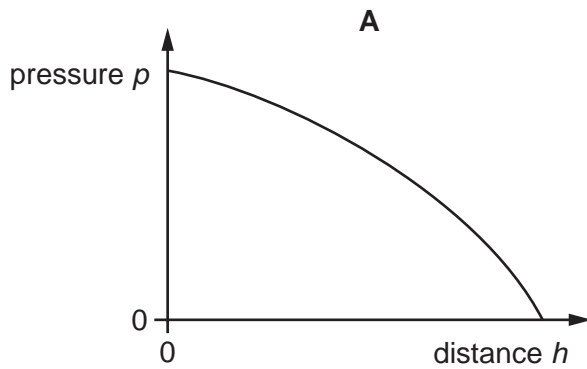

- 12 In diagram 1 a manometer containing mercury (Hg) is connected to a gas tap. The tap is turned off and the mercury is at the same level on both sides.

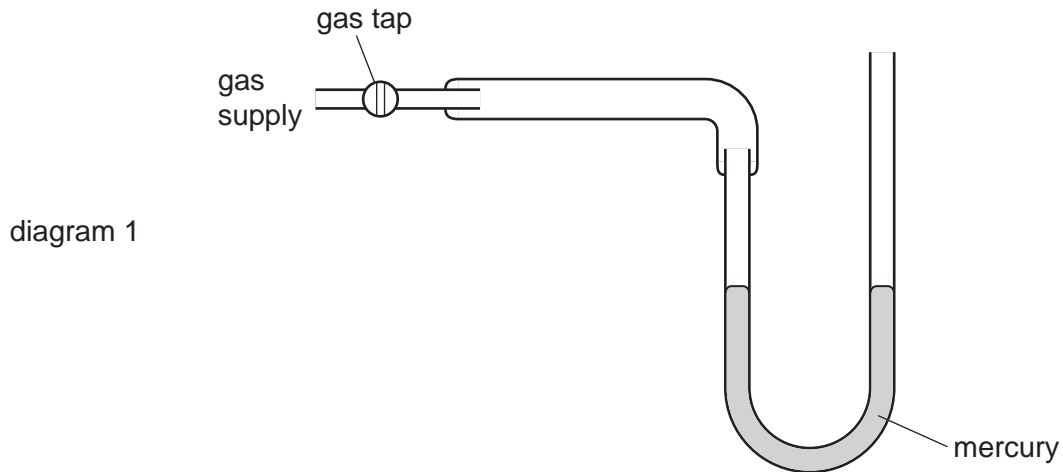

When the gas supply is turned on, the mercury in the tube connected to the supply falls by 40 mm and the mercury in the tube open to the atmosphere rises by 40 mm, as shown in diagram 2.

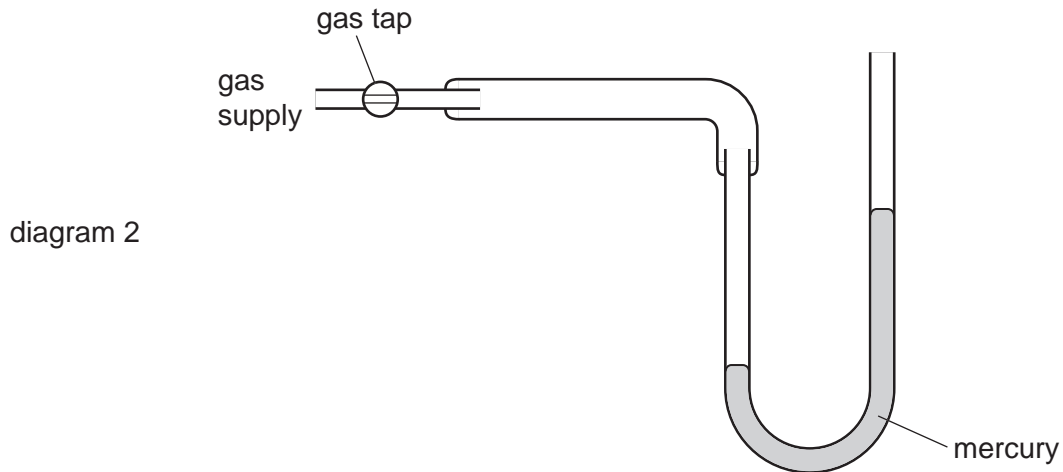

What is the pressure of the gas in the gas supply?

- A 40 mm Hg above atmospheric pressure
- B 40 mm Hg below atmospheric pressure
- C 80 mm Hg above atmospheric pressure
- D 80 mm Hg below atmospheric pressure

13 Brownian motion is observed when using a microscope to look at smoke particles in air.

What causes the smoke particles to move at random?

- A Smoke particles are hit by air molecules.
- B Smoke particles are moved by convection currents in the air.
- C Smoke particles have different weights and fall at different speeds.
- D Smoke particles hit the walls of the container.

14 Which change is evaporation?

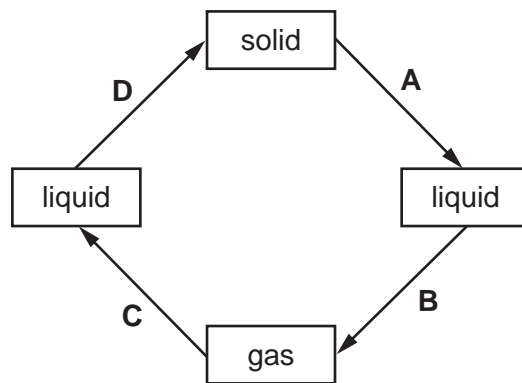

15 A glass bottle has a metal cap. The cap fits very tightly and is difficult to remove.

The cap and the neck of the bottle are dipped in a bowl of hot water. The cap can be removed more easily.

What happens to allow the cap to be removed more easily from the bottle?

- A The cap contracts.
- B The cap expands.
- C The glass bottle contracts.
- D The glass bottle expands.

16 Equal masses of two different liquids are put into identical beakers.

Liquid 1 is heated for 100 s and liquid 2 is heated for 200 s by heaters of the **same power**.

Each liquid has the same rise in temperature.

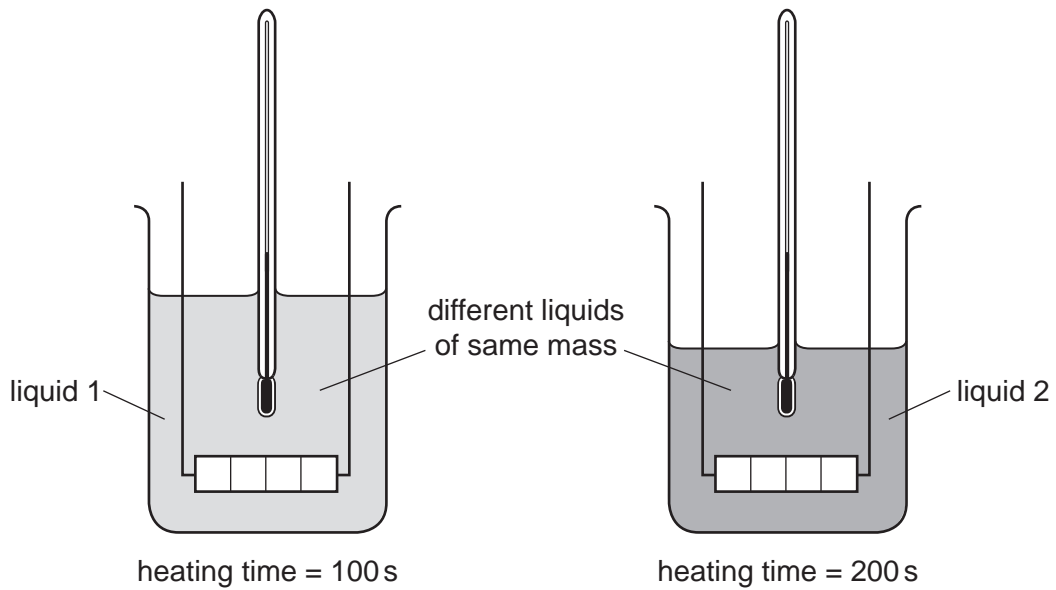

Which statement is correct?

- A Each beaker of liquid has the same thermal capacity.
- B Each beaker of liquid receives the same energy.
- C Liquid 1 receives more energy than liquid 2.
- D The thermal capacity of liquid 1 is less than the thermal capacity of liquid 2.

- 17 A copper bar and a wooden bar are joined. A piece of paper is wrapped tightly around the join.

The bar is heated strongly at the centre for a short time, and the paper goes brown on one side only.

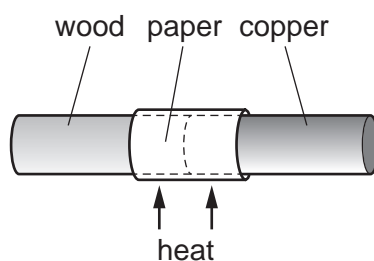

Which side goes brown, and what does this show about wood and copper?

	brown side	wood	copper
A	copper	conductor	insulator
B	copper	insulator	conductor
C	wood	conductor	insulator
D	wood	insulator	conductor

- 18 A glass of water is taken out of a refrigerator. Several ice cubes are put into the glass of water. The glass is then left in the room for several hours.

The graph shows how the temperature of the water in the glass varies from the time it is taken out of the refrigerator.

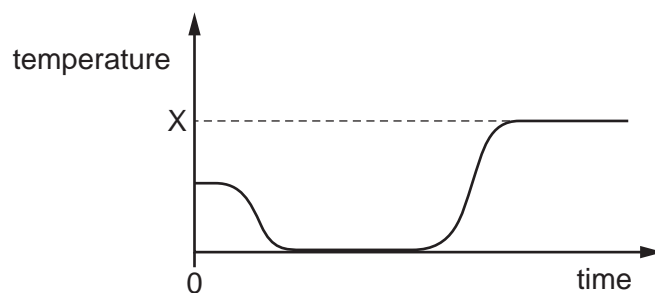

What does the temperature marked X represent?

- A** boiling point of water
- B** melting point of ice
- C** room temperature
- D** temperature inside refrigerator

19 A hollow aluminium cube is filled with very hot water.

Side X of the cube is opposite side Y of the cube. One of these two sides is black and one is white.

A student holds the back of one hand 5 cm from side X, and then immediately holds the back of the other hand 5 cm from side Y.

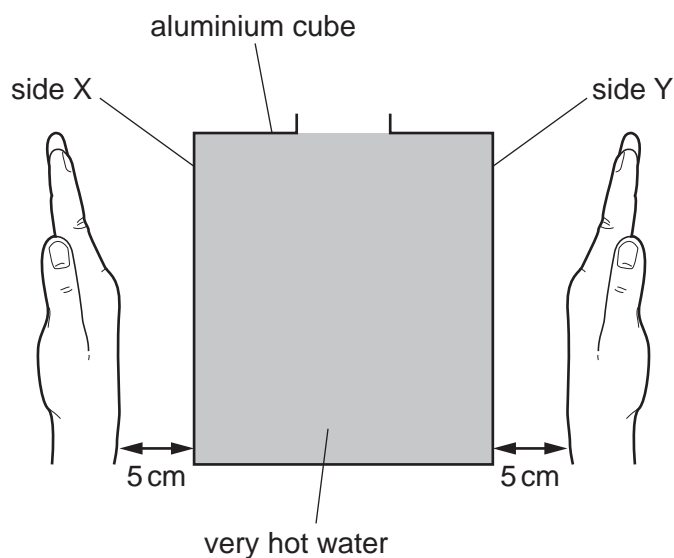

The hand held near side Y feels warmer than the hand held near side X.

Which row identifies the black side and correctly compares the rate of emission of thermal radiation from each side?

	black side	rate of emission of thermal radiation
A	X	greater for X
B	X	the same for X and Y
C	Y	greater for Y
D	Y	the same for X and Y

20 What causes the change in direction when light travels from air into glass?

- A** The amplitude of the light changes.
- B** The colour of the light changes.
- C** The frequency of the light changes.
- D** The speed of the light changes.

21 Light passes into a glass block.

Which is the angle of refraction?

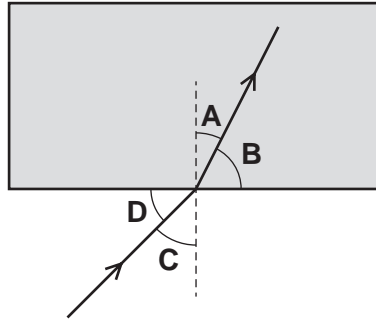

22 Which diagram shows what happens when a ray of white light passes through a prism?

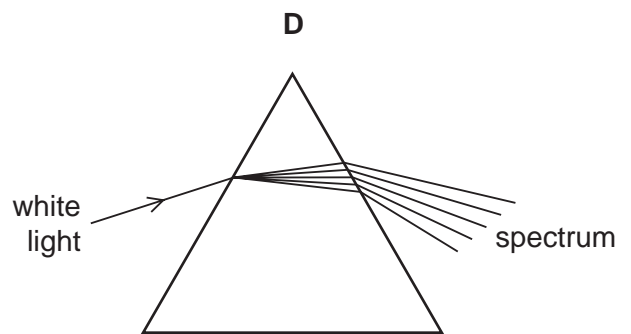
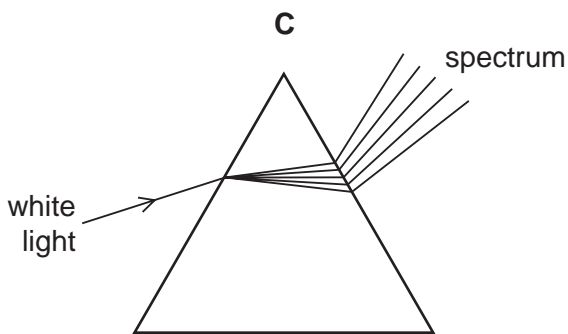
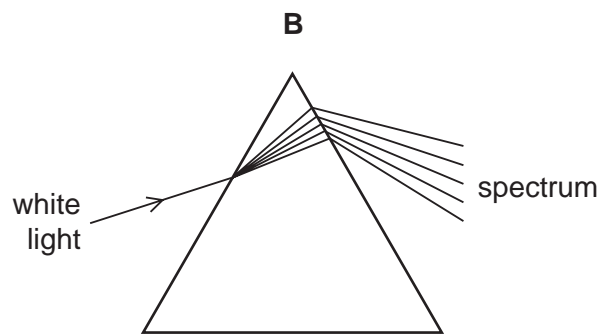
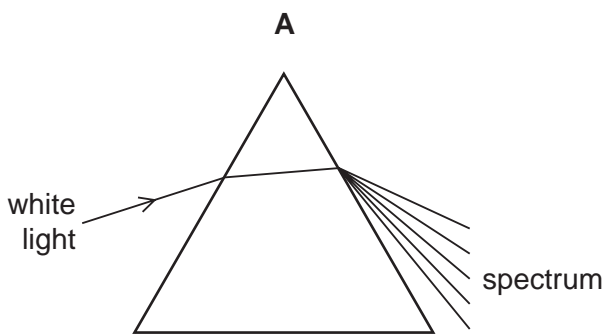

23 The diagrams show four sources of waves.

Which source produces longitudinal waves?

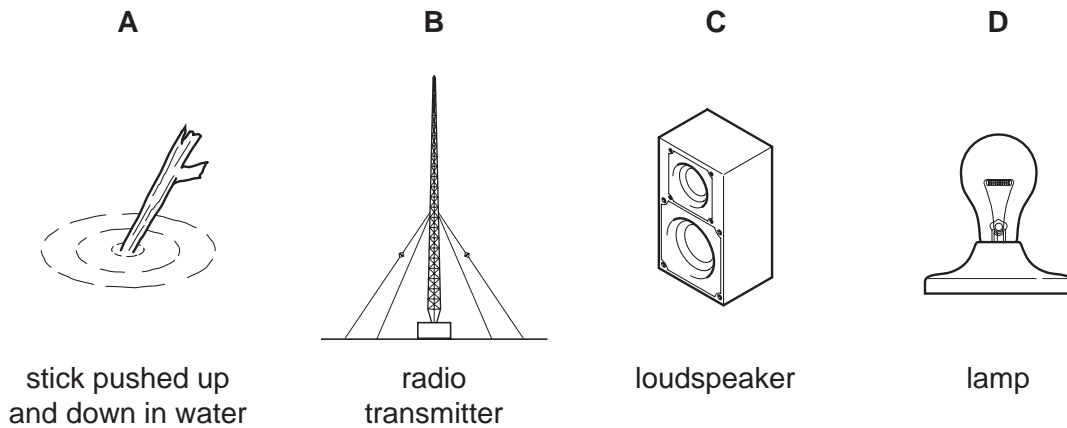

24 The table shows different types of wave in the electromagnetic spectrum.

radio waves	micro-waves	infra-red waves	visible light	ultraviolet waves	X-rays	gamma rays
-------------	-------------	-----------------	---------------	-------------------	--------	------------

Where do all the waves travel at the same speed?

- A** in a vacuum
- B** in diamond
- C** in glass
- D** in water

25 A fire alarm is not loud enough and the pitch is too low. An engineer adjusts the alarm so that it produces a louder note of a higher pitch.

What effect does this have on the amplitude and on the frequency of the sound?

	amplitude	frequency
A	larger	greater
B	larger	smaller
C	smaller	greater
D	smaller	smaller

26 What is wrong with this labelled diagram of a permanent magnet?

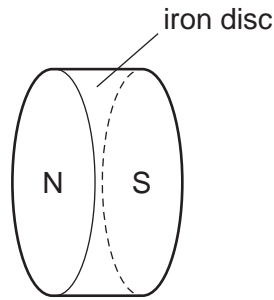

- A The cross-section should be rectangular.
- B The length should be greater than the diameter.
- C The magnet should be made of steel.
- D The N-pole and the S-pole should be reversed.
- 27 Which statement about magnetism is correct?
- A An unmagnetised iron bar becomes magnetised when it is placed near a magnet.
- B An unmagnetised steel bar can be magnetised by passing a current through it.
- C Steel is used as the core of an electromagnet.
- D When an iron bar has been magnetised, it is difficult to demagnetise it.
- 28 A student tests the electrical conduction of four materials.

aluminium

iron

plastic

silver

Which materials conduct electricity?

- A aluminium, iron and silver only
- B aluminium and silver only
- C iron, silver and plastic only
- D plastic only

29 The circuit diagram shows three resistors connected in series across a 6.0 V supply.

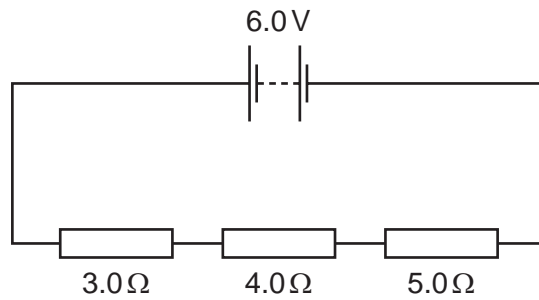

What is the potential difference (p.d.) across the 4.0Ω resistor?

- A** 0.67V **B** 1.5V **C** 2.0V **D** 6.0V

30 A thermistor is connected in series with a sensitive ammeter and a battery.

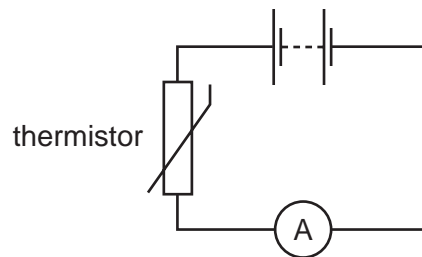

Which change will give a larger ammeter reading?

- A** adding another thermistor in series
B cooling the thermistor
C heating the thermistor
D reducing the number of cells in the battery

- 31 Three ammeters measure the currents in different parts of the circuit shown. The diagram indicates the reading on the ammeters.

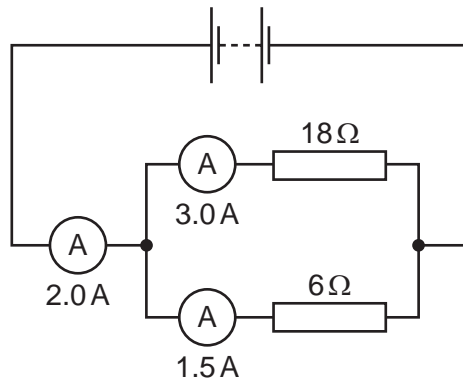

How do we know that at least one of the ammeters must be faulty?

- A All three ammeters must read the same value.
 - B All the current takes the easier path through the $6\ \Omega$ resistor.
 - C The current from the battery must be equal to the sum of the currents in the two resistors.
 - D The current in the two parallel resistors must be the same.
- 32 A student connects a variable potential divider (potentiometer) circuit.

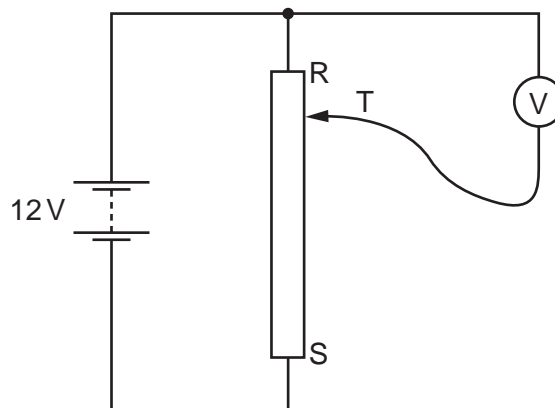

What happens to the reading on the voltmeter as the sliding terminal T is moved from R to S?

- A It decreases from 12 V to 0 V.
- B It increases from 0 V to 12 V.
- C It remains at 0 V.
- D It remains at 12 V.

33 The diagram shows an electric circuit.

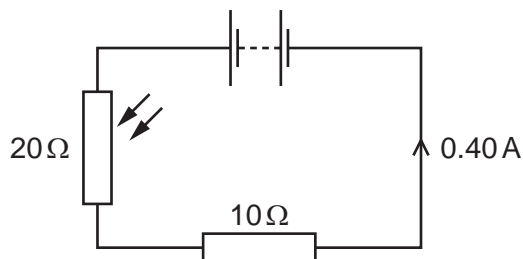

What is the potential difference (p.d.) across the LDR?

- A** 4.0V **B** 8.0V **C** 25V **D** 50V

34 A circuit-breaker is designed to protect a circuit which usually carries a current of 2 A.

The time taken to break the circuit depends on the current, as shown in the graph.

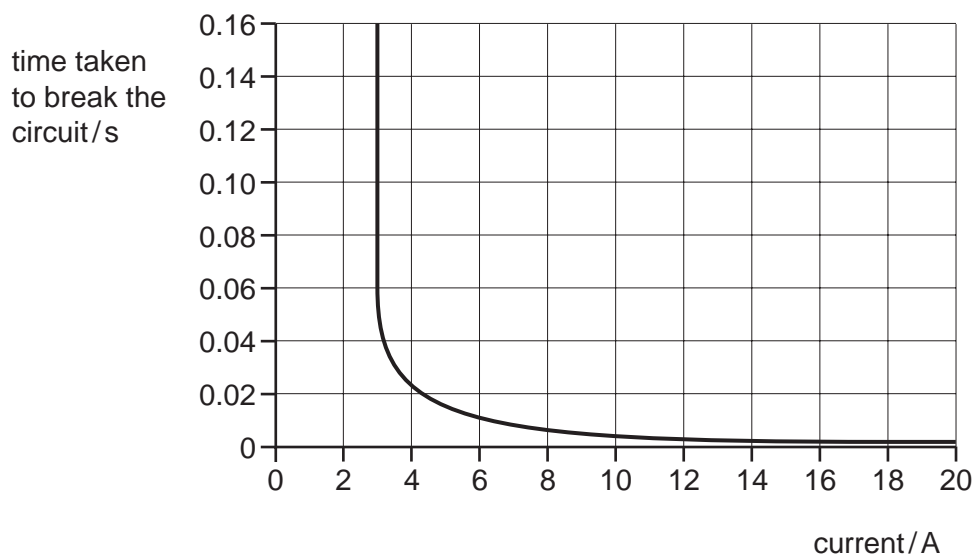

What happens when the current in the circuit is 2 A and what happens when the current is 18 A?

	when the current is 2 A	when the current is 18 A
A	the circuit breaks in less than 0.01 s	the circuit breaks in less than 0.01 s
B	the circuit breaks in less than 0.01 s	the circuit does not break
C	the circuit does not break	the circuit breaks in less than 0.01 s
D	the circuit does not break	the circuit does not break

- 35 What is the purpose of a relay?
- A to change a large voltage into a small voltage
 - B to change a small voltage into a large voltage
 - C to use a large current to switch on a small current
 - D to use a small current to switch on a large current
- 36 A coil of four loops of wire is placed in a magnetic field. When there is a current, the coil experiences a turning effect.

Some extra loops of wire are wound on the coil but the current is unchanged.

How does this affect the turning effect?

- A It is unchanged.
 - B Its direction changes.
 - C It decreases.
 - D It increases.
- 37 Which particle has a negative charge?
- A an alpha particle
 - B an electron
 - C a neutron
 - D a proton

- 38 The diagram represents the nucleus of an atom. The charged particles are shown.

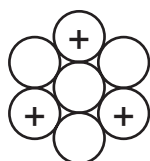

Which row gives the proton number and the nucleon number for this nucleus?

	proton number	nucleon number
A	3	4
B	3	7
C	4	3
D	4	7

39 A sample of radioactive isotope is decaying.

The nuclei of which atoms will decay first?

- A** It is impossible to know because radioactive decay is random.
- B** It is impossible to know unless the age of the material is known.
- C** The atoms near the centre will decay first because they are surrounded by more atoms.
- D** The atoms near the surface will decay first because the radiation can escape more easily.

40 The half-life of a radioactive isotope is 4.0 years.

A sample of this material contains 24 million radioactive nuclei.

How many of these radioactive nuclei remain undecayed after 12 years?

- A** 0.5 million
- B** 2.0 million
- C** 3.0 million
- D** 6.0 million

Permission to reproduce items where third-party owned material protected by copyright is included has been sought and cleared where possible. Every reasonable effort has been made by the publisher (UCLES) to trace copyright holders, but if any items requiring clearance have unwittingly been included, the publisher will be pleased to make amends at the earliest possible opportunity.

To avoid the issue of disclosure of answer-related information to candidates, all copyright acknowledgements are reproduced online in the Cambridge International Examinations Copyright Acknowledgements Booklet. This is produced for each series of examinations and is freely available to download at www.cie.org.uk after the live examination series.

Cambridge International Examinations is part of the Cambridge Assessment Group. Cambridge Assessment is the brand name of University of Cambridge Local Examinations Syndicate (UCLES), which is itself a department of the University of Cambridge.