



Cambridge International Examinations
Cambridge International General Certificate of Secondary Education

PHYSICS

0625/22

Paper 2 Multiple Choice (Extended)

May/June 2016

45 minutes

Additional Materials: Multiple Choice Answer Sheet
Soft clean eraser
Soft pencil (type B or HB recommended)

* 5 7 6 2 4 2 4 1 5 7 *

READ THESE INSTRUCTIONS FIRST

Write in soft pencil.

Do not use staples, paper clips, glue or correction fluid.

Write your name, Centre number and candidate number on the Answer Sheet in the spaces provided unless this has been done for you.

DO NOT WRITE IN ANY BARCODES.

There are **forty** questions on this paper. Answer **all** questions. For each question there are four possible answers **A, B, C** and **D**.

Choose the **one** you consider correct and record your choice in **soft pencil** on the separate Answer Sheet.

Read the instructions on the Answer Sheet very carefully.

Each correct answer will score one mark. A mark will not be deducted for a wrong answer.

Any rough working should be done in this booklet.

Electronic calculators may be used.

Take the weight of 1.0 kg to be 10 N (acceleration of free fall = 10 m/s^2).

bestexamhelp.com

The syllabus is approved for use in England, Wales and Northern Ireland as a Cambridge International Level 1/Level 2 Certificate.

This document consists of **16** printed pages.

- 1 The diagram shows an enlarged drawing of the end of a metre rule. It is being used to measure the length of a small feather.

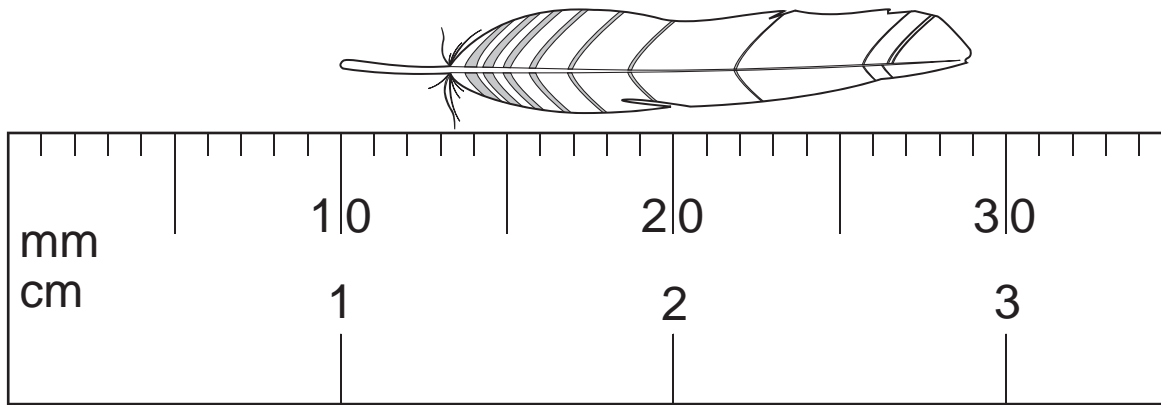

What is the length of the feather?

- A** 19 mm **B** 29 mm **C** 19 cm **D** 29 cm
- 2 A car travels along a straight road.
The speed-time graph for this journey is shown.
During which labelled part of the journey is the resultant force on the car zero?

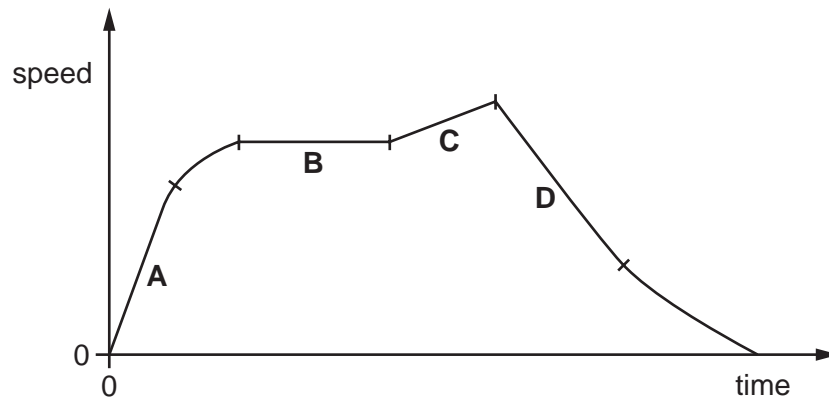

- 3 A large stone is dropped from a bridge into a river. Air resistance can be ignored.
Which row describes the acceleration and the speed of the stone as it falls?

	acceleration of the stone	speed of the stone
A	constant	constant
B	constant	increasing
C	increasing	constant
D	increasing	increasing

- 4 A cup contains hot liquid.

Some of the liquid evaporates.

What happens to the mass and what happens to the weight of the liquid in the cup?

	mass	weight
A	decreases	decreases
B	decreases	stays the same
C	stays the same	decreases
D	stays the same	stays the same

- 5 Below are four statements about acceleration.

Which statement is **not** correct?

- A** Acceleration always involves changing speed.
B Changing direction always involves acceleration.
C Changing speed always involves acceleration.
D Circular motion always involves acceleration.
- 6 The diagram shows a non-uniform beam of weight 120 N, pivoted at one end. The beam is kept in equilibrium by force F .

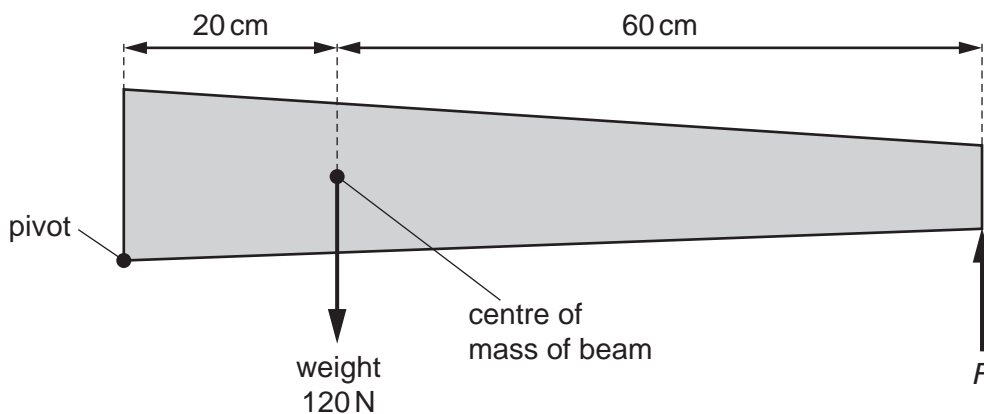

What is the value of force F ?

- A** 30 N **B** 40 N **C** 360 N **D** 480 N

- 7 An object is acted upon by a 3 N force and by a 4 N force.

Each diagram shows the two forces.

Which diagram also shows the resultant X of these two forces?

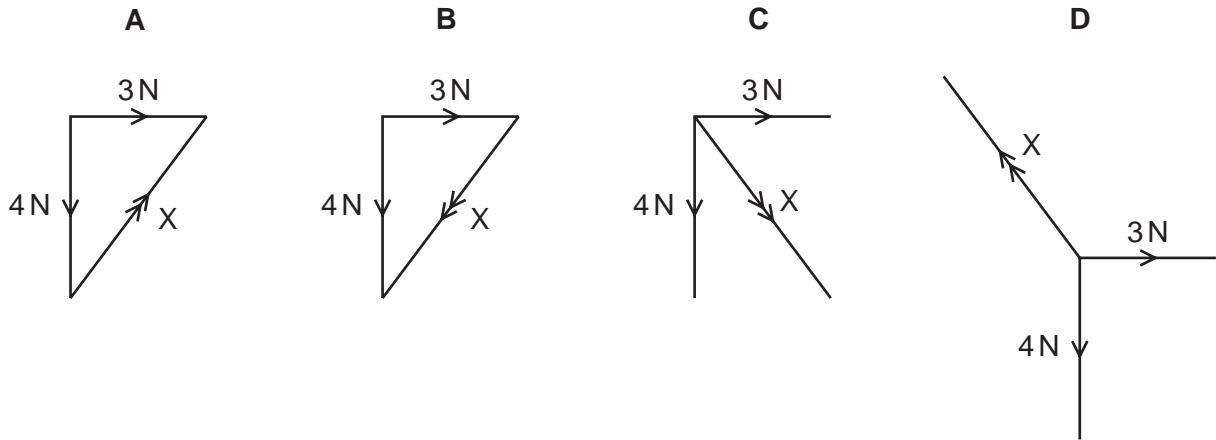

- 8 The engine of a car produces a driving force of 5000 N on the car. Resistive forces R also act on the car, as shown.

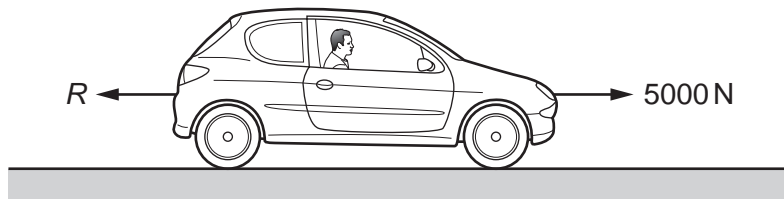

The car has a mass of 800 kg and an acceleration of 1.0 m/s^2 .

What is the value of R ?

- A** 800 N **B** 4200 N **C** 5800 N **D** 8000 N
- 9 A stone of mass m is held at rest in water. The stone is released and falls vertically a distance h . The stone reaches a speed v .

Some of the original energy of the stone is transferred to the water. As it falls, resistive forces cause the temperature of the water and stone to increase.

Which expression gives the work done against the resistive forces?

- A** $\frac{1}{2}mv^2$
- B** $mgh - \frac{1}{2}mv^2$
- C** mgh
- D** $mgh + \frac{1}{2}mv^2$

10 Which energy resource does **not** derive its energy from the Sun?

- A geothermal
- B hydroelectric
- C oil
- D waves

11 Some processes are more efficient than others.

Which expression gives the efficiency of a process?

- A $\frac{\text{total energy output}}{\text{total energy input}} \times 100\%$
- B $\frac{\text{useful energy output}}{\text{total energy input}} \times 100\%$
- C $\frac{\text{wasted energy output}}{\text{total energy input}} \times 100\%$
- D $\frac{\text{wasted energy output}}{\text{useful energy output}} \times 100\%$

12 A diver under water uses breathing apparatus at a depth where the pressure is 1.25×10^5 Pa.

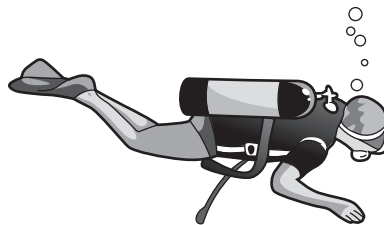

A bubble of gas breathed out by the diver has a volume of 20 cm^3 when it is released. The bubble moves upwards to the surface of the water.

At the surface of the water, the atmospheric pressure is 1.00×10^5 Pa.

The temperature of the water is the same at all depths.

What is the volume of this bubble when it reaches the surface?

- A 15 cm^3
- B 16 cm^3
- C 20 cm^3
- D 25 cm^3

13 The diagram shows a simple mercury barometer.

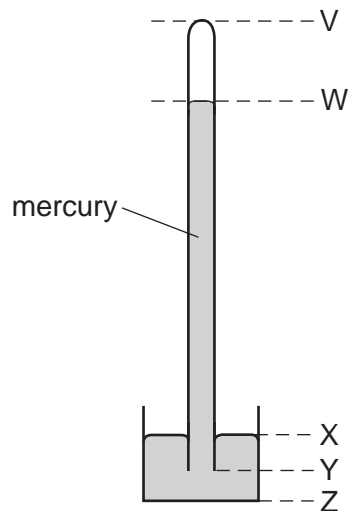

The atmospheric pressure increases.

Which distance increases?

- A** VW **B** WY **C** XY **D** XZ

14 Which statement describes what happens as ice at 0°C starts to melt to become water?

- A** Energy is absorbed and the temperature remains constant.
B Energy is absorbed and the temperature rises.
C Energy is released and the temperature remains constant.
D Energy is released and the temperature rises.

15 Smoke particles, illuminated by a bright light, are seen through a microscope. They move about randomly.

What causes this motion?

- A** attraction between the smoke particles and the molecules of the air
B collisions between the smoke particles and the molecules of the air
C evaporation of the faster-moving smoke particles
D warming of the smoke particles by the lamp

- 16 A liquid is at a temperature below its boiling point.

The liquid is then heated so that it becomes a gas at a temperature above its boiling point.

Which row correctly compares the liquid with the gas?

	average distance between the particles	average speed of the particles
A	greater in the liquid	greater in the liquid
B	greater in the liquid	smaller in the liquid
C	smaller in the liquid	greater in the liquid
D	smaller in the liquid	smaller in the liquid

- 17 A beaker of liquid is left on a laboratory bench. There is an electric fan in the laboratory causing a draught over the liquid.

The liquid evaporates.

Which row shows two changes that will **both** cause the liquid to evaporate more quickly?

	change to surface area of the liquid	change to speed of fan
A	decrease	decrease
B	decrease	increase
C	increase	decrease
D	increase	increase

- 18 Which processes occur in a metal to cause thermal conduction?

	electron transfer	proton transfer	lattice vibration
A	✓	✓	✓
B	✓	✓	✗
C	✓	✗	✓
D	✗	✓	✓

key

✓ = process occurs

✗ = process does not occur

- 19 A wooden beam is painted part black and part white. The beam absorbs infra-red radiation from the Sun during the day, and loses infra-red radiation to the surroundings at night.

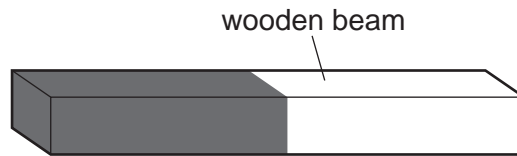

Which part of the beam heats up more quickly during the day, and which part cools down more quickly at night?

	part heating up more quickly	part cooling down more quickly
A	black	black
B	black	white
C	white	black
D	white	white

- 20 5.0g of water at 25 °C is dropped onto a large block of ice at 0 °C. The water cools to 0 °C and some of the ice melts.

Assume that all the energy lost by the water is gained by the ice.

What is the mass of ice that melts?

The specific heat capacity of water is 4.2 J/(g °C).

The specific latent heat of fusion of ice is 340 J/g.

- A** 0.062g **B** 0.087g **C** 1.5g **D** 10g

- 21 The frequency of a wave is doubled. The speed of the wave does not change.

What happens to the wavelength of the wave?

- A** It becomes four times as large.
B It does not change.
C It doubles.
D It halves.

22 Which row shows the natures of light waves, sound waves and X-rays?

	light waves	sound waves	X-rays
A	longitudinal	longitudinal	transverse
B	longitudinal	transverse	longitudinal
C	transverse	longitudinal	transverse
D	transverse	transverse	longitudinal

23 The diagram shows light passing from air into glass.

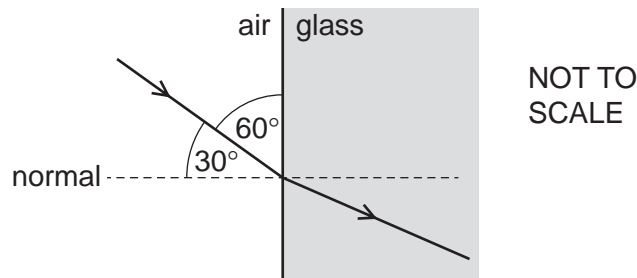

The glass has a refractive index of 1.5.

What is the angle of refraction in the glass?

- A** 19° **B** 22° **C** 35° **D** 49°

24 Visible light has a frequency of approximately 5.0×10^{14} Hz.

M and N are two other types of electromagnetic radiation.

The frequency of M is 5.0×10^6 Hz.

The frequency of N is 5.0×10^{15} Hz.

Which types of radiation are M and N?

	M	N
A	radio waves	infra-red
B	radio waves	ultraviolet
C	ultraviolet	X-rays
D	X-rays	infra-red

- 25 The diagram shows a converging lens forming an image of an object.

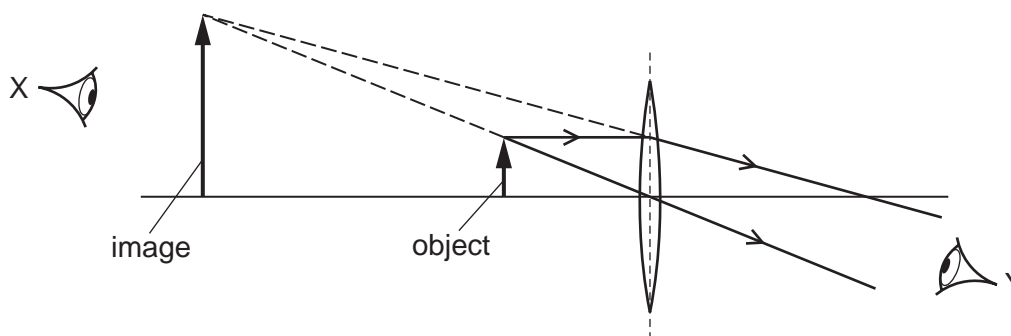

Which statement about the image is correct?

- A** It is real and can be seen by an eye at X.
B It is real and can be seen by an eye at Y.
C It is virtual and can be seen by an eye at X.
D It is virtual and can be seen by an eye at Y.
- 26 A small potential difference V is applied across a filament lamp. The current I in the lamp is measured. V is increased in stages and I is measured at each stage.

Which graph shows the results obtained?

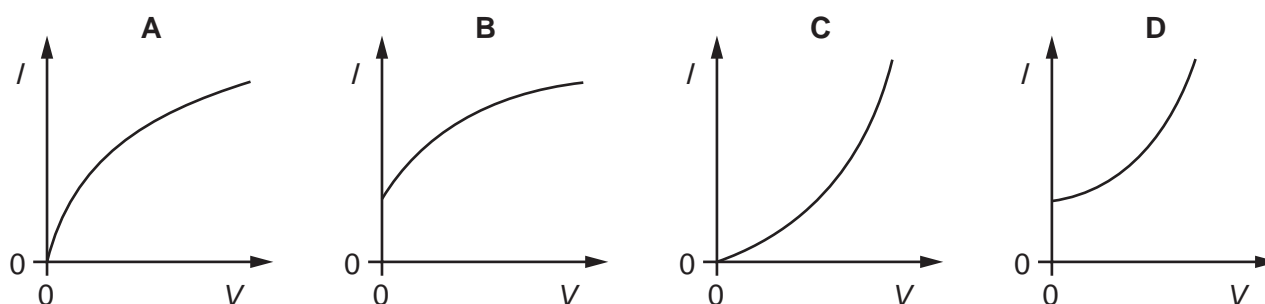

- 27 A resistor of resistance R is connected to a battery of e.m.f. V .

There is a current I in the resistor.

Power P is dissipated by the resistor, and in time t the energy transferred is E .

Which expression is correct?

- A** $E = IVt$ **B** $E = Pit$ **C** $P = VIR$ **D** $P = \frac{V}{R}$

28 A wire has a certain electrical resistance.

The diameter and length of the wire may be changed.

Which pair of changes **must** cause the resistance of the wire to increase?

	change of diameter	change of length
A	decrease	decrease
B	decrease	increase
C	increase	decrease
D	increase	increase

29 The four circuits shown all include an a.c. power supply, two diodes and a lamp.

In which circuit is there a rectified current in the lamp?

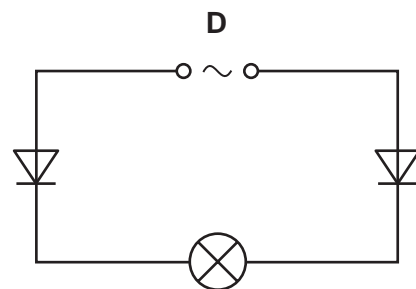
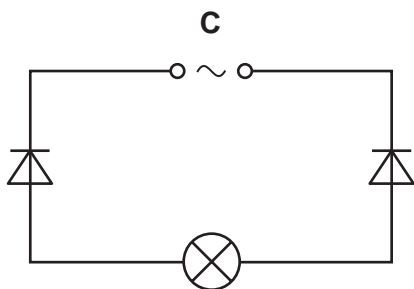
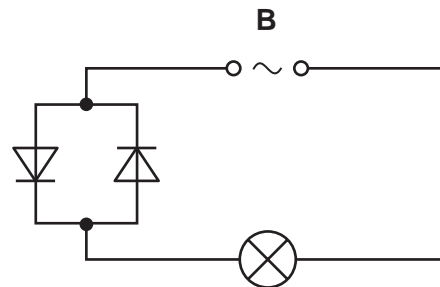
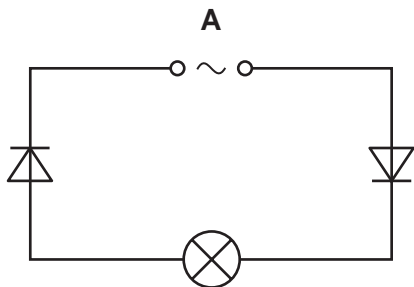

30 P and Q are the circuit symbols for two electrical components.



Which components are represented by P and by Q?

	P	Q
A	thermistor	fuse
B	thermistor	relay
C	variable resistor	fuse
D	variable resistor	relay

31 The diagram shows a combination of logic gates.

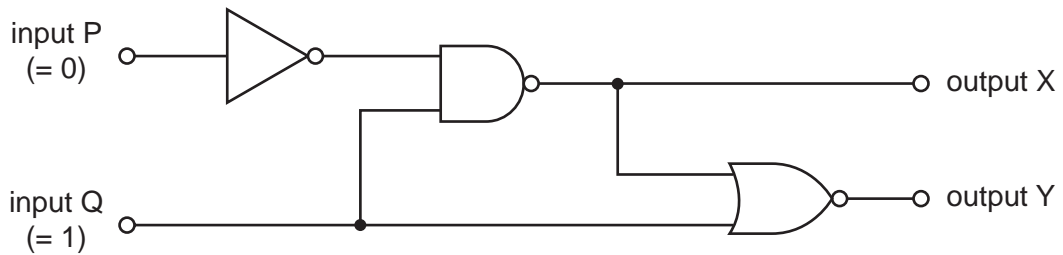

Input P is at a logic state 0 (low) and input Q is at a logic state 1 (high).

What are the logic states at output X and at output Y?

	output X	output Y
A	0	0
B	0	1
C	1	0
D	1	1

32 The diagram shows part of a circuit used to switch street lamps on and off automatically.

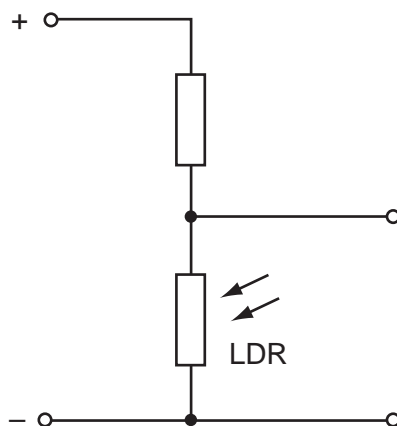

In the evening it gets dark.

Which row shows the effect on the resistance of the light-dependent resistor (LDR) and on the potential difference (p.d.) across it?

	resistance of LDR	p.d. across LDR
A	decreases	decreases
B	decreases	increases
C	increases	decreases
D	increases	increases

33 A domestic circuit includes a 30 A fuse. This protects the wiring if there is too much current in the circuit.

In which wire is the 30 A fuse positioned, and what does it do when it operates?

	position	operation
A	live wire	disconnects the circuit
B	live wire	reduces the current to 30 A
C	neutral wire	disconnects the circuit
D	neutral wire	reduces the current to 30 A

34 A strong electromagnet is used to attract pins.

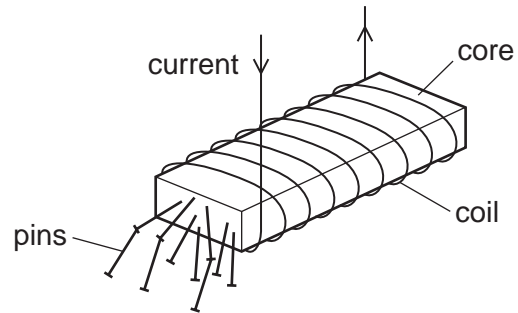

What happens when the current in the coil is halved?

- A No pins are attracted.
- B Some pins are attracted, but not as many.
- C The same number of pins is attracted.
- D More pins are attracted.

35 The diagram shows a transformer.

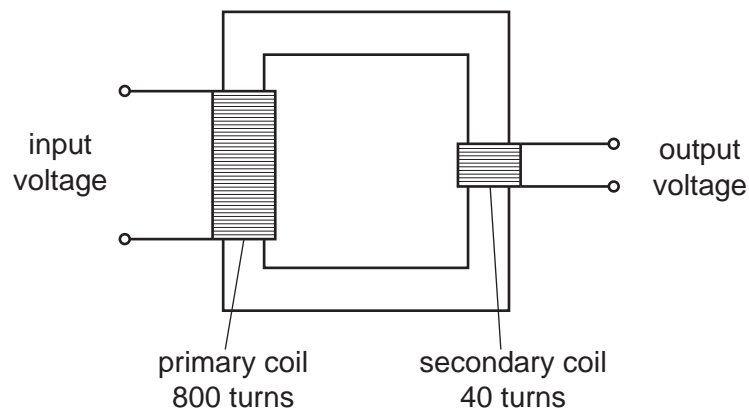

The input voltage is 240V.

What is the output voltage?

- A 6.0V
- B 12V
- C 20V
- D 40V

36 The diagram shows a shaded area where the direction of a magnetic field is into the page.

A beam of β -particles enters the field as shown.

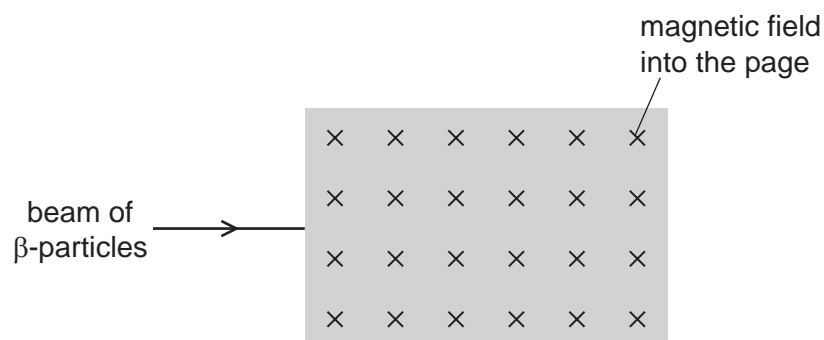

In which direction is the beam of β -particles deflected as they enter the magnetic field?

- A into the page
- B out of the page
- C down the page
- D up the page

37 A very important experiment increased scientists' understanding of the structure of matter.

In the experiment, particles scattered as they passed through a thin metal foil.

Which particles were used, and to which conclusion did the experiment lead?

	particles	conclusion
A	alpha particles	matter is made up of atoms
B	alpha particles	atoms have a very small nucleus
C	beta particles	matter is made up of atoms
D	beta particles	atoms have a very small nucleus

38 Below are the symbols for five different nuclides.

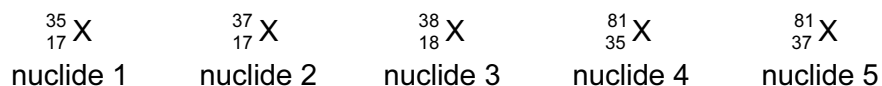

Which two nuclides are isotopes of the same element?

- A nuclide 1 and nuclide 2
- B nuclide 2 and nuclide 3
- C nuclide 2 and nuclide 5
- D nuclide 4 and nuclide 5

39 A radioactive decay can be represented as shown.

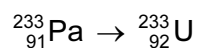

The equation is incomplete.

In this decay, the nucleus changes by

- A absorbing a neutron.
- B absorbing a proton.
- C emitting an α -particle.
- D emitting a β -particle.

40 The graph shows how the decay rate of a radioactive source changes with time.

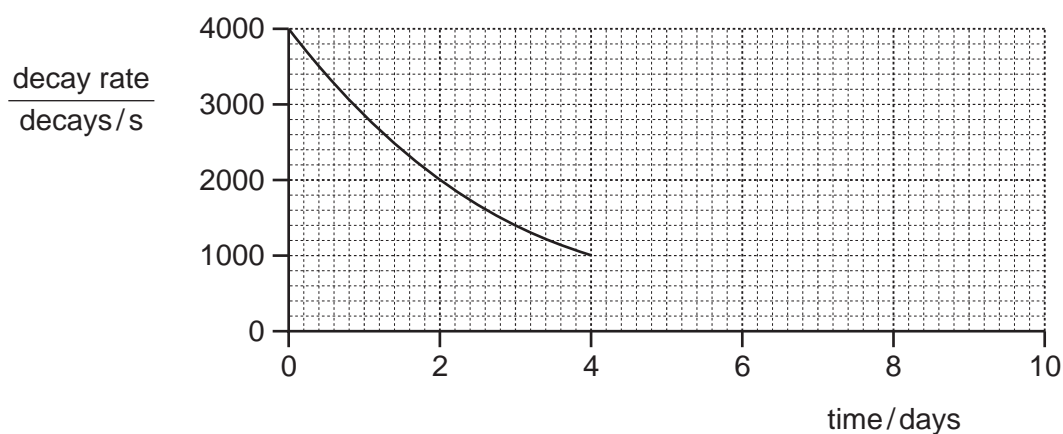

What will be the decay rate at 8 days?

- A 0 decays/s
- B 125 decays/s
- C 250 decays/s
- D 500 decays/s

Permission to reproduce items where third-party owned material protected by copyright is included has been sought and cleared where possible. Every reasonable effort has been made by the publisher (UCLES) to trace copyright holders, but if any items requiring clearance have unwittingly been included, the publisher will be pleased to make amends at the earliest possible opportunity.

To avoid the issue of disclosure of answer-related information to candidates, all copyright acknowledgements are reproduced online in the Cambridge International Examinations Copyright Acknowledgements Booklet. This is produced for each series of examinations and is freely available to download at www.cie.org.uk after the live examination series.

Cambridge International Examinations is part of the Cambridge Assessment Group. Cambridge Assessment is the brand name of University of Cambridge Local Examinations Syndicate (UCLES), which is itself a department of the University of Cambridge.