

CANDIDATE  
NAME

CENTRE  
NUMBER

--	--	--	--	--

CANDIDATE  
NUMBER

--	--	--	--

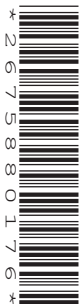

**PHYSICS**

**0625/22**

Paper 2 Core

**February/March 2015**

**1 hour 15 minutes**

Candidates answer on the Question Paper.

No Additional Materials are required.

**READ THESE INSTRUCTIONS FIRST**

Write your Centre number, candidate number and name on all the work you hand in.

Write in dark blue or black pen.

You may use an HB pencil for any diagrams or graphs.

Do not use staples, paper clips, glue or correction fluid.

**DO NOT WRITE IN ANY BARCODES.**

Answer **all** questions.

Electronic calculators may be used.

You may lose marks if you do not show your working or if you do not use appropriate units.

Take the weight of 1 kg to be 10 N (i.e. acceleration of free fall =  $10 \text{ m/s}^2$ ).

At the end of the examination, fasten all your work securely together.

The number of marks is given in brackets [ ] at the end of each question or part question.

1 A coconut falls from position X to position Y, as shown in Fig. 1.1.

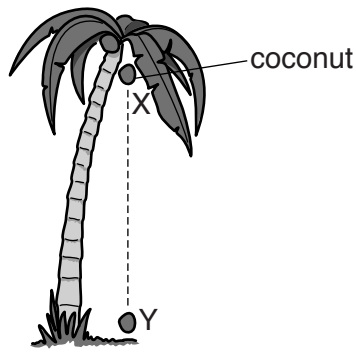

Fig. 1.1

(a) State what causes the coconut to accelerate.

.....[1]

(b) Compare the acceleration at positions X and Y. Tick one box.

- much greater at X than at Y
- much greater at Y than at X
- about the same at X as at Y [1]

(c) Using the axes in Fig. 1.2, sketch the graph showing how the speed of the coconut changes as it falls from X to Y. [2]



Fig. 1.2

(d) State how the distance XY is determined from your graph in (c).

.....[1]

[Total: 5]

2 Fig. 2.1 shows a spring before and after it is stretched by a small load.

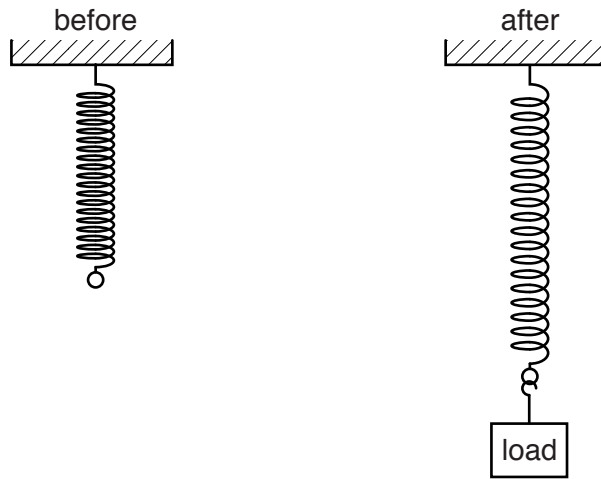

**Fig. 2.1**

(a) On Fig. 2.1,

- (i) mark the extension caused by the load,
- (ii) draw the apparatus needed to determine the extension.

[2]

(b) Fig. 2.2 shows a sketch graph of the length of the spring, plotted against the weight of the load.

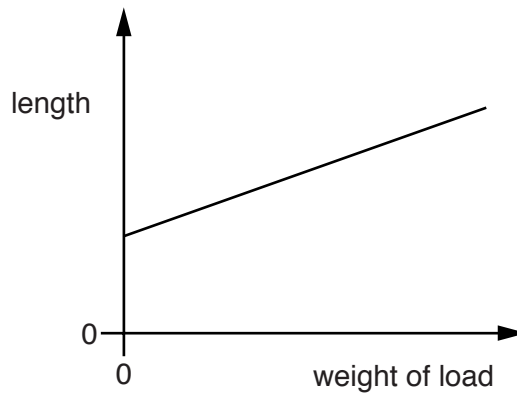

**Fig. 2.2**

On Fig. 2.2, mark clearly the unstretched length of the spring.

[1]

(c) State the unit in which the weight of the load is measured.

.....[1]

[Total: 4]

- 3 (a) A microphone is a device designed to convert an input of sound energy into an output of electrical energy.

Complete the table below. In each case, give the name of a device that is designed to give the stated energy output with the stated energy input.

energy input	useful energy output	device
sound	electrical	microphone
electrical	sound	
chemical	electrical	
electrical	thermal	
electrical	kinetic	

[4]

- (b) The electrical energy output from the microphone is less than the sound energy input.

- (i) State the principle of conservation of energy.

.....  
 .....[1]

- (ii) Explain how this principle applies to the microphone.

.....  
 .....[2]

[Total: 7]

4 Fig. 4.1 is a ray diagram representing two rays passing through a converging lens.

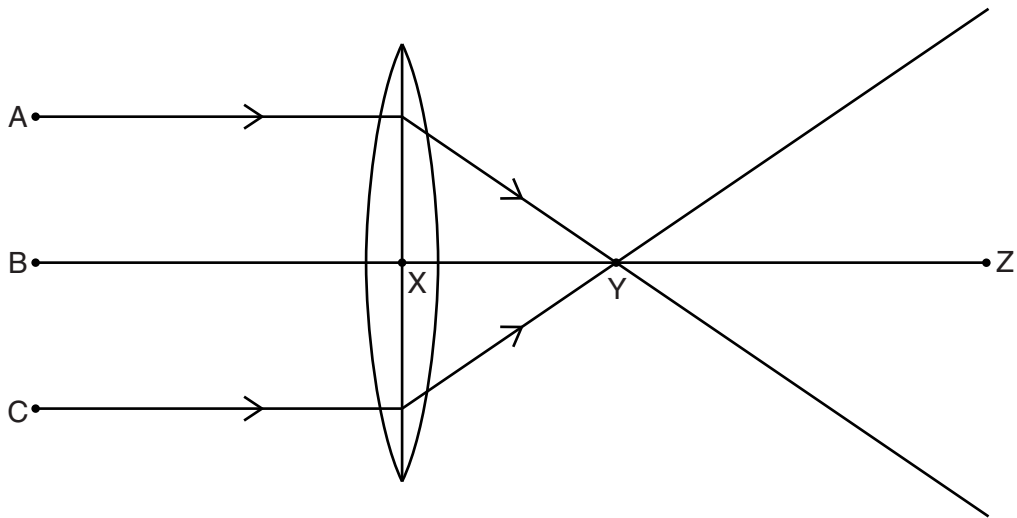

**Fig. 4.1**

- (a) State which of the labelled points is a principal focus of the lens. .... [1]
- (b) State which of the distances BX, XY, YZ or XZ is the focal length of the lens. .... [1]
- (c) On Fig. 4.1, draw another ray from point A to locate the image of point A. Label this image I. [3]
- (d) On the ray diagram in Fig. 4.1, the refraction is shown occurring at the centre line of the lens. State where the refraction actually occurs.

.....  
 .....[1]

[Total: 6]

- 5 (a) A ray of light in glass meets a boundary with air.

In Fig. 5.1, the three diagrams X, Y and Z each show a different angle of incidence for the ray.

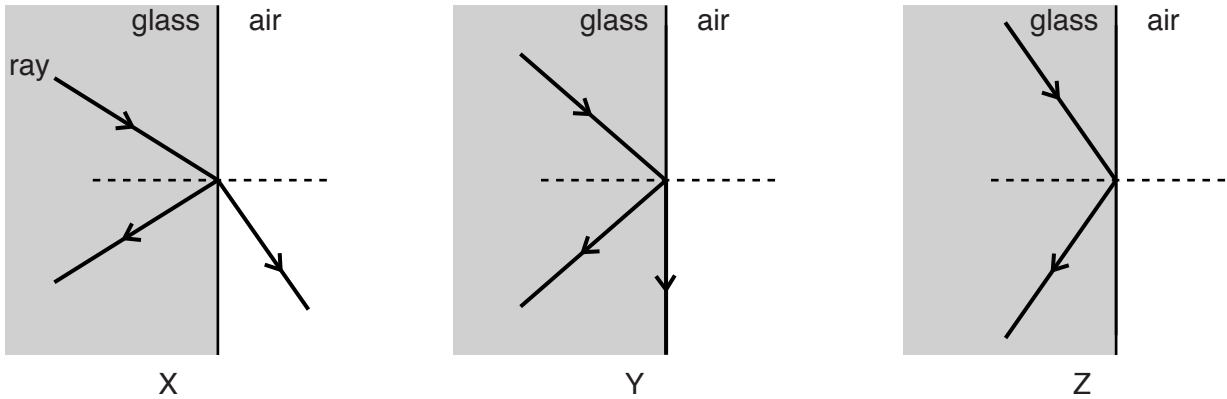

Fig. 5.1

- (i) Write down the letter of any diagram, X, Y or Z, in which the ray undergoes

1. refraction, .....
2. total internal reflection. ....

[2]

- (ii) On Fig. 5.1, use the letter C to mark the critical angle for light at the glass-air boundary. [1]

- (b) Water waves move more slowly in shallow water than in deep water.

Fig. 5.2 shows wavefronts of a wave in deep water meeting the boundary with some shallow water.

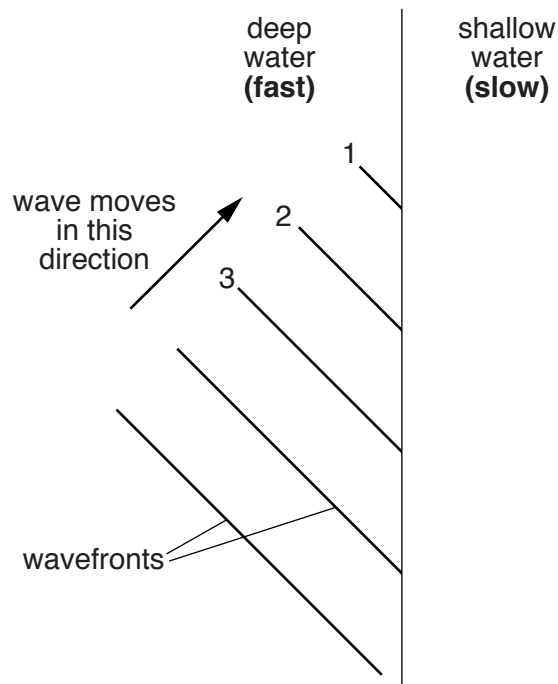

Fig. 5.2

- (i) Using your ruler, carefully complete the wavefronts 1, 2 and 3, showing their possible positions in the shallow water where they move more slowly. [3]
- (ii) Tick the **one** box that describes what is happening at the boundary.

- diffraction
- echo
- refraction
- total internal reflection

[1]

[Total: 7]

- 6 Two students A and B are carrying out an experiment to determine the speed of sound.

They are standing side by side at a distance of 480 m from the school wall, as shown in Fig. 6.1.

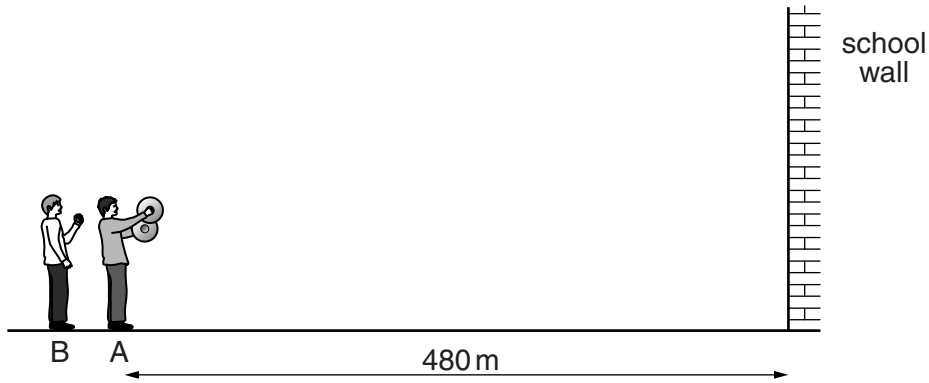

**Fig. 6.1** (not to scale)

Student A makes a loud sound by banging two pan lids together once. A short time later, both students hear the sound again.

- (a) State what causes this second sound.

.....[1]

- (b) Underline the phrases that correctly complete the sentences below.

The second sound is  $\left\{ \begin{array}{l} \text{louder than} \\ \text{equally as loud as} \\ \text{quieter than} \end{array} \right\}$  the original sound.

This is because the  $\left\{ \begin{array}{l} \text{amplitude} \\ \text{frequency} \\ \text{speed} \\ \text{wavelength} \end{array} \right\}$  of the sound has  $\left\{ \begin{array}{l} \text{changed.} \\ \text{not changed.} \end{array} \right\}$

[2]



(c) The time between the two sounds, as measured by student B, is 3.0s.

(i) Suggest the instrument that student B used to measure the time.

.....[1]

(ii) Use the measurements to calculate the speed of sound.

speed = ..... m/s [3]

[Total: 7]

- 7 The electric circuit in Fig. 7.1 consists of a battery, two lamps and a switch. A voltmeter is connected across one of the lamps.

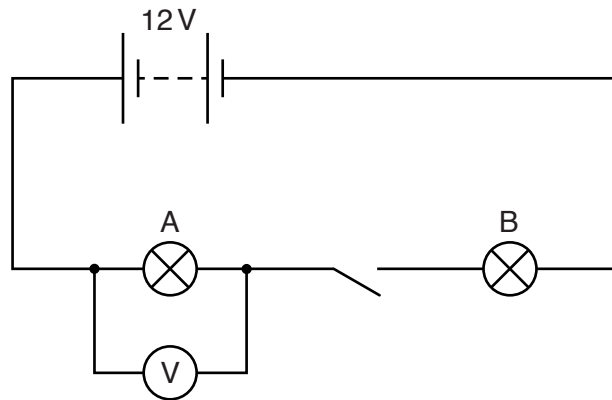

Fig. 7.1

- (a) Which quantity does the voltmeter measure? Tick one box.

- charge
- current
- potential difference
- power

[1]

- (b) The switch is closed so that there is a current in the lamps.

- (i) What flows in the circuit in order to create the current? Tick one box.

- charge
- potential difference
- power
- resistance

[1]

(ii) The resistance of each lamp is  $18\Omega$ .

Calculate

1. the combined resistance of the lamps,

combined resistance = .....  $\Omega$  [1]

2. the current in the circuit, stating the unit in your answer.

current = ..... [4]

(iii) Calculate the value of the reading on the voltmeter.

voltmeter reading = ..... V [2]

(c) Suggest one disadvantage of connecting lamps in series rather than in parallel.

.....  
..... [1]

[Total: 10]

8 (a) When materials are heated, they usually expand.

Describe one example where

(i) the expansion is useful,

.....  
.....  
.....[2]

(ii) the expansion causes problems that need to be allowed for.

.....  
.....  
.....[2]

(b) State two things that happen to the molecules of a solid when it is cooled.

- 1. ....
  - 2. ....
- [2]

(c) Fig. 8.1 shows some balloons that have been filled with gas and tied to a heavy box.

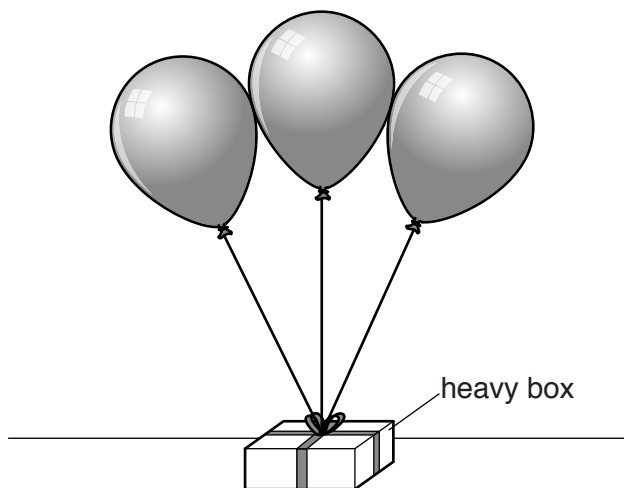

Fig. 8.1

(i) In the sunlight, the gas in the balloons gets warmer.

State what is seen to happen to the balloons.

.....[1]

(ii) In terms of molecules, explain your answer to (c)(i).

.....  
.....  
.....[3]

[Total: 10]

9 Fig. 9.1 shows a simple motor.

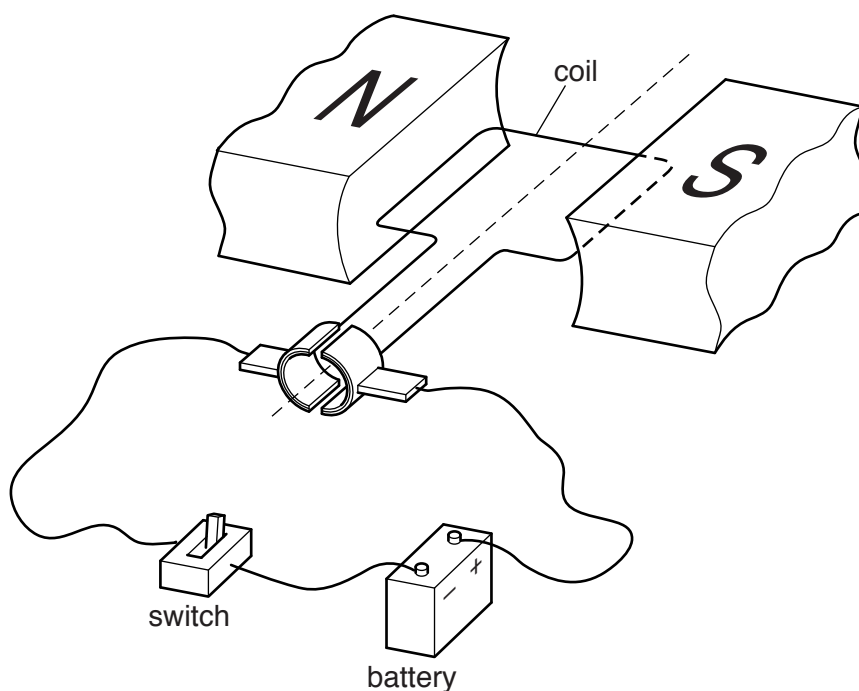

**Fig. 9.1**

(a) The switch is closed.

Explain why the coil starts to rotate.

.....

.....

.....

.....

.....

.....

.....

.....

.....

.....[4]

(b) Suggest **one** way of making the coil rotate faster.

.....

.....[1]

[Total: 5]

10 (a) Complete the three sentences below, to describe attraction and repulsion in electrostatics.

Two positive charges .....

Two negative charges .....

A positive charge and a negative charge .....

A positive charge and an uncharged conductor .....

[3]

(b) A charged plastic sphere is hanging on an insulating thread.

When a negatively-charged rod is brought near, the sphere and thread move to the position shown in Fig. 10.1.

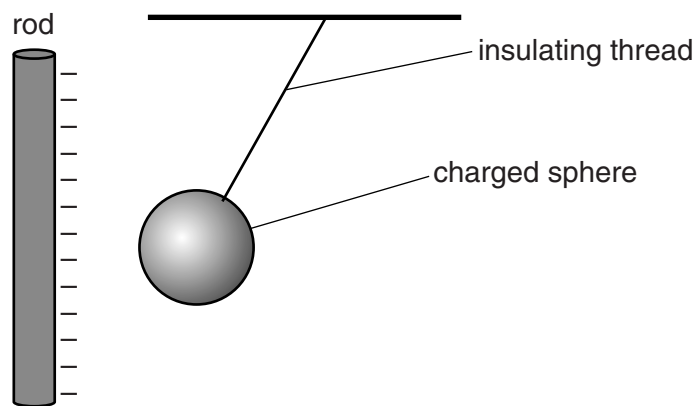

Fig. 10.1

(i) State the sign of the charge on the sphere.

.....[1]

(ii) Describe what happens to the sphere and thread when the rod is moved far away from them.

.....

.....[1]

(c) State the name of a material that is an electrical conductor.

.....[1]

[Total: 6]

11 Fig. 11.1 shows how the count rate from a radioactive source varies with time.

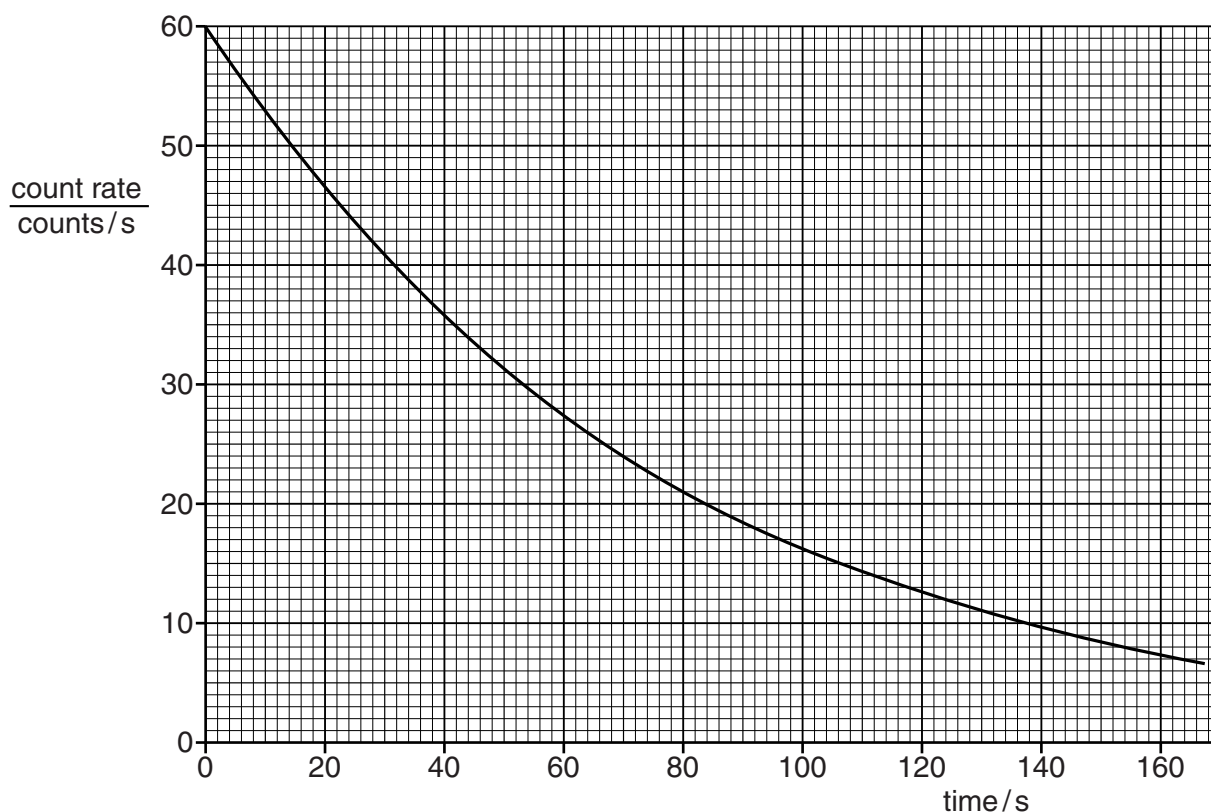

Fig. 11.1

(a) Using Fig. 11.1, describe how the count rate changes with time.

.....  
 ..... [2]

(b) (i) Using Fig. 11.1, determine how many seconds it takes for the count rate to change from 60 counts/s to 15 counts/s.

number of seconds = ..... [1]

(ii) State the number of half-lives in this time.

number of half-lives = ..... [1]

(c) Calculate the half-life of the radioactive substance.

half-life = ..... s [2]



(d) State the time taken for the count rate to change from 10 counts/s to 5 counts/s.

time = .....s [1]

[Total: 7]

**Question 12 is on the next page.**

12 Fig. 12.1 represents a simple model of an atom.

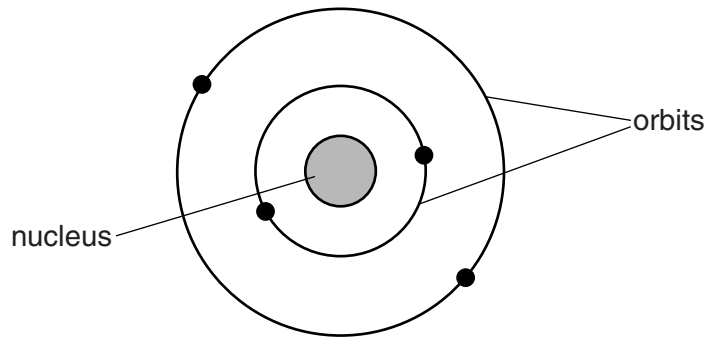

Fig. 12.1

The atom is composed of electrons, protons and neutrons.

(a) Where in the atom are

- (i) the electrons, .....
- (ii) the protons, .....
- (iii) the neutrons? .....

[3]

(b) Which of these particles, electrons, protons or neutrons, have

- (i) a positive charge, .....
- (ii) a negative charge, .....
- (iii) zero charge? .....

[2]

(c) Complete the following sentence.

In every neutral atom, the number of ..... is equal to the number of .....

[1]

[Total: 6]



**BLANK PAGE**

---

Permission to reproduce items where third-party owned material protected by copyright is included has been sought and cleared where possible. Every reasonable effort has been made by the publisher (UCLES) to trace copyright holders, but if any items requiring clearance have unwittingly been included, the publisher will be pleased to make amends at the earliest possible opportunity.

To avoid the issue of disclosure of answer-related information to candidates, all copyright acknowledgements are reproduced online in the Cambridge International Examinations Copyright Acknowledgements Booklet. This is produced for each series of examinations and is freely available to download at [www.cie.org.uk](http://www.cie.org.uk) after the live examination series.

Cambridge International Examinations is part of the Cambridge Assessment Group. Cambridge Assessment is the brand name of University of Cambridge Local Examinations Syndicate (UCLES), which is itself a department of the University of Cambridge.