



**Cambridge International Examinations**  
Cambridge International General Certificate of Secondary Education

**PHYSICS**

**0625/13**

Paper 1 Multiple Choice

**October/November 2014**

**45 minutes**

Additional Materials: Multiple Choice Answer Sheet  
Soft clean eraser  
Soft pencil (type B or HB recommended)



**READ THESE INSTRUCTIONS FIRST**

Write in soft pencil.  
Do not use staples, paper clips, glue or correction fluid.  
Write your name, Centre number and candidate number on the Answer Sheet in the spaces provided unless this has been done for you.  
**DO NOT WRITE IN ANY BARCODES.**

There are **forty** questions on this paper. Answer **all** questions. For each question there are four possible answers **A, B, C** and **D**.  
Choose the **one** you consider correct and record your choice in **soft pencil** on the separate Answer Sheet.

**Read the instructions on the Answer Sheet very carefully.**

Each correct answer will score one mark. A mark will not be deducted for a wrong answer.  
Any rough working should be done in this booklet.  
Electronic calculators may be used.

bestexamhelp.com

The syllabus is approved for use in England, Wales and Northern Ireland as a Cambridge International Level 1/Level 2 Certificate.

This document consists of **18** printed pages and **2** blank pages.

- 1 A stopwatch is used to time a runner in a race. The diagrams show the stopwatch at the start and at the end of a lap of the race.



start of lap



end of lap

How long did the runner take to finish the lap of the race?

- A 50.00 seconds
  - B 50.10 seconds
  - C 90.00 seconds
  - D 100.10 seconds
- 2 The graph shows how the speed of a car changes with time.

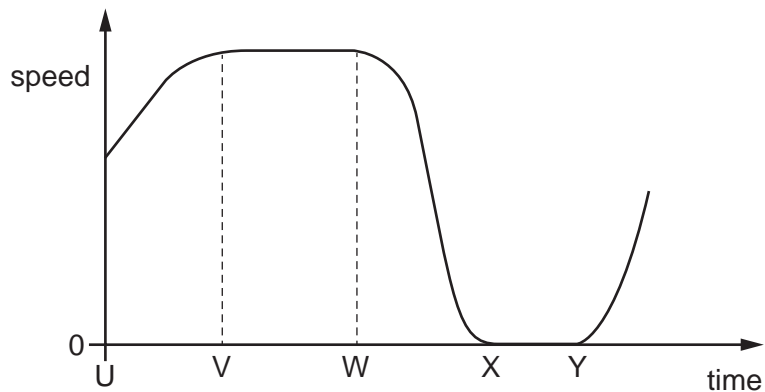

Between which two times is the car stationary?

- A U and V
- B V and W
- C W and X
- D X and Y

- 3 An aeroplane flies from town **X** to town **Z**, stopping for 1 hour at town **Y** to pick up more passengers. The distances between the towns are shown in the diagram.

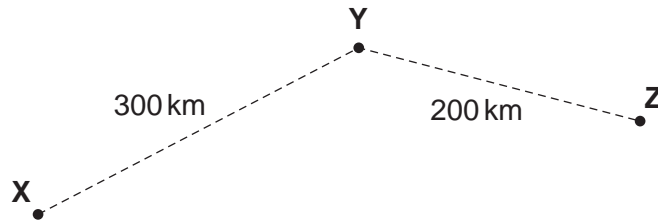

The total time taken between leaving **X** and arriving at **Z** is 3 hours.

What is the average speed of the aeroplane **in the air**?

- A  $\frac{500}{4}$  km/h    B  $\frac{500}{3}$  km/h    C  $\frac{500}{2}$  km/h    D  $\frac{500}{1}$  km/h
- 4 The mass of an astronaut is 70 kg on the Moon.  
What is the mass of the astronaut on the Earth?
- A 7 kg    B 70 kg    C 80 kg    D 700 kg
- 5 The weight of an object is found using the balance shown in the diagram. The object is put in the left-hand pan and various weights are put in the right-hand pan.

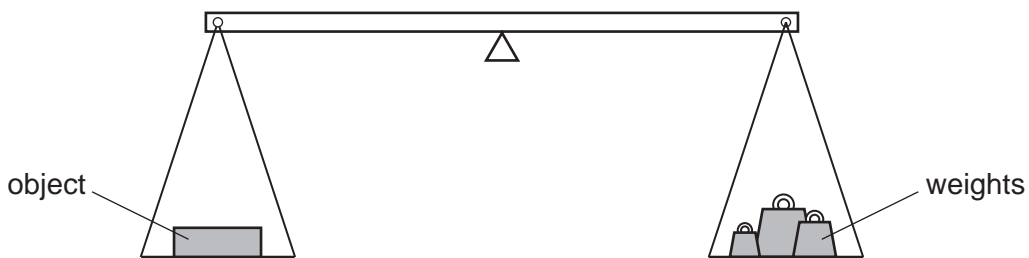

These are the results.

weights in the right-hand pan	effect
0.1 N, 0.1 N, 0.05 N, 0.02 N	balance tips down slightly on the left-hand side
0.2 N, 0.1 N, 0.01 N	balance tips down slightly on the right-hand side

What is the best estimate of the weight of the object?

- A 0.27 N    B 0.29 N    C 0.31 N    D 0.58 N

6 Diagram 1 shows an empty measuring cylinder on a balance.

Diagram 2 shows the same measuring cylinder on the balance, but it now contains a liquid.

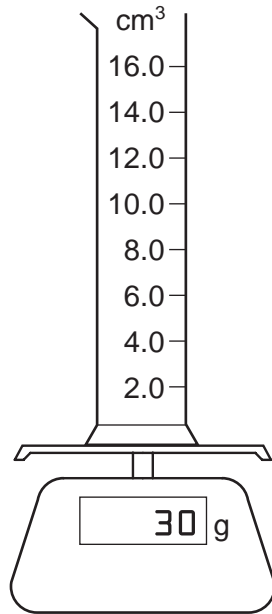

diagram 1

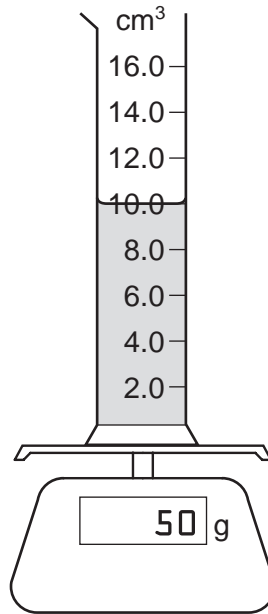

diagram 2

What is the density of the liquid?

- A**  $0.2\text{ g/cm}^3$     **B**  $0.5\text{ g/cm}^3$     **C**  $2.0\text{ g/cm}^3$     **D**  $5.0\text{ g/cm}^3$

7 In which situation is **no** resultant force needed?

- A** a car changing direction at a steady speed  
**B** a car moving in a straight line at a steady speed  
**C** a car slowing down  
**D** a car speeding up

- 8 The diagram shows a uniform, flat metal sheet hanging freely from a nail at point **A**. A weight also hangs freely on a string tied to **A**.

One of the labelled points is at the centre of mass of the metal sheet.

Which point is at the centre of mass?

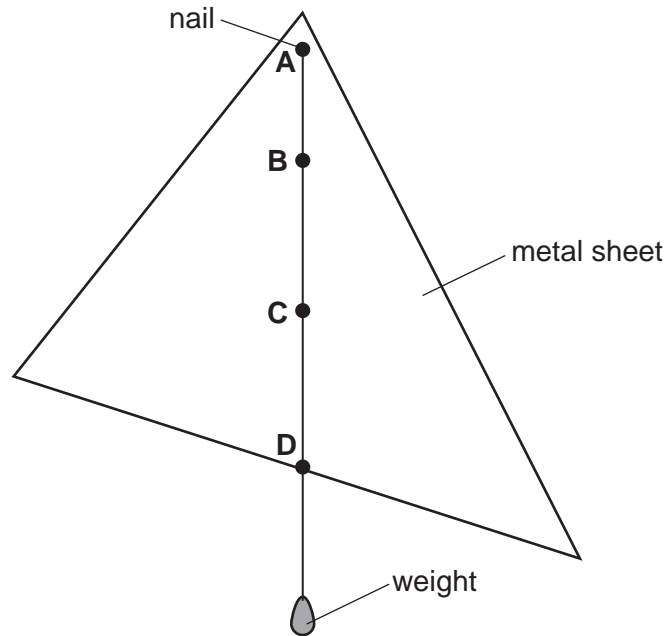

- 9 When a bicycle lamp is switched on, what is the useful energy change **within the battery**?

- A chemical energy to electrical energy
- B electrical energy to chemical energy
- C electrical energy to light energy
- D light energy to chemical energy

- 10 A student does some work by pulling a suitcase along a corridor.

She now pulls a second suitcase along the corridor.

Which row indicates that the student is now doing twice as much work?

	the force used to pull suitcase	the distance the suitcase is pulled
<b>A</b>	is doubled	is doubled
<b>B</b>	is doubled	is halved
<b>C</b>	stays the same	is doubled
<b>D</b>	stays the same	is halved

- 11 The scale diagram shows three identical blocks, P, Q and R. The blocks have different areas of contact with the ground.

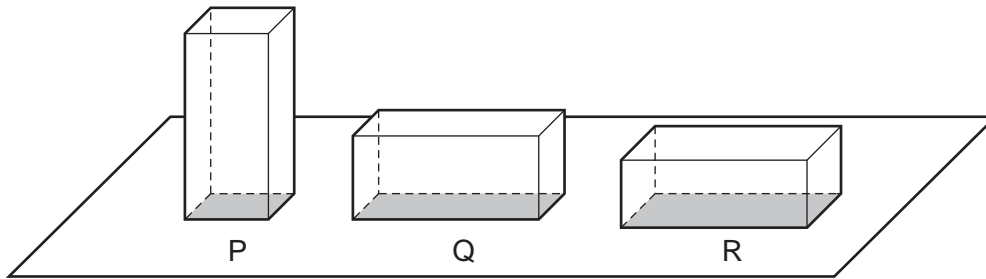

Which block exerts the greatest pressure on the ground?

- A block P
  - B block Q
  - C block R
  - D they all exert the same pressure
- 12 A manometer is used to measure the pressure of the air in a container.

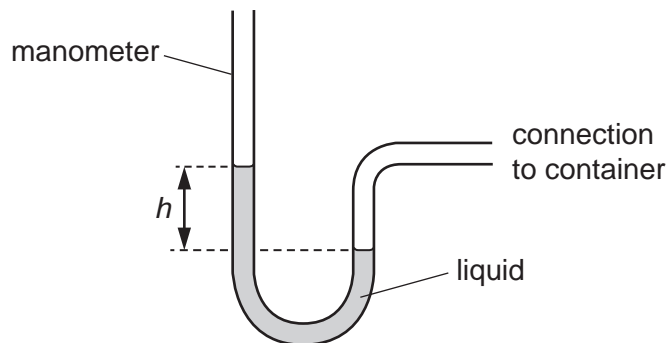

Which change would give a bigger value of height  $h$ ?

- A using a less dense liquid
- B using a more dense liquid
- C using a narrower tube
- D using a wider tube

- 13 The volume of a gas in a sealed syringe is increased. The temperature of the gas does not change.

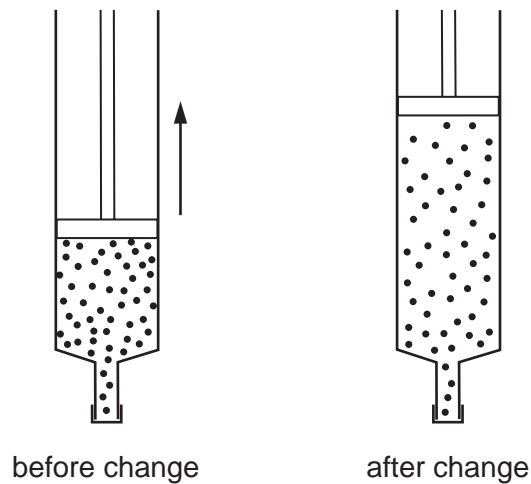

After this change is made, what has happened to the gas molecules in the syringe?

- A They move more quickly.
  - B They move more slowly.
  - C They hit the syringe walls less often.
  - D They hit the syringe walls more often.
- 14 Some liquid is poured into a metal dish on a wooden table. The dish, the liquid, the table and the air around the dish are all at the same temperature.

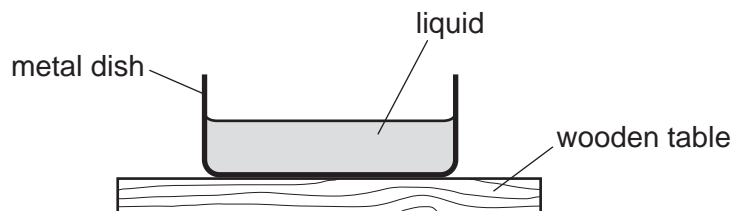

The temperature of the liquid now starts to decrease.

What could cause this temperature decrease?

- A convection currents in the liquid
- B conduction of heat through the metal dish
- C evaporation of the liquid
- D heat radiation from the liquid

15 The diagram shows four labelled changes of state between solid, liquid and gas.

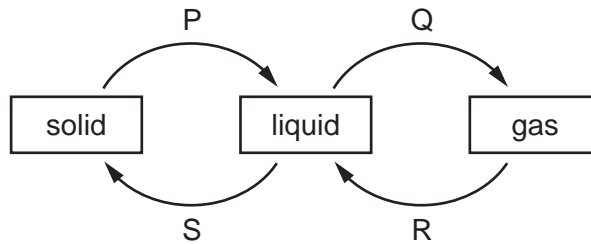

Which changes need an energy input?

- A** P and Q      **B** Q and R      **C** R and S      **D** S and P

16 Equal masses of two different liquids are put into identical beakers.

Liquid 1 is heated for 100 s and liquid 2 is heated for 200 s by heaters of the same power.

The temperature of both liquids increases by the same amount.

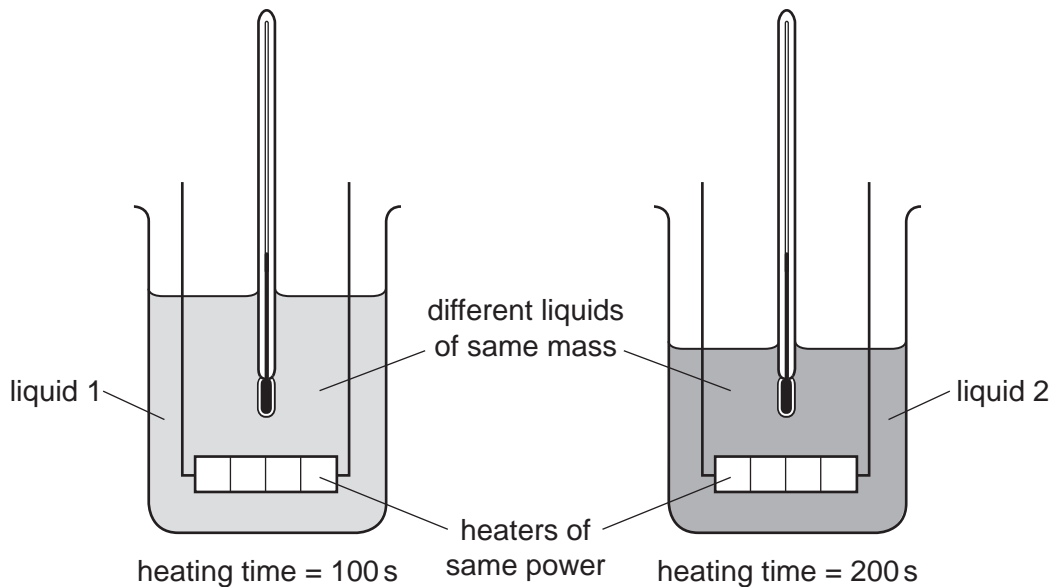

Which statement is correct?

- A** Both liquids receive the same amount of energy.  
**B** Liquid 1 receives more energy than liquid 2.  
**C** Both liquids have equal thermal capacity.  
**D** The thermal capacity of liquid 1 is less than the thermal capacity of liquid 2.



17 Two methods by which thermal energy can be transferred are conduction and radiation.

Which statement is correct?

- A Conduction involves density changes in fluids.
- B Conduction only occurs in solids.
- C Radiation cannot occur in a vacuum.
- D Radiation involves electromagnetic waves.

18 A heater is to be fitted in a room to warm the air throughout the room.

The diagram shows two possible positions to fit the heater, P and Q.

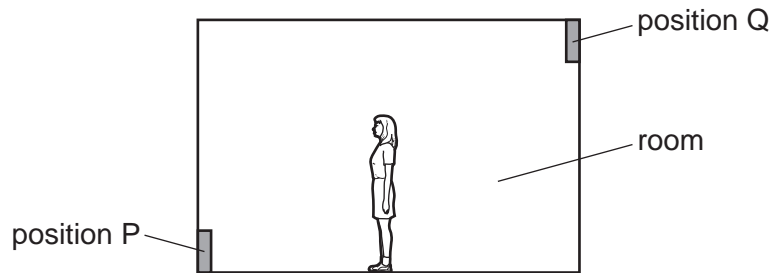

Which position is better and why?

	position	why?
<b>A</b>	P	warmer air is less dense and rises
<b>B</b>	P	warmer air is more dense and rises
<b>C</b>	Q	warmer air is less dense and falls
<b>D</b>	Q	warmer air is more dense and falls

19 The diagram shows four waves drawn to the same scale.

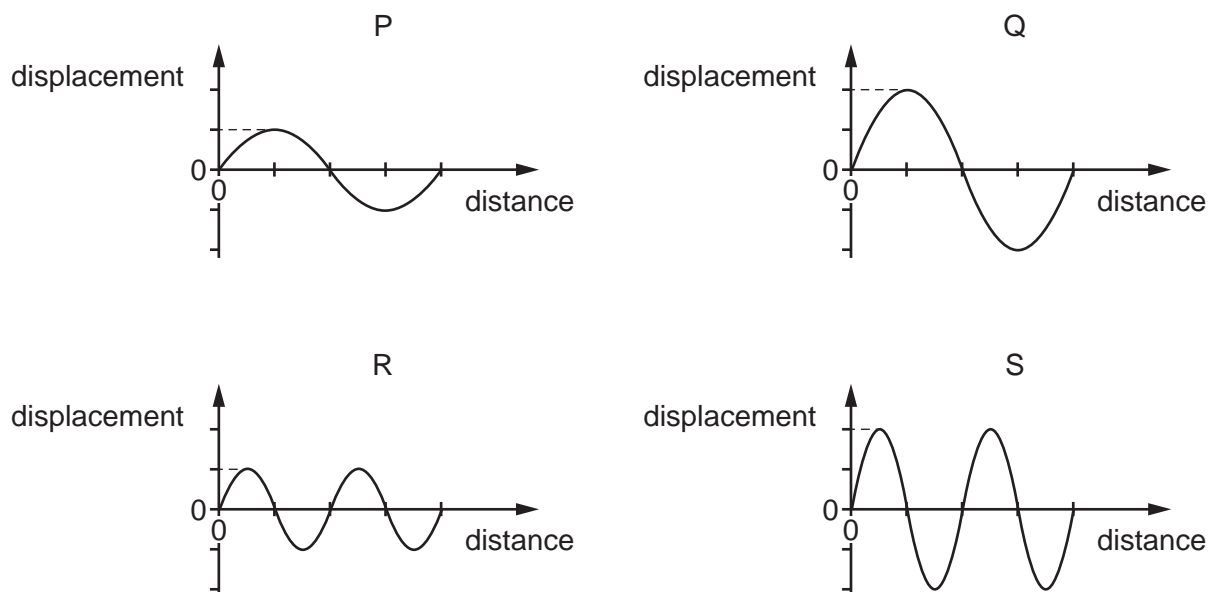

Which statement is correct?

- A The amplitude of wave P is the same as the amplitude of wave R.
- B The amplitude of wave S is double the amplitude of wave Q.
- C The wavelength of wave Q is double the wavelength of wave P.
- D The wavelength of wave S is the same as the wavelength of wave Q.

20 Waves travel more quickly on the surface of water when the water is deep.

A stone is dropped at point X into a pool of varying depth. The diagram shows the first wavefront on the surface of the pool.

The region between X and which labelled point is likely to be the deepest?

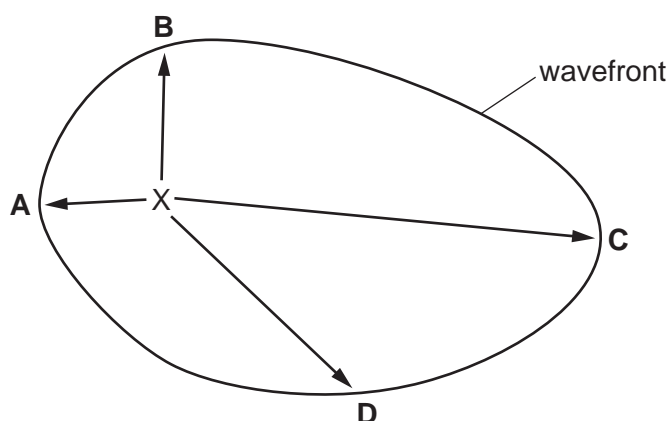

21 An intruder alarm sensor detects that a human is warmer than his surroundings.

Which type of electromagnetic wave does the sensor detect?

- A infra-red
- B radio
- C ultraviolet
- D visible light

22 Which waves are longitudinal?

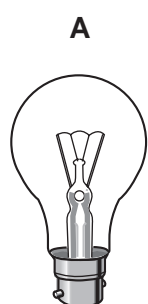

light waves  
from a lamp

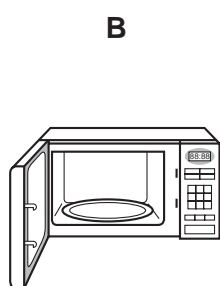

microwaves  
in an oven

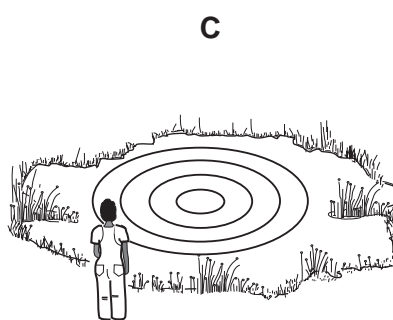

water waves  
on a pond



sound waves  
from a trumpet

23 An object is placed in front of a converging lens. The lens has a focal length  $f$ .

In which labelled position should the object be placed in order to produce a real image of the object that is smaller than the object?

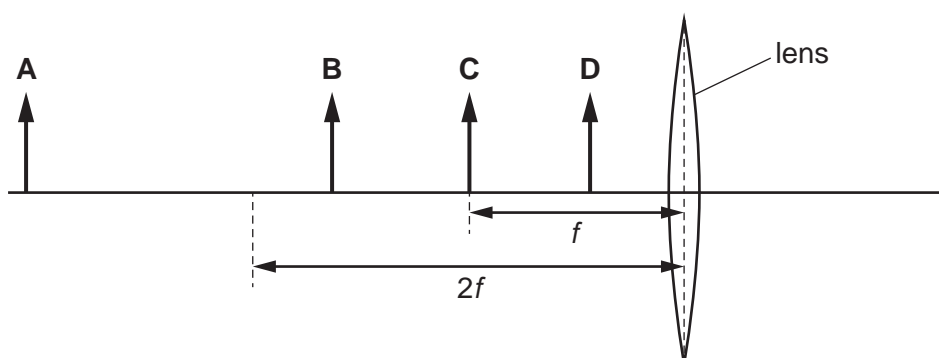

24 Three vibrating objects P, Q and R produce waves in the air of different frequencies as shown.

object	frequency / Hz
P	25
Q	1000
R	15 000

Which of these waves can be heard by a human ear?

- A P, Q and R
- B P and Q only
- C P and R only
- D Q and R only

25 In an experiment to measure the speed of sound, a student uses a stopwatch to find the time taken for a sound wave to travel from X to Y. She does this six times.

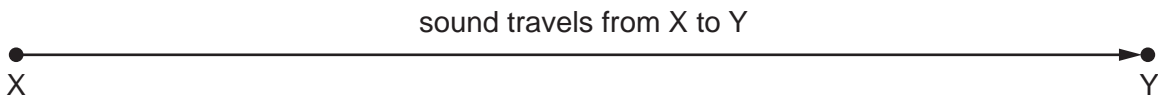

The table shows her results.

measurement	time / s
first	0.5
second	0.7
third	0.6
fourth	0.4
fifth	0.9
sixth	0.5

Which value for the time should be used to calculate the speed of sound?

- A 0.4 s
- B 0.5 s
- C 0.6 s
- D 0.9 s

- 26 The ends of three metal rods are tested by holding end Q of rod 1 close to the others in turn.

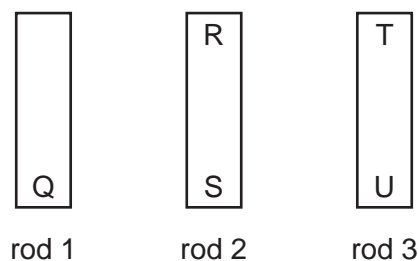

The results are as follows.

End Q: attracts end R,  
 attracts end S,  
 attracts end T,  
 repels end U.

Which of the metal rods is a magnet?

- A** rod 1 only  
**B** rod 1 and rod 2  
**C** rod 1 and rod 3  
**D** rod 3 only
- 27 The diagram shows two bar magnets, stored with metal keepers across the ends. The keepers help to keep the magnets magnetised.

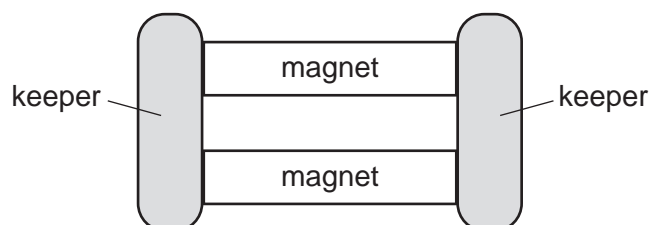

The material used for the keepers becomes strongly magnetised when placed in contact with the magnets, but does not remain magnetised when taken away from the magnets.

What is a suitable metal to use for the magnets and what is a suitable metal to use for the keepers?

	metal for magnets	metal for keepers
<b>A</b>	iron	iron
<b>B</b>	iron	steel
<b>C</b>	steel	iron
<b>D</b>	steel	steel

28 Four wires are made from the same material.

Which wire has the least resistance?

	diameter of wire / mm	length of wire / cm
<b>A</b>	0.2	100
<b>B</b>	0.2	200
<b>C</b>	0.4	100
<b>D</b>	0.4	200

29 A  $30\ \Omega$  resistor is connected in series with another resistor and a  $6.0\text{V}$  battery. The current in the circuit is  $0.12\text{A}$ . A voltmeter is connected across the other resistor.

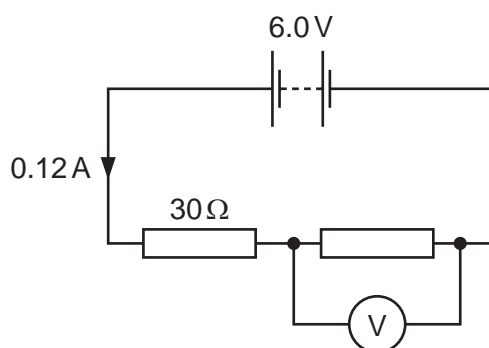

What is the reading on the voltmeter?

- A**  $2.4\text{V}$       **B**  $3.6\text{V}$       **C**  $6.0\text{V}$       **D**  $9.6\text{V}$

30 A circuit contains four ammeters **A**, **B**, **C** and **D**, and three resistors with different values.

Which ammeter shows the largest reading?

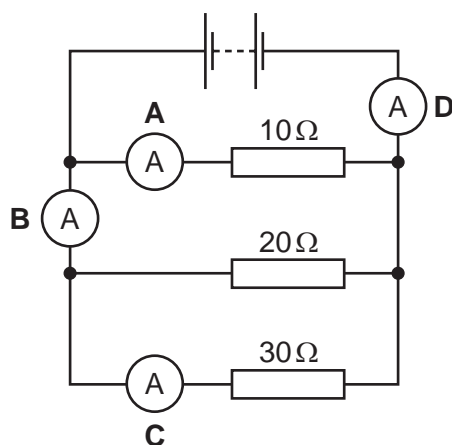

31 The diagram shows a torch containing two cells, a switch and a lamp.

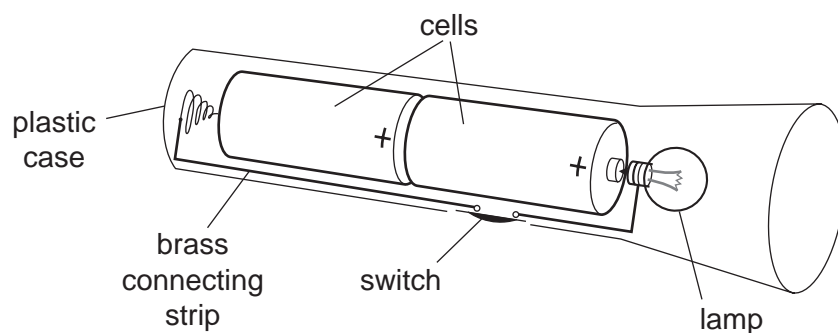

Which is the circuit diagram for the torch?

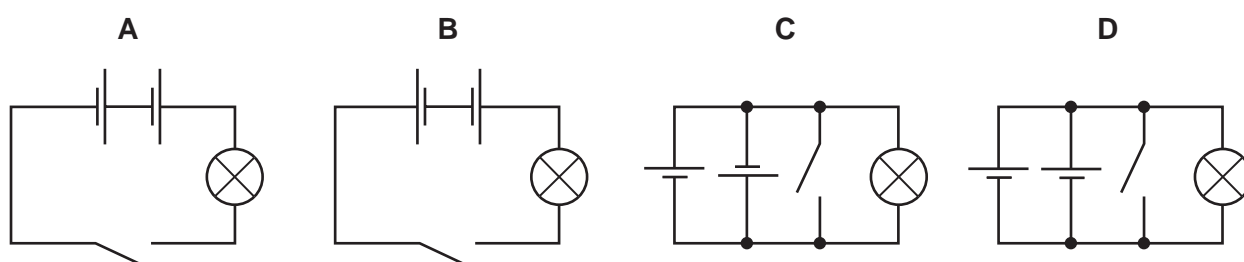

32 The diagram shows a circuit with a fixed resistor connected in series with a light-dependent resistor (LDR). A voltmeter is connected across the LDR.

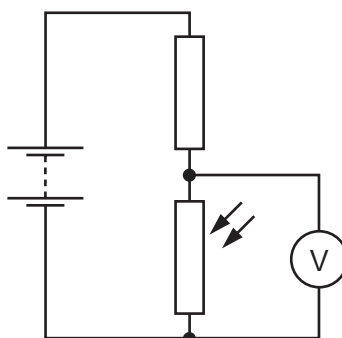

A bright lamp shines light onto the LDR. The lamp is then switched off and this causes the voltmeter reading to change.

Which row shows the change in the resistance of the LDR and the change in the voltmeter reading when the lamp is switched off?

	resistance of LDR	voltmeter reading
<b>A</b>	decreases	decreases
<b>B</b>	decreases	increases
<b>C</b>	increases	decreases
<b>D</b>	increases	increases

- 33 The current in an electrical heater is 5.0 A.

The heater is connected to the mains by a flexible cable that can carry a current of up to 15 A. The mains circuit can carry a current of up to 30 A.

Different fuses are available for the heater.

Which fuse is the most suitable?

- A** 4.0 A                      **B** 10 A                      **C** 20 A                      **D** 40 A

- 34 The diagram shows a thin copper wire in a magnetic field. The current in the wire is from right to left. This causes an upward force on the wire.

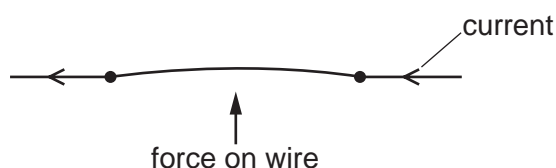

The direction of the current and the direction of the magnetic field are both reversed.

In which direction does the force act on the wire, after these changes are made?

- A** downwards  
**B** into the page  
**C** out of the page  
**D** upwards
- 35 A solenoid is connected to a very sensitive ammeter. A rod is inserted into one end of the solenoid. The ammeter shows that there is a small electric current in the circuit while the rod is moving.

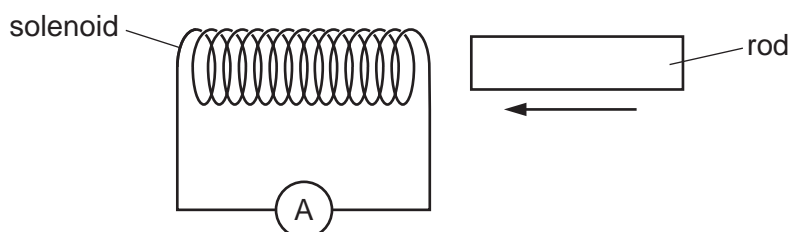

Which rod is being inserted?

- A** a heated copper rod  
**B** a magnetised steel rod  
**C** an uncharged nylon rod  
**D** a radioactive uranium rod



36 The diagram shows the structure of a transformer.

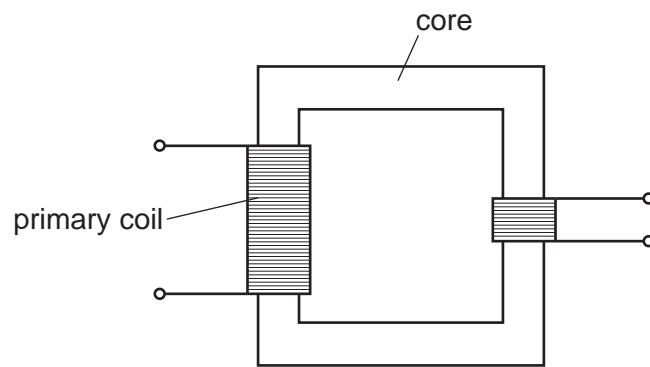

Which row shows a suitable material for the primary coil and a suitable material for the core?

	primary coil	core
<b>A</b>	copper	copper
<b>B</b>	copper	iron
<b>C</b>	iron	copper
<b>D</b>	iron	iron

37 In a cathode-ray tube, a hot tungsten cathode releases particles by thermionic emission.

What are these particles?

- A**  $\alpha$ -particles
- B** electrons
- C** protons
- D** tungsten atoms

38 A radioactive source emits three types of radiation R, S and T.

The diagram shows an experiment set up to study the penetrating properties of R, S and T.

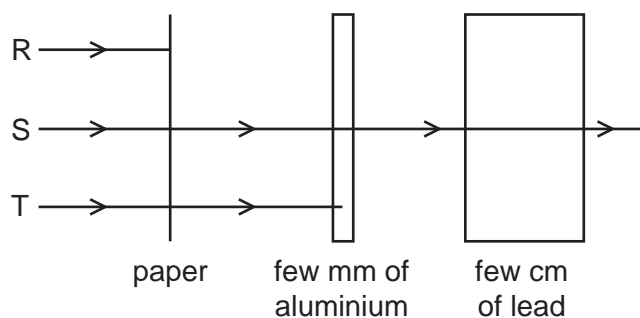

Which types of radiation are R, S and T?

	R	S	T
<b>A</b>	$\alpha$ -particles	$\beta$ -particles	$\gamma$ -rays
<b>B</b>	$\alpha$ -particles	$\gamma$ -rays	$\beta$ -particles
<b>C</b>	$\beta$ -particles	$\alpha$ -particles	$\gamma$ -rays
<b>D</b>	$\gamma$ -rays	$\beta$ -particles	$\alpha$ -particles

39 The half-life of a radioactive substance is 10 minutes. A sample of the radioactive substance contains 2000 nuclei.

How many radioactive nuclei were in the sample half an hour earlier?

- A** 250                      **B** 4000                      **C** 6000                      **D** 16 000

40 Which statement about the nuclei of all atoms is correct?

- A** They are very small compared with the size of the atoms.  
**B** They always contain the same number of protons as neutrons.  
**C** They contain electrons, neutrons and protons.  
**D** They have a total charge of zero.



**BLANK PAGE**

---

Permission to reproduce items where third-party owned material protected by copyright is included has been sought and cleared where possible. Every reasonable effort has been made by the publisher (UCLES) to trace copyright holders, but if any items requiring clearance have unwittingly been included, the publisher will be pleased to make amends at the earliest possible opportunity.

Cambridge International Examinations is part of the Cambridge Assessment Group. Cambridge Assessment is the brand name of University of Cambridge Local Examinations Syndicate (UCLES), which is itself a department of the University of Cambridge.