



UNIVERSITY OF CAMBRIDGE INTERNATIONAL EXAMINATIONS
International General Certificate of Secondary Education

CANDIDATE
NAME

CENTRE
NUMBER

--	--	--	--	--

CANDIDATE
NUMBER

--	--	--	--

MATHEMATICS

0580/42

Paper 4 (Extended)

May/June 2012

2 hours 30 minutes

Candidates answer on the Question Paper.

Additional Materials:

Electronic calculator
Mathematical tables (optional)

Geometrical instruments
Tracing paper (optional)

READ THESE INSTRUCTIONS FIRST

Write your Centre number, candidate number and name on all the work you hand in.

Write in dark blue or black pen.

You may use a pencil for any diagrams or graphs.

Do not use staples, paper clips, highlighters, glue or correction fluid.

DO NOT WRITE IN ANY BARCODES.

Answer **all** questions.

If working is needed for any question it must be shown below that question.

Electronic calculators should be used.

If the degree of accuracy is not specified in the question, and if the answer is not exact, give the answer to three significant figures. Give answers in degrees to one decimal place.

For π use either your calculator value or 3.142.

At the end of the examination, fasten all your work securely together.

The number of marks is given in brackets [] at the end of each question or part question.

The total of the marks for this paper is 130.

This document consists of **16** printed pages.



1

For
Examiner's
Use

Mathematics mark	30	50	35	25	5	39	48	40	10	15
English mark	26	39	35	28	9	37	45	33	16	12

The table shows the test marks in Mathematics and English for 10 students.

- (a) (i) On the grid, complete the scatter diagram to show the Mathematics and English marks for the 10 students. The first four points have been plotted for you.

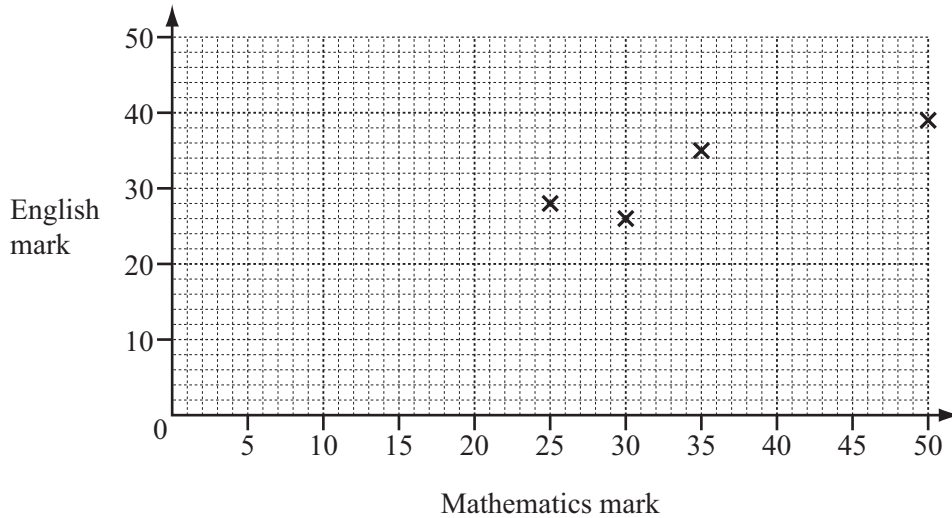

- (ii) What type of correlation does your scatter diagram show? [2]

Answer(a)(ii)

- (iii) Draw a line of best fit on the grid. [1]

- (iv) Ann missed the English test but scored 22 marks in the Mathematics test. Use your line of best fit to estimate a possible English mark for Ann.

Answer(a)(iv)

- (b) Show that the mean English mark for the 10 students is 28.

Answer(b)

[2]

- (c) Two new students do the English test. They both score the **same** mark. The mean English mark for the 12 students is 31. Calculate the English mark for the new students.

Answer(c)

[3]

- 2 (a) In a sale, Jen buys a laptop for \$351.55.
This price is 21% less than the price before the sale.

Calculate the price before the sale.

Answer(a) \$ [3]

- (b) Alex invests \$4000 at a rate of 8% per year simple interest for 2 years.
Bob invests \$4000 at a rate of 7.5% per year compound interest for 2 years.

Who receives more interest and by how much?

Answer(b) receives \$ more interest. [6]

*For
Examiner's
Use*

3 Pablo plants x lemon trees and y orange trees.

(a) (i) He plants at least 4 lemon trees.

Write down an inequality in x to show this information.

Answer(a)(i) [1]

(ii) Pablo plants at least 9 orange trees.

Write down an inequality in y to show this information.

Answer(a)(ii) [1]

(iii) The greatest possible number of trees he can plant is 20.

Write down an inequality in x and y to show this information.

Answer(a)(iii) [1]

(b) Lemon trees cost \$5 each and orange trees cost \$10 each.

The maximum Pablo can spend is \$170.

Write down an inequality in x and y and show that it simplifies to $x + 2y \leq 34$.

Answer (b)

[1]

(c) (i) On the grid opposite, draw four lines to show the four inequalities and shade the **unwanted** region.



[7]

(ii) Calculate the smallest cost when Pablo buys a total of 20 trees.

Answer(c)(ii) \$ [2]

4 (a)

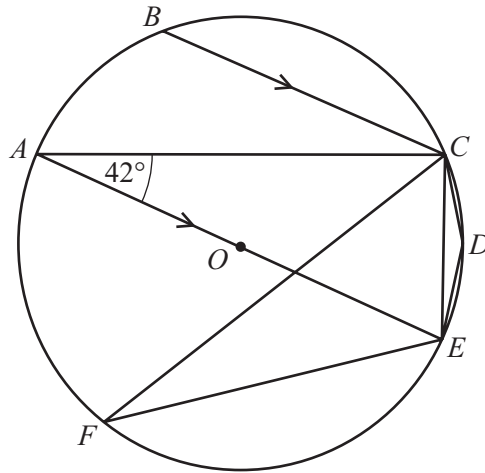
NOT TO
SCALEFor
Examiner's
Use

A, B, C, D, E and F are points on the circumference of a circle centre O .
 AE is a diameter of the circle.
 BC is parallel to AE and angle $CAE = 42^\circ$.

Giving a reason for each answer, find

(i) angle BCA ,

Answer(a)(i) Angle $BCA = \dots\dots\dots$

Reason [2]

(ii) angle ACE ,

Answer(a)(ii) Angle $ACE = \dots\dots\dots$

Reason [2]

(iii) angle CFE ,

Answer(a)(iii) Angle $CFE = \dots\dots\dots$

Reason [2]

(iv) angle CDE .

Answer(a)(iv) Angle $CDE = \dots\dots\dots$

Reason [2]

(b)

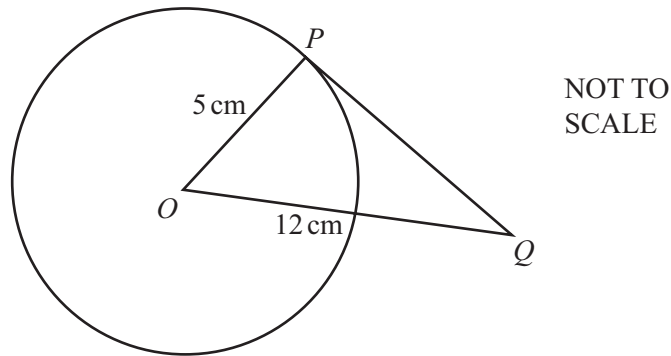

In the diagram, O is the centre of the circle and PQ is a tangent to the circle at P .
 $OP = 5$ cm and $OQ = 12$ cm.

Calculate PQ .

Answer(b) $PQ = \dots\dots\dots$ cm [3]

(c)

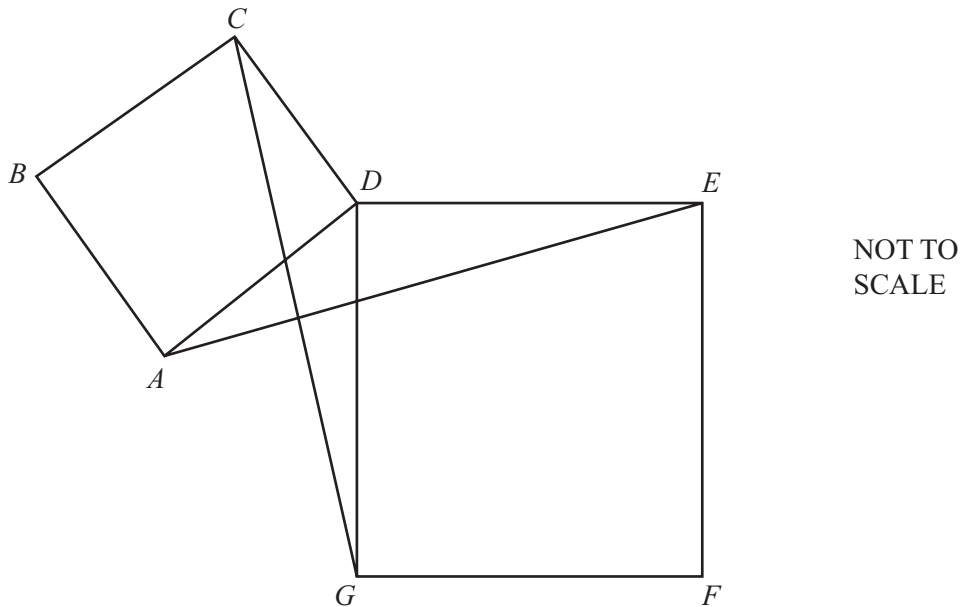

In the diagram, $ABCD$ and $DEFG$ are squares.

(i) In the triangles CDG and ADE , explain with a reason which sides and/or angles are equal.

Answer (c)(i)

[3]

(ii) Complete the following statement.

Triangle CDG is to triangle ADE .

[1]

For
Examiner's
Use

- 5 (a) In Portugal, Miguel buys a book about planets.
The book costs €34.95.
In England the same book costs £27.50.
The exchange rate is £1 = €1.17.

Calculate the difference in pounds (£) between the cost of the book in Portugal and England.

Answer(a) £ [2]

- (b) In the book, the distance between two planets is given as 4.07×10^{12} kilometres.
The speed of light is 1.1×10^9 kilometres per hour.

Calculate the time taken for light to travel from one of these planets to the other.
Give your answer in days and hours.

Answer(b) days hours [3]

- (c) In one of the pictures in the book, a rectangle is drawn.
The rectangle has length 9.3 cm and width 5.6 cm, both correct to one decimal place.

- (i) What is the lower bound for the length?

Answer(c)(i) cm [1]

- (ii) Work out the lower and upper bounds for the area of the rectangle.

Answer(c)(ii) Lower bound = cm^2

Upper bound = cm^2 [2]

6 (a)

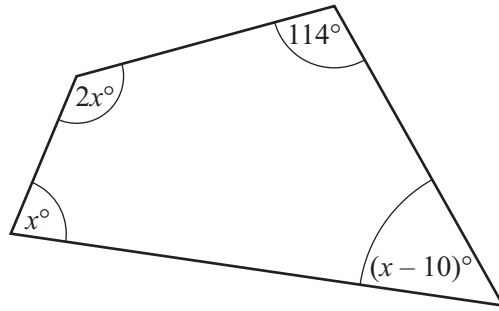

NOT TO SCALE

Find the value of x .

Answer(a) $x = \dots\dots\dots$ [3]

(b) (i) Write the four missing terms in the table for sequences A, B, C and D.

Term	1	2	3	4	5		n
Sequence A	-4		2	5	8		$3n - 7$
Sequence B	1	4	9	16	25		
Sequence C	5	10	15	20	25		
Sequence D	6	14	24	36	50		

[4]

(ii) Which term in sequence D is equal to 500?

Answer(b)(ii) $\dots\dots\dots$ [2]

(c) Simplify $\frac{x^2 - 16}{2x^2 + 7x - 4}$.

Answer(c) $\dots\dots\dots$ [4]

For Examiner's Use

7 (a) P is the point $(2, 5)$ and $\vec{PQ} = \begin{pmatrix} 3 \\ -2 \end{pmatrix}$.

Write down the co-ordinates of Q .

Answer(a) (..... ,) [1]

(b)

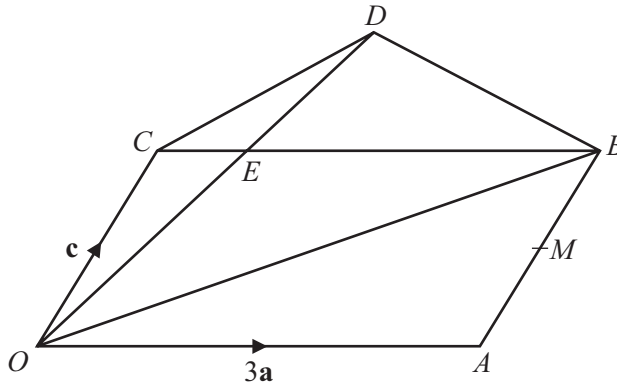

NOT TO
SCALE

O is the origin and $OACB$ is a parallelogram.
 M is the midpoint of AB .

$\vec{OC} = \mathbf{c}$, $\vec{OA} = 3\mathbf{a}$ and $CE = \frac{1}{3}CB$.

OED is a straight line with $OE : ED = 2 : 1$.

Find in terms of \mathbf{a} and \mathbf{c} , in their simplest forms

(i) \vec{OB} ,

Answer(b)(i) $\vec{OB} = \dots\dots\dots$ [1]

(ii) the position vector of M ,

Answer(b)(ii) $\dots\dots\dots$ [2]

(iii) \vec{OE} ,

Answer(b)(iii) $\vec{OE} = \dots\dots\dots$ [1]

(iv) \vec{CD} .

Answer(b)(iv) $\vec{CD} = \dots\dots\dots$ [2]

(c) Write down two facts about the lines CD and OB .

Answer (c) $\dots\dots\dots$
 $\dots\dots\dots$ [2]

8 In all parts of this question give your answer as a fraction in its lowest terms.

For
Examiner's
Use

(a) (i) The probability that it will rain today is $\frac{1}{3}$.

What is the probability that it will not rain today?

Answer(a)(i) [1]

(ii) If it rains today, the probability that it will rain tomorrow is $\frac{2}{5}$.

If it does not rain today, the probability that it will rain tomorrow is $\frac{1}{6}$.

Complete the tree diagram.

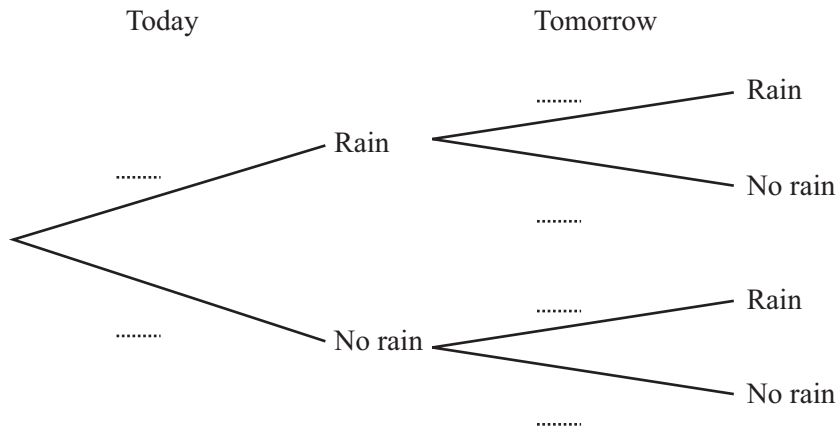

[2]

(b) Find the probability that it will rain on at least one of these two days.

Answer(b) [3]

(c) Find the probability that it will rain on only one of these two days.

Answer(c) [3]

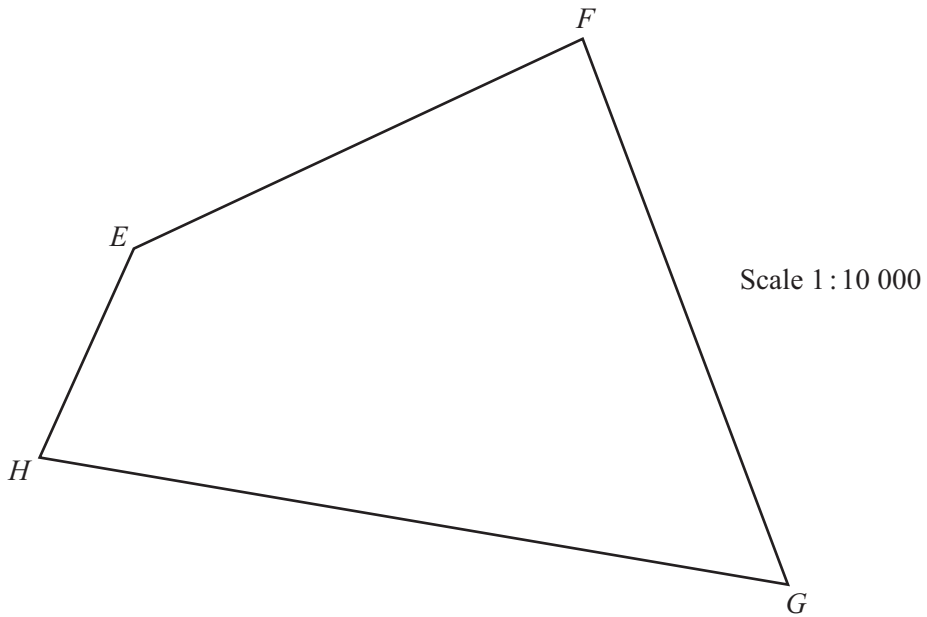

The diagram is a scale drawing of a park $EFGH$. The scale is 1:10 000.

A statue is to be placed in the park so that it is

- nearer to G than to H
- nearer to HG than to FG
- more than 550 metres from F .

Construct accurately the boundaries of the region R in which the statue can be placed.

Leave in all your construction arcs and shade the region R .

[7]

10 (a) Simplify

(i) $(2x^2y^3)^3$,

Answer(a)(i) [2]

(ii) $\left(\frac{27}{x^6}\right)^{-\frac{1}{3}}$.

Answer(a)(ii) [3]

(b) Multiply out and simplify.

$$(3x - 2y)(2x + 5y)$$

Answer(b) [3]

(c) Make h the subject of

(i) $V = \pi r^3 + 2\pi r^2 h$,

Answer(c)(i) $h =$ [2]

(ii) $V = \sqrt{3h}$.

Answer(c)(ii) $h =$ [2]

(d) Write as a single fraction in its simplest form.

$$\frac{x}{2} + \frac{5x}{3} - \frac{7x}{4}$$

Answer(d) [2]

11 (a) Calculate the area of a circle with radius 12 cm.

For
Examiner's
Use

Answer(a) cm² [2]

(b)

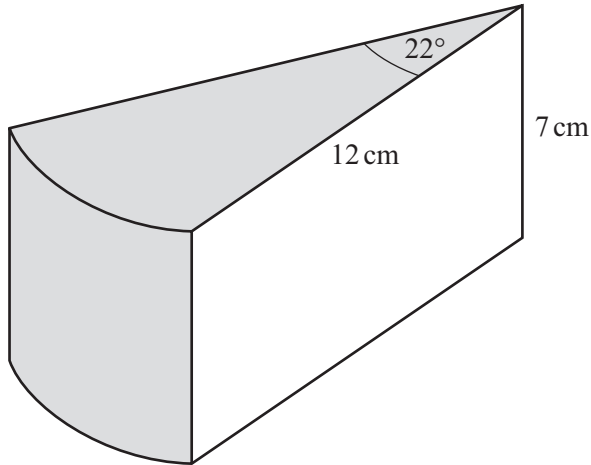

NOT TO
SCALE

A circular cake has radius 12 cm and height 7 cm.
The uniform cross-section of a slice of the cake is a sector with angle 22°.
The top and the curved surface of the slice, shaded in the diagram, are covered with chocolate.

Calculate the area of the slice which is covered with chocolate.

Answer(b) cm² [5]

(c)

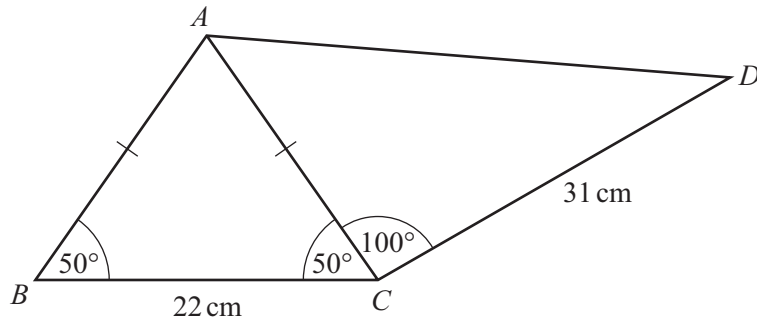
NOT TO
SCALE

The frame of a child's bicycle is made from metal rods.
 ABC is an isosceles triangle with base 22 cm and base angles 50° .
 Angle $ACD = 100^\circ$ and $CD = 31$ cm.

Calculate the length AD .

Answer(c) $AD =$ cm [6]

Question 12 is printed on the next page.

For
Examiner's
Use

- 12 (a) The cost of 1 kg of tomatoes is \$ x and the cost of 1 kg of onions is \$ y .

Ian pays a total of \$10.70 for 10 kg of tomatoes and 4 kg of onions.

Jao pays a total of \$10.10 for 8 kg of tomatoes and 6 kg of onions.

Write down simultaneous equations and solve them to find x and y .

For
Examiner's
Use

Answer(a) $x =$

$y =$ [6]

- (b) Solve $2x^2 - 5x - 8 = 0$.

Give your answers correct to 2 decimal places.
Show all your working.

Answer(b) $x =$ or $x =$ [4]

Permission to reproduce items where third-party owned material protected by copyright is included has been sought and cleared where possible. Every reasonable effort has been made by the publisher (UCLES) to trace copyright holders, but if any items requiring clearance have unwittingly been included, the publisher will be pleased to make amends at the earliest possible opportunity.

University of Cambridge International Examinations is part of the Cambridge Assessment Group. Cambridge Assessment is the brand name of University of Cambridge Local Examinations Syndicate (UCLES), which is itself a department of the University of Cambridge.