



Cambridge International Examinations
Cambridge International General Certificate of Secondary Education

BIOLOGY

0610/22

Paper 2 Multiple Choice (Extended)

February/March 2016

45 minutes

Additional Materials: Multiple Choice Answer Sheet
Soft clean eraser
Soft pencil (type B or HB is recommended)

* 7 9 2 1 6 5 8 6 4 7 *

READ THESE INSTRUCTIONS FIRST

Write in soft pencil.

Do not use staples, paper clips, glue or correction fluid.

Write your name, Centre number and candidate number on the Answer Sheet in the spaces provided unless this has been done for you.

DO NOT WRITE IN ANY BARCODES.

There are **forty** questions on this paper. Answer **all** questions. For each question there are four possible answers **A, B, C** and **D**.

Choose the **one** you consider correct and record your choice in **soft pencil** on the separate Answer Sheet.

Read the instructions on the Answer Sheet very carefully.

Each correct answer will score one mark. A mark will not be deducted for a wrong answer.

Any rough working should be done in this booklet.

Electronic calculators may be used.

bestexamhelp.com

The syllabus is approved for use in England, Wales and Northern Ireland as a Cambridge International Level 1/Level 2 Certificate.

This document consists of **15** printed pages and **1** blank page.

1 What is a correct way of naming an organism using the binomial system?

- A *Common buttercup*
- B *ranunculus acris*
- C *Ranunculus acris*
- D *Ranunculus sp.*

2 The diagram shows a leaf.

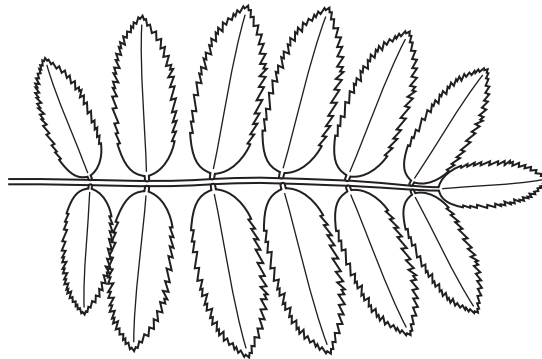

Use the key to identify the plant to which the leaf belongs.

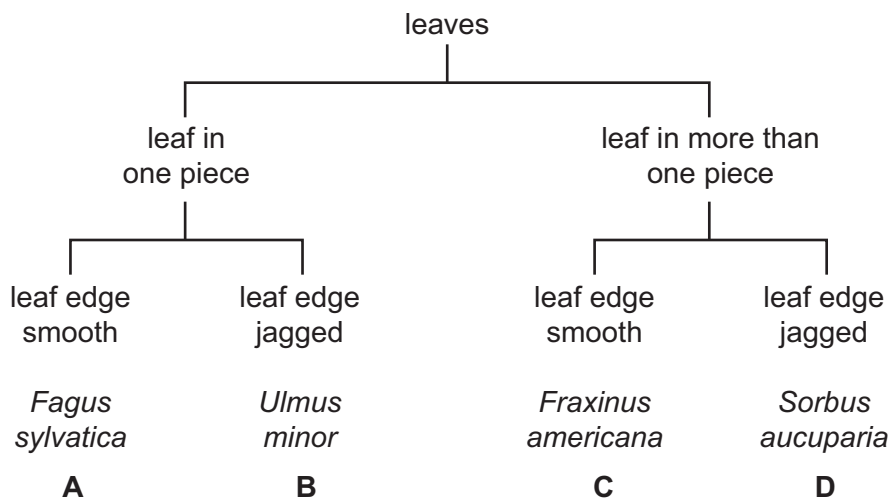

3 The diagram shows a palisade mesophyll cell from a green leaf.

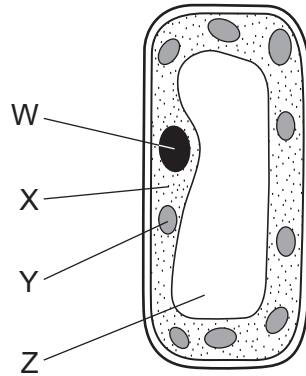

In which labelled part does photosynthesis occur and where is starch stored?

	photosynthesis occurs	starch is stored
A	X	W
B	X	Z
C	Y	X
D	Y	Y

4 The diagram shows the detailed structure of a plant cell.

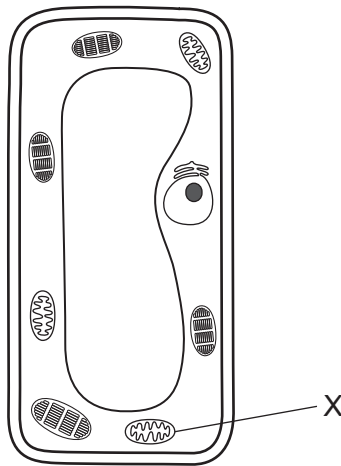

What is organelle X?

- A** chloroplast
- B** mitochondrion
- C** nucleus
- D** vacuole

- 5 The data show the results of an investigation on osmosis using sticks of potato.

concentration of sugar solution / mol per dm ³	length of potato stick at start/mm	length of potato stick after 24 hours/mm
0.6	60	54

Which statements explain this change in length?

	movement of water	cause of the movement
A	into the potato cells	The sugar solution has a higher water potential than the potato cells.
B	into the potato cells	The sugar solution has a lower water potential than the potato cells.
C	out of the potato cells	The sugar solution has a higher water potential than the potato cells.
D	out of the potato cells	The sugar solution has a lower water potential than the potato cells.

- 6 What causes the diffusion of oxygen into a plant cell?

- A** active transport
- B** movement of molecules
- C** osmosis
- D** photosynthesis

- 7 What is **not** an example of active transport?

- A** absorption of water by root hairs
- B** reabsorption of glucose by kidney tubules
- C** uptake of glucose by villi
- D** uptake of ions by root hairs

- 8 The diagram shows a section of DNA, with four bases identified on one strand.

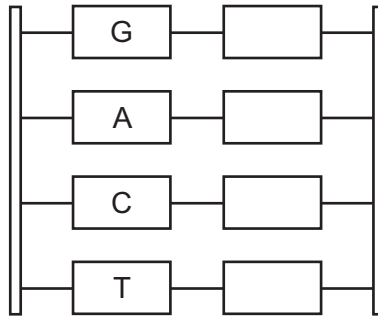

Which sequence of bases would be on the other strand, starting from the top?

- A** AGTC **B** CTGA **C** GACT **D** TCAG
- 9 The diagram shows a large food molecule changing into smaller molecules.

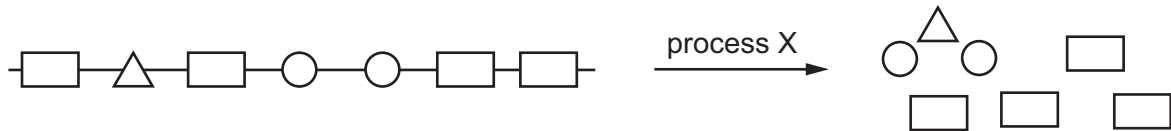

What is process X?

- A** absorption
B chewing
C digestion
D secretion
- 10 The diagram represents the shape of an enzyme molecule.

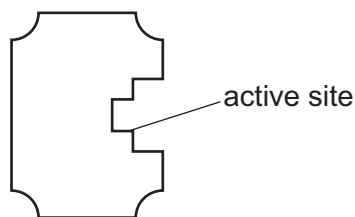

With which substrate would this enzyme most easily form an enzyme-substrate complex?

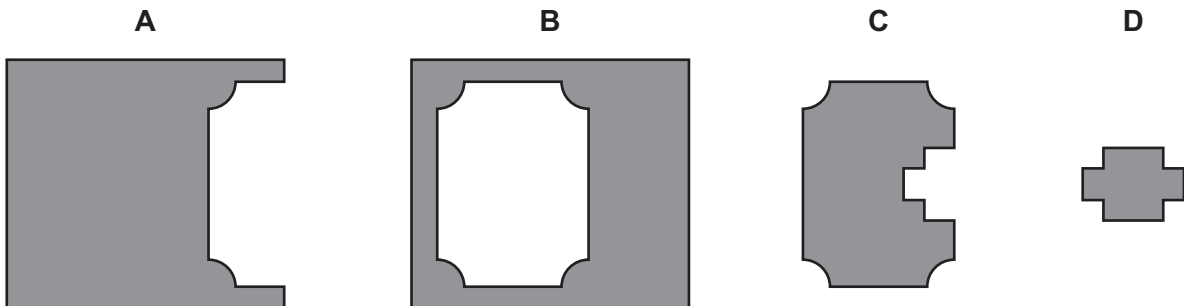

- 11 The table shows the conditions in four test-tubes containing equal amounts of starch and salivary amylase.

In which test-tube is the starch broken down fastest?

	pH	temperature / °C
A	2	27
B	2	37
C	7	27
D	7	37

- 12 A plant with variegated leaves has the starch removed from its leaves by placing it in a dark cupboard for 48 hours.

Black paper is then fixed on one leaf as shown and the plant is exposed to light.

After 24 hours, which part of the leaf contains starch?

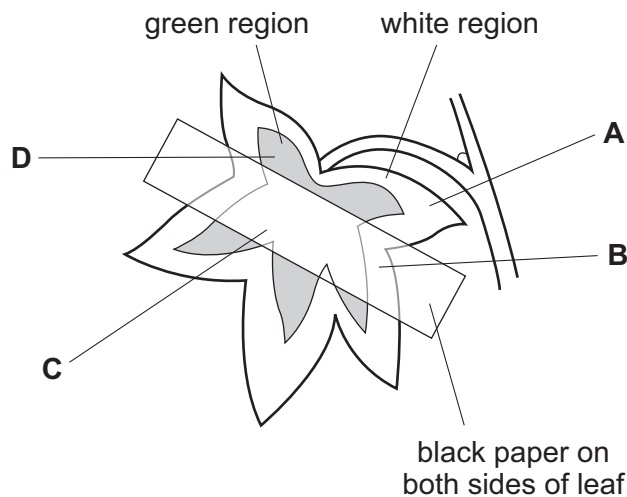

- 13 Which row shows the effects of deficiencies in nitrate and magnesium ions on plant growth?

	effect of nitrate ion deficiency	effect of magnesium ion deficiency
A	green leaves	long roots
B	long roots	thin stem
C	stunted growth	yellow leaves
D	thick stem	large leaves

14 The diagram shows part of the alimentary canal and associated organs.

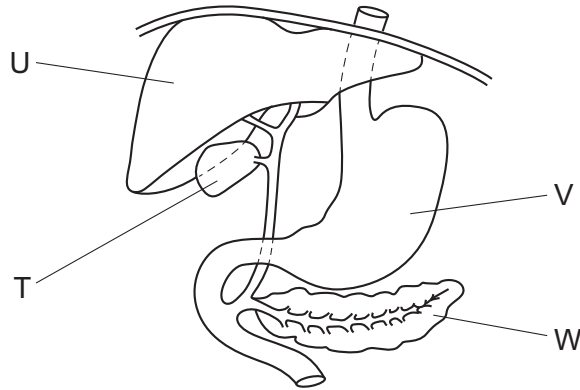

Which structures secrete enzymes that digest proteins?

- A** T and U **B** U and V **C** V and W **D** W and T

15 The graph shows pH changes in the mouth after eating.

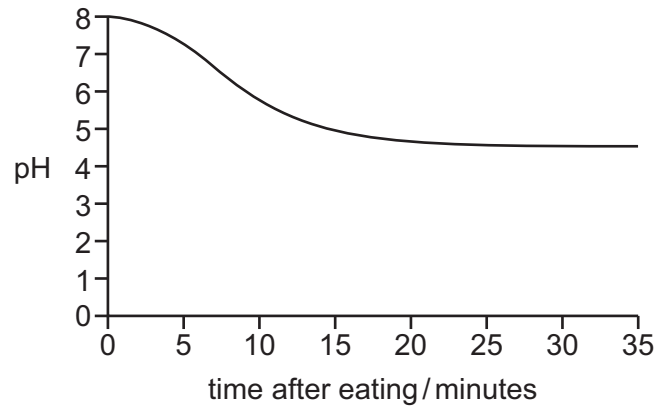

Why is it a good idea to brush teeth after eating?

- A** Acidic conditions help bacteria to grow.
B Acids dissolve tooth enamel.
C Alkaline conditions help bacteria to grow.
D Alkalis dissolve tooth enamel.

- 16 The lower end of a plant stem is placed in water coloured with red dye. After three hours, the stem is cut as shown in the diagram.

Which labelled region is stained red?

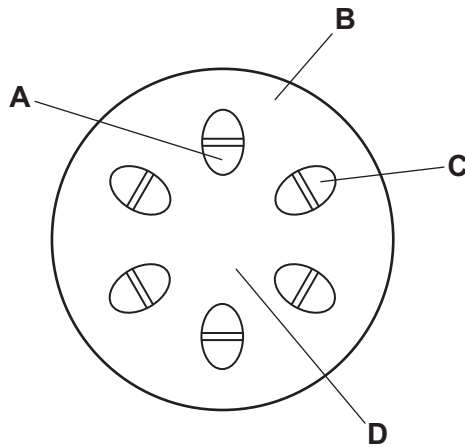

- 17 By which process is water lost from a leaf?

- A active transport
- B diffusion
- C osmosis
- D photosynthesis

- 18 Which process is used to transport sucrose from the leaves of a plant to its flowers?

- A diffusion
- B osmosis
- C translocation
- D transpiration

- 19 Which row shows the chambers of the heart, from those with the thickest walls to those with the thinnest walls?

	thickest	→	thinnest
A	atria	left ventricle	right ventricle
B	atria	right ventricle	left ventricle
C	left ventricle	right ventricle	atria
D	right ventricle	left ventricle	atria

20 Why is aspirin sometimes used as a drug to reduce the risk of coronary heart disease?

- A It reduces blood pressure.
- B It reduces pain.
- C It reduces the tendency for blood to clot.
- D It relaxes artery walls.

21 What happens when a child is vaccinated against tuberculosis?

	type of immunity	production of memory cells
A	active	no
B	active	yes
C	passive	no
D	passive	yes

22 What helps oxygen to be absorbed rapidly into the blood in the lungs?

- A Air breathed in has less oxygen than air breathed out.
- B Alveoli have thick walls and a large surface area.
- C Alveoli have thin walls and a large surface area.
- D The concentration of oxygen in the blood is higher than in the alveoli.

23 The diagram illustrates changes in air pressure taking place inside the lungs during a complete cycle of breathing. Atmospheric pressure is 101 kPa.

At which point on the diagram are the ribs beginning to be lowered?

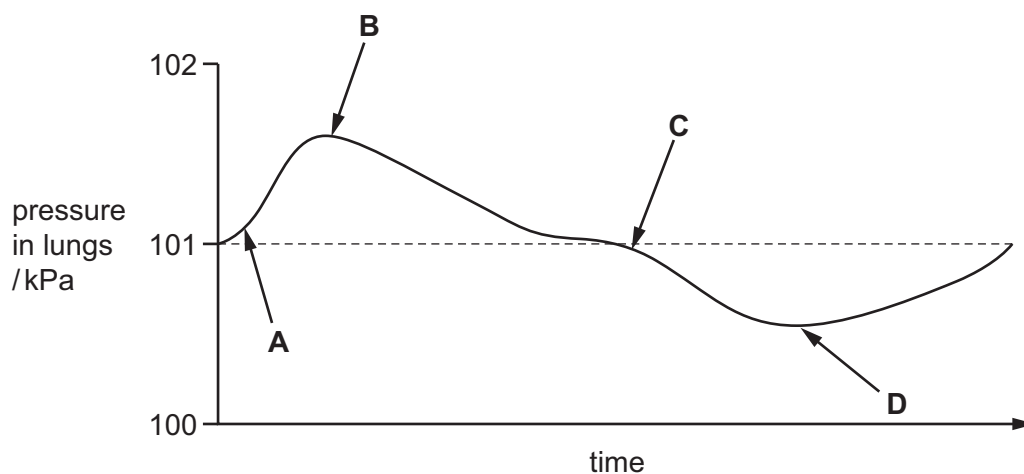

24 The diagram shows the structure of a kidney tubule.

Where does filtration occur?

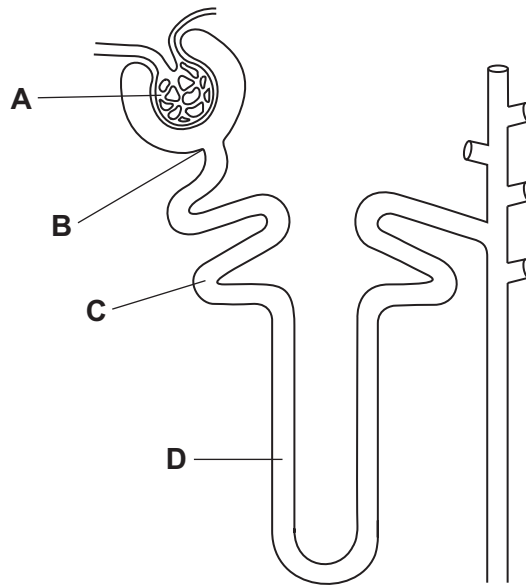

25 The fovea of the eye has three kinds of cones absorbing light of different colours.

Which row is correct?

	type of cone stimulated			
	red sensitive	blue sensitive	green sensitive	colour seen
A	no	yes	yes	red
B	yes	no	yes	blue
C	yes	yes	no	green
D	yes	yes	yes	white

26 A person eats a large bowl of rice.

What happens to the amounts of insulin, glucagon and glycogen in their body?

	insulin	glucagon	glycogen
A	decreases	decreases	increases
B	decreases	increases	decreases
C	increases	decreases	increases
D	increases	increases	decreases

27 What is **not** an effect of the hormone adrenaline?

- A decreased production of sweat
- B dilated pupils
- C increased blood glucose
- D increased pulse rate

28 The diagram shows an experiment to investigate the response of a plant stem to gravity.

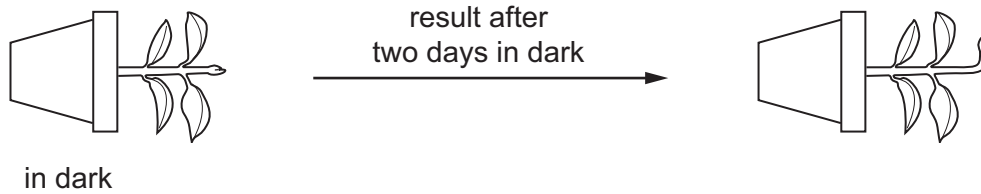

What is a suitable control for this experiment?

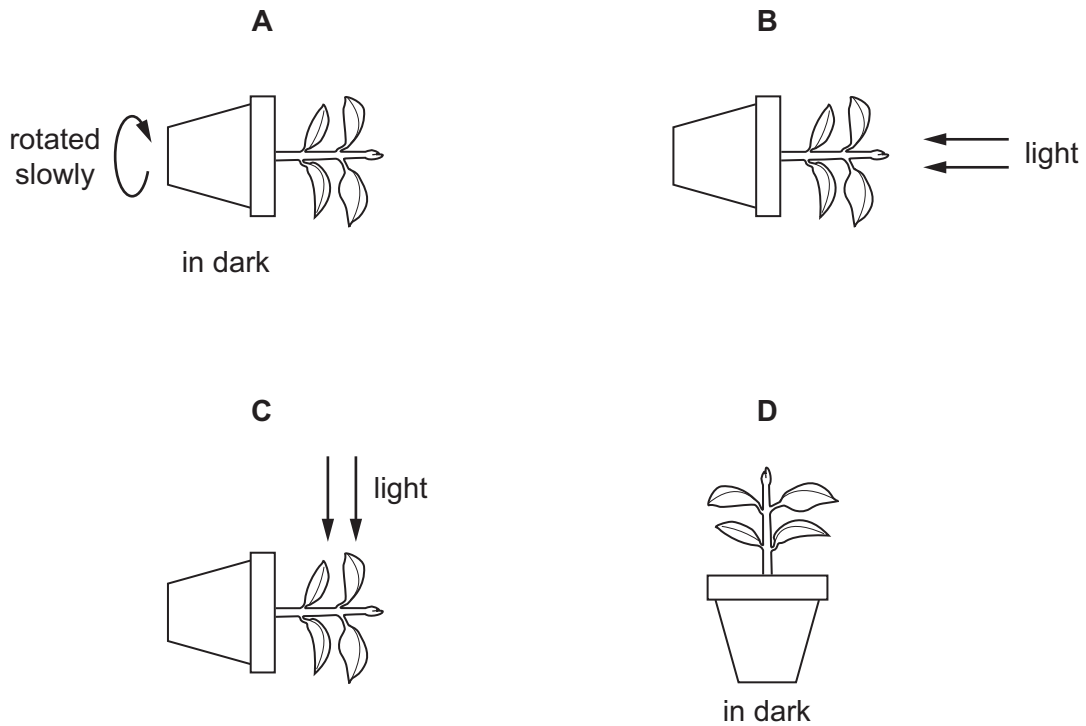

29 Possible effects of drug abuse include

- 1 addiction,
- 2 reduced self-control,
- 3 severe withdrawal symptoms.

Which effects may occur as a result of drinking too much alcohol?

- A 1, 2 and 3
- B 1 and 2 only
- C 1 only
- D 2 and 3 only

30 Which hormone maintains the lining of the uterus during pregnancy?

- A FSH
- B oestrogen
- C progesterone
- D testosterone

31 The diagram shows a flower.

In which structure do seeds develop?

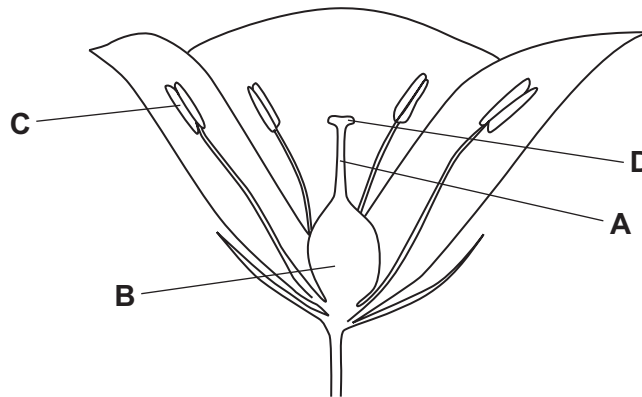

32 In sexual reproduction in humans, why are sperm cells produced in much greater numbers than egg cells?

- A More than one sperm cell fertilises an egg.
- B Sperm cells are small in size.
- C Sperm cells live for only a short time.
- D The chance of one sperm cell reaching an egg is very small.

33 What are alleles?

- A a pair of chromosomes
- B different versions of the same gene
- C the total number of genes on one chromosome
- D two genes side by side on the same chromosome

- 34 The diagram shows the sex chromosomes of a woman and of a man. Their genotypes for a recessive sex-linked condition are also shown.

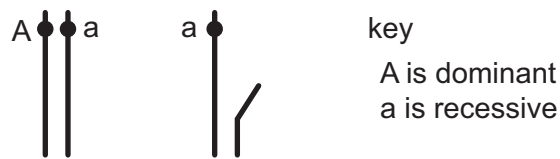

What are the chances that their daughter will show the sex-linked condition?

- A 0% B 25% C 50% D 75%
- 35 The diagram shows the inheritance of ABO blood groups. The blood groups of some of the individuals are given.

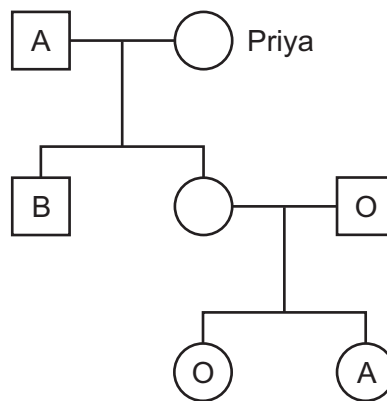

What could be Priya's genotype?

- A $I^A I^O$ B $I^B I^B$ C $I^B I^O$ D $I^O I^O$
- 36 What is **not** a feature of hydrophytes?

- A large air spaces in the tissues
B leaves rolled up and covered with hairs
C leaves with stomata on the upper surface
D roots and xylem reduced

37 The diagram shows a pyramid of numbers in a food chain.

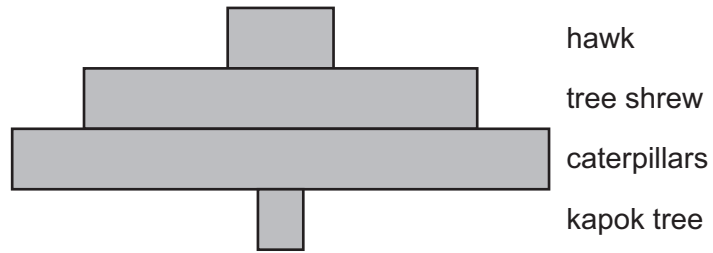

What type of organism is the hawk?

- A producer
 - B primary consumer
 - C quaternary consumer
 - D tertiary consumer
- 38 The diagram shows organisms feeding on a dead rat and one of the organisms which, in turn, feeds on them.



What is needed to complete the food chain?

- A carnivore
- B consumer
- C predator
- D producer

39 The diagram shows five stages in genetic engineering.

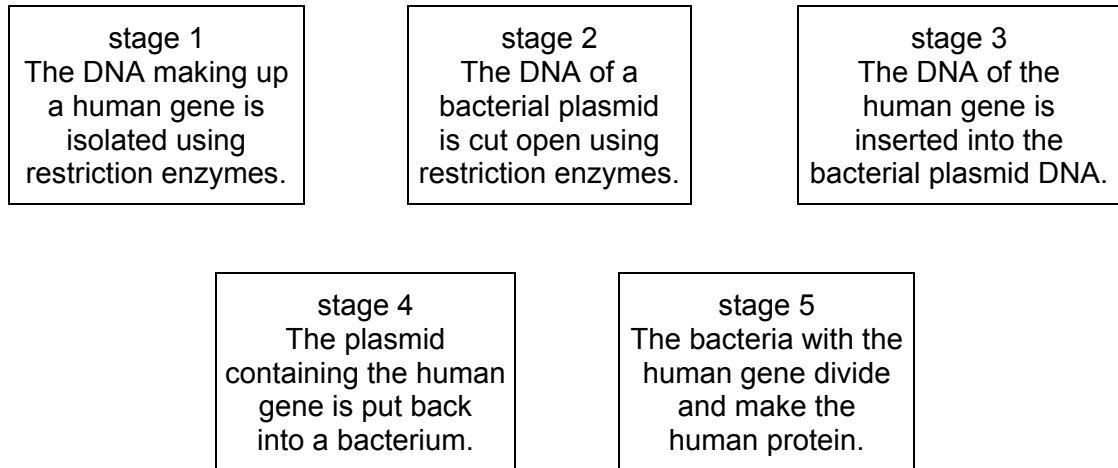

Which stages involve the formation of sticky ends?

- A** 1, 2 and 3 **B** 1 and 2 only **C** 1 and 3 only **D** 2 and 3 only

40 The careless use of nitrogenous fertiliser near rivers and lakes can cause eutrophication.

This results in the death of fish.

What is the direct cause of the death of the fish?

- A** Decomposers reduce the amount of dissolved oxygen in the water.
B Nitrates are toxic to plants.
C The rapid growth of producers uses up all the available nutrients.
D The sudden increase in the number of bacteria increases the spread of disease.

BLANK PAGE

Permission to reproduce items where third-party owned material protected by copyright is included has been sought and cleared where possible. Every reasonable effort has been made by the publisher (UCLES) to trace copyright holders, but if any items requiring clearance have unwittingly been included, the publisher will be pleased to make amends at the earliest possible opportunity.

To avoid the issue of disclosure of answer-related information to candidates, all copyright acknowledgements are reproduced online in the Cambridge International Examinations Copyright Acknowledgements Booklet. This is produced for each series of examinations and is freely available to download at www.cie.org.uk after the live examination series.

Cambridge International Examinations is part of the Cambridge Assessment Group. Cambridge Assessment is the brand name of University of Cambridge Local Examinations Syndicate (UCLES), which is itself a department of the University of Cambridge.