



Cambridge IGCSE™ (9–1)

PHYSICS

0972/11

Paper 1 Multiple Choice (Core)

October/November 2024

45 minutes

You must answer on the multiple choice answer sheet.

You will need: Multiple choice answer sheet
Soft clean eraser
Soft pencil (type B or HB is recommended)

INSTRUCTIONS

- There are **forty** questions on this paper. Answer **all** questions.
- For each question there are four possible answers **A, B, C** and **D**. Choose the **one** you consider correct and record your choice in soft pencil on the multiple choice answer sheet.
- Follow the instructions on the multiple choice answer sheet.
- Write in soft pencil.
- Write your name, centre number and candidate number on the multiple choice answer sheet in the spaces provided unless this has been done for you.
- Do **not** use correction fluid.
- Do **not** write on any bar codes.
- You may use a calculator.
- Take the weight of 1.0 kg to be 9.8 N (acceleration of free fall = 9.8 m/s^2).

INFORMATION

- The total mark for this paper is 40.
- Each correct answer will score one mark.
- Any rough working should be done on this question paper.

This document has **16** pages.



- 1 The diagram shows a rectangular metal sheet close to two rulers.

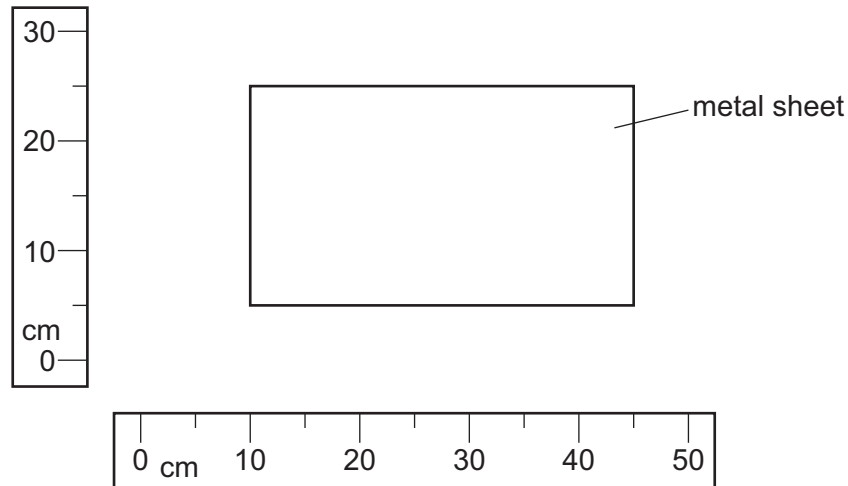

What is the area of the metal sheet?

- A** 700 cm^2 **B** 875 cm^2 **C** 900 cm^2 **D** 1125 cm^2
- 2 The diagram shows the speed–time graph of an object.

In which section does the object have the largest acceleration?

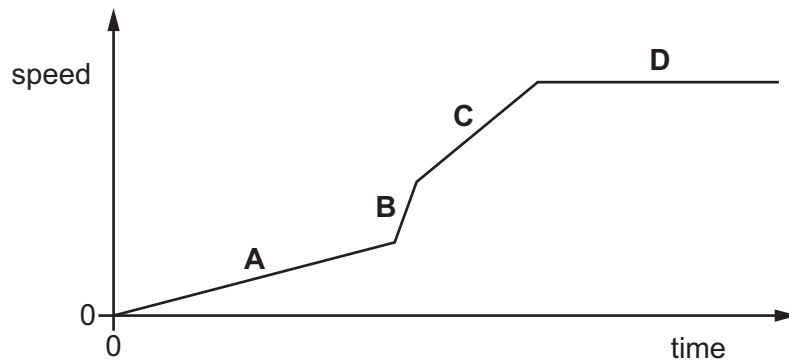

- 3 An object begins to fall close to the Earth's surface. Air resistance can be ignored.

Which statement about the object's acceleration is correct?

- A** The acceleration is constant.
B The acceleration decreases as the body falls.
C The acceleration increases as the body falls.
D The acceleration is zero.

4 Which quantity is equal to gravitational force?

- A gravitational field strength \times mass
- B gravitational field strength \times weight
- C mass per unit weight
- D weight per unit mass

5 A concrete building block has the dimensions shown.

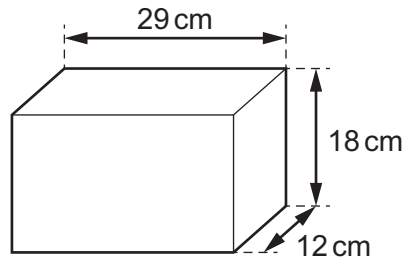

The mass of the block is 15 000 g.

What is the density of the block?

- A 43 g/cm^3 B 2.4 g/cm^3 C 0.42 g/cm^3 D 0.023 g/cm^3

6 What is measured by the moment of a force?

- A the acceleration produced by the force
- B the turning effect of the force
- C the time for which the force acts
- D the increase in energy caused by the force

- 7 Two identical containers, P and Q, are partly filled with different quantities of sand. The position of the centre of gravity for each container is labelled X.

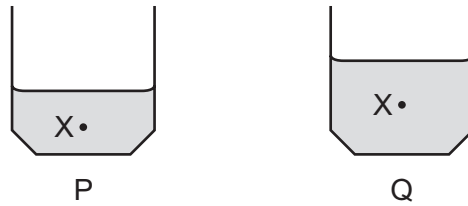

Which container is more stable and what is the reason why it is more stable?

- A** P is more stable because it has a lower centre of gravity.
B P is more stable because it has a smaller mass.
C Q is more stable because it has a greater depth of sand.
D Q is more stable because it has a higher centre of gravity.
- 8 The diagram shows a steel sphere falling through a cylinder of oil.

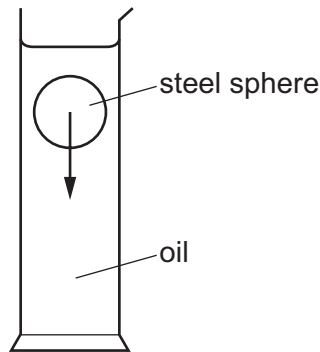

Which row indicates what happens to the steel sphere and what happens to the oil as the steel sphere falls?

	the steel sphere becomes warmer	the oil becomes warmer
A	yes	yes
B	yes	no
C	no	yes
D	no	no

- 9 A moving object is brought to rest by a frictional force of 30 N over a distance of 5.0 m.

The diagram shows the energy transferred between stores.

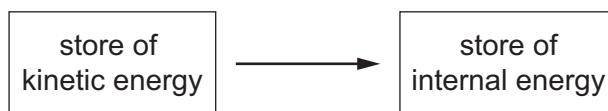

How much energy is transferred by this force and how is the energy transferred?

	energy transferred / J	how the energy is transferred
A	6.0	by electrical working
B	6.0	by mechanical working
C	150	by electrical working
D	150	by mechanical working

- 10 A motor transfers 24 J of energy in 60 seconds.

What is the power output of the motor?

- A** 0.40W **B** 2.5W **C** 24W **D** 1400W

- 11 An artist makes four sculptures with circular bases and places them on sand. All the sculptures are of equal weight and volume.

Which sculpture is least likely to sink into the sand?

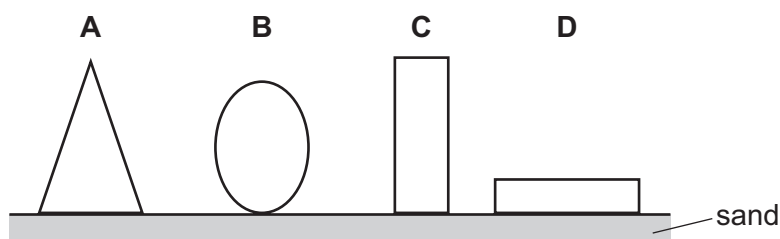

- 12 A quantity of water is boiled to form the same mass of steam.

Which row shows how the volume and density of the water change?

	volume	density
A	decreases	decreases
B	decreases	increases
C	increases	decreases
D	increases	increases

- 13 The diagram represents gas particles moving around in a sealed container.

The gas particles collide with the walls of the container.

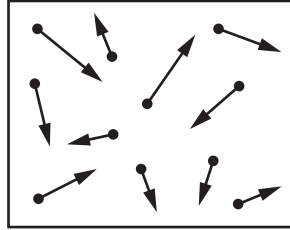

The temperature of the gas is increased.

What happens to the average speed of the gas particles and what happens to the number of collisions by the gas particles with the walls of the container?

	average speed of gas particles	the number of collisions with the walls of the container
A	increases	less frequent collisions
B	increases	more frequent collisions
C	stays the same	less frequent collisions
D	stays the same	more frequent collisions

- 14 A metal object is heated strongly in an oven.

What happens to the volume of the object and the internal energy stored in the object?

	volume	internal energy
A	decreases	decreases
B	decreases	increases
C	increases	decreases
D	increases	increases

- 15 Which row describes the process of melting?

	initial state	final state	change in temperature
A	liquid	gas	yes
B	liquid	solid	no
C	solid	gas	yes
D	solid	liquid	no

16 A beaker of water is heated and thermal energy travels through the water by convection.

What happens to the density of the water when it is heated and how does the water move?

- A The density decreases and the heated water moves downwards.
- B The density decreases and the heated water moves upwards.
- C The density increases and the heated water moves downwards.
- D The density increases and the heated water moves upwards.

17 Waves travel across the surface of water.

What is meant by the amplitude of the wave?

- A the maximum distance of a water particle from its mean position
- B how far the wave travels every second
- C the number of waves passing a point every second
- D the distance between the top of consecutive waves

18 Water waves change direction when they move from shallow water to deep water.

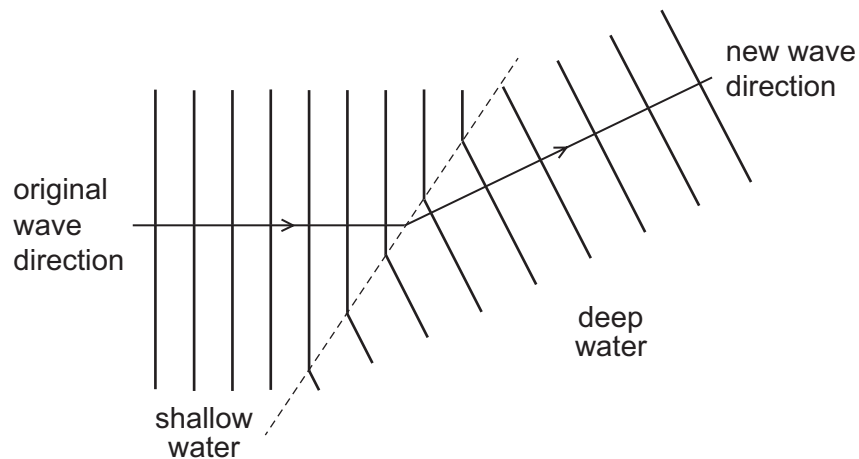

What is the name of this effect?

- A diffraction
- B dispersion
- C reflection
- D refraction

- 19 The ray diagram shows the formation of an image when light is reflected by a plane mirror.

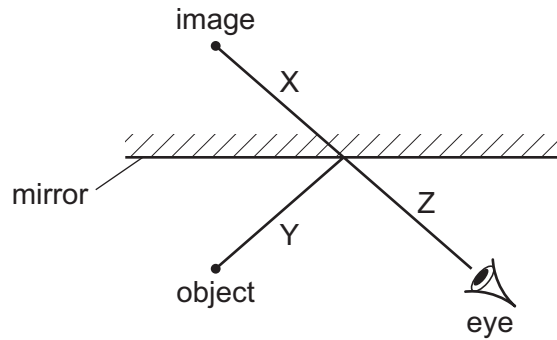

Which lines represent light rays?

- A X, Y and Z B X and Y only C X and Z only D Y and Z only
- 20 Which diagram shows how an image of an object is formed on a screen by a converging lens?

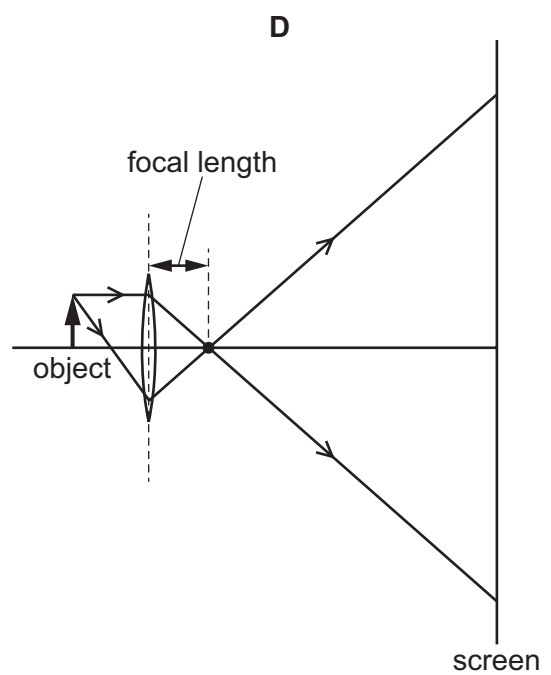
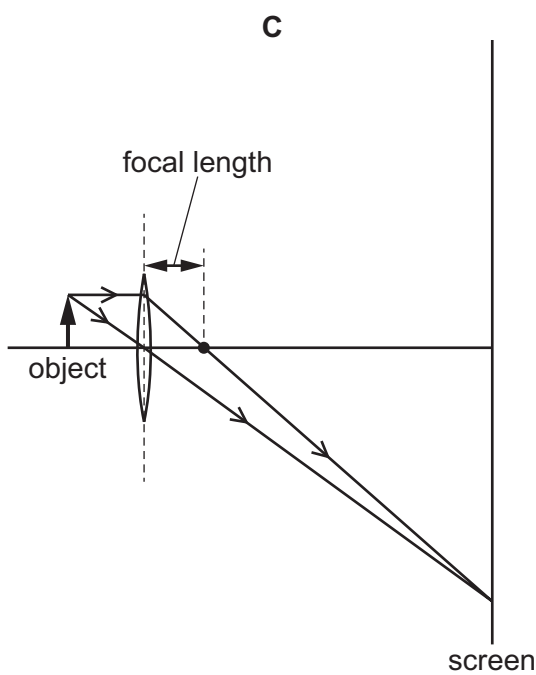
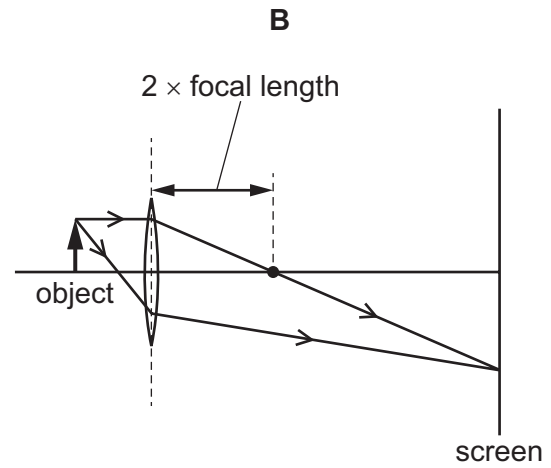
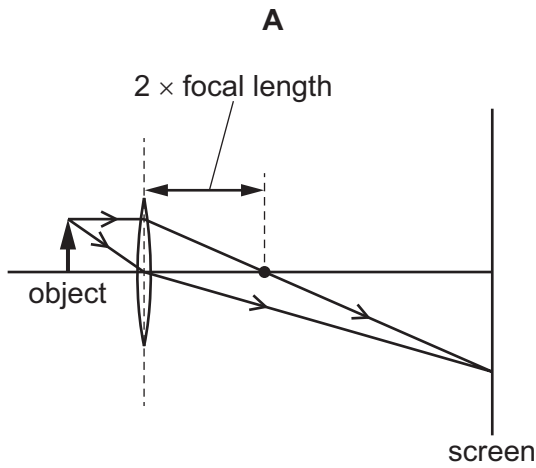

21 Which diagram shows the dispersion of white light by a glass prism?

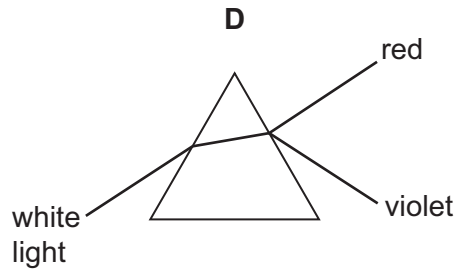
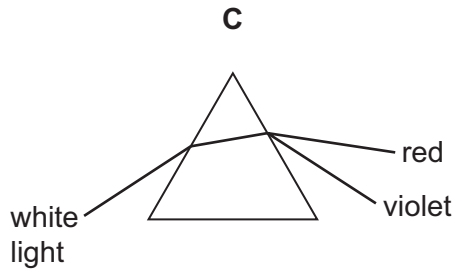
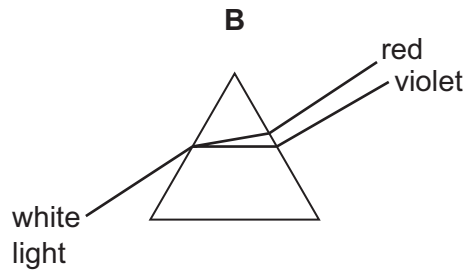
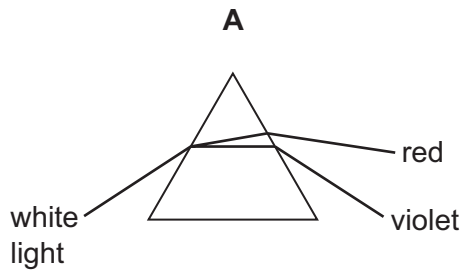

22 Which regions of the electromagnetic spectrum are used for satellite television and for security marking?

	satellite television	security marking
A	microwaves	infrared
B	microwaves	ultraviolet
C	X-rays	infrared
D	X-rays	ultraviolet

23 The horn on a ship makes a sound. The captain on the ship hears an echo from a cliff 4.0 s later.

The speed of sound is 340 m/s.

How far away is the cliff from the ship?

- A** 170 m **B** 340 m **C** 680 m **D** 1400 m

- 24 A bar magnet is next to a steel bar. Some of the magnetic field lines due to the magnet are shown.

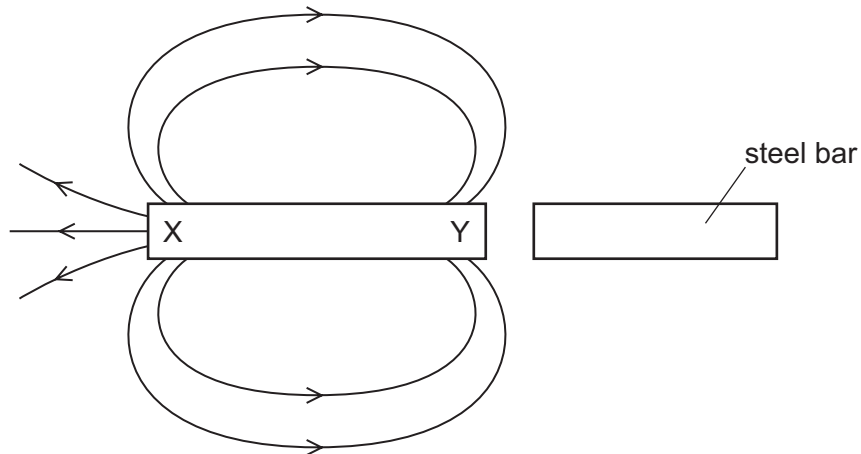

What are the correct poles of the magnet and would the steel bar attract or repel the bar magnet?

	X	Y	force
A	N pole	S pole	attraction
B	N pole	S pole	repulsion
C	S pole	N pole	attraction
D	S pole	N pole	repulsion

- 25 Which row about electrical conduction in metals is correct?

	statement 1	statement 2
A	It is the movement of free electrons.	Electric charge is a flow of current.
B	It is the movement of positive ions.	Electric charge is a flow of current.
C	It is the movement of free electrons.	Electric current is a flow of charge.
D	It is the movement of positive ions.	Electric current is a flow of charge.

26 The diagram shows three wires, P, Q and R. They are all made from the same metal.

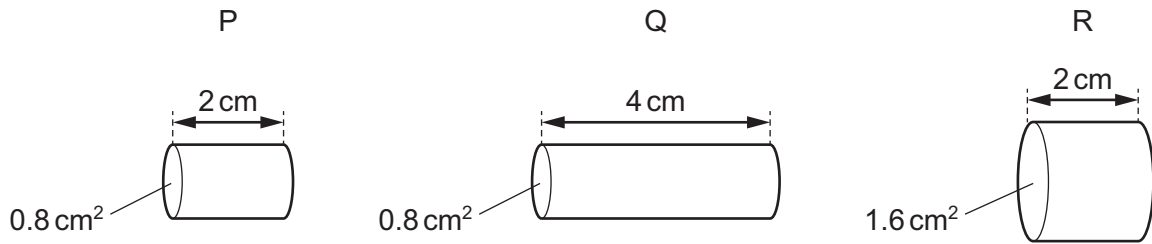

Which list gives the wires in order of resistance, from lowest to highest?

- A P → Q → R
- B Q → R → P
- C R → P → Q
- D R → Q → P

27 A 60W lamp operates at normal brightness for 2.0 minutes.

How much energy is transferred by the lamp?

- A 0.50 J
- B 30 J
- C 120 J
- D 7200 J

28 What is a thermistor?

- A a container to keep a hot liquid warm
- B a circuit to control room temperature
- C a temperature-dependent resistor
- D a heater for a room

29 The diagram shows a circuit containing two identical resistors connected to a battery.

The current is measured at X and at Y.

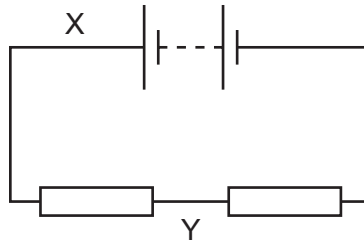

Which row is correct?

	arrangement of resistors	current at Y compared with current at X
A	parallel	less than X
B	parallel	equal to X
C	series	less than X
D	series	equal to X

30 The mains voltage is 120 V.

Which fuse should be fitted to an electric kettle with a power of 1.5 kW?

- A** 3 A **B** 5 A **C** 10 A **D** 13 A

- 31 The diagrams show a strong magnet and a weak magnet moving into the same coil of wire at different speeds.

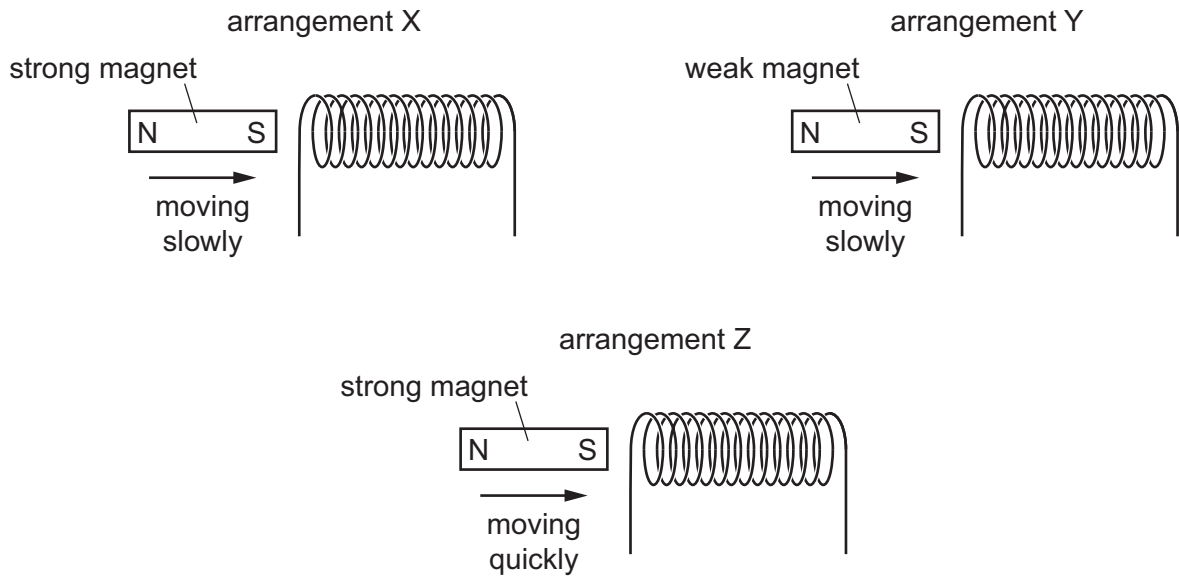

Which arrangement induces the largest electromotive force (e.m.f.) and which arrangement induces the smallest e.m.f.?

	largest e.m.f.	smallest e.m.f.
A	X	Y
B	Y	Z
C	Z	X
D	Z	Y

32 The diagrams show a current-carrying wire with an arrow in the direction of the current.

Which diagram shows the magnetic field produced by the current?

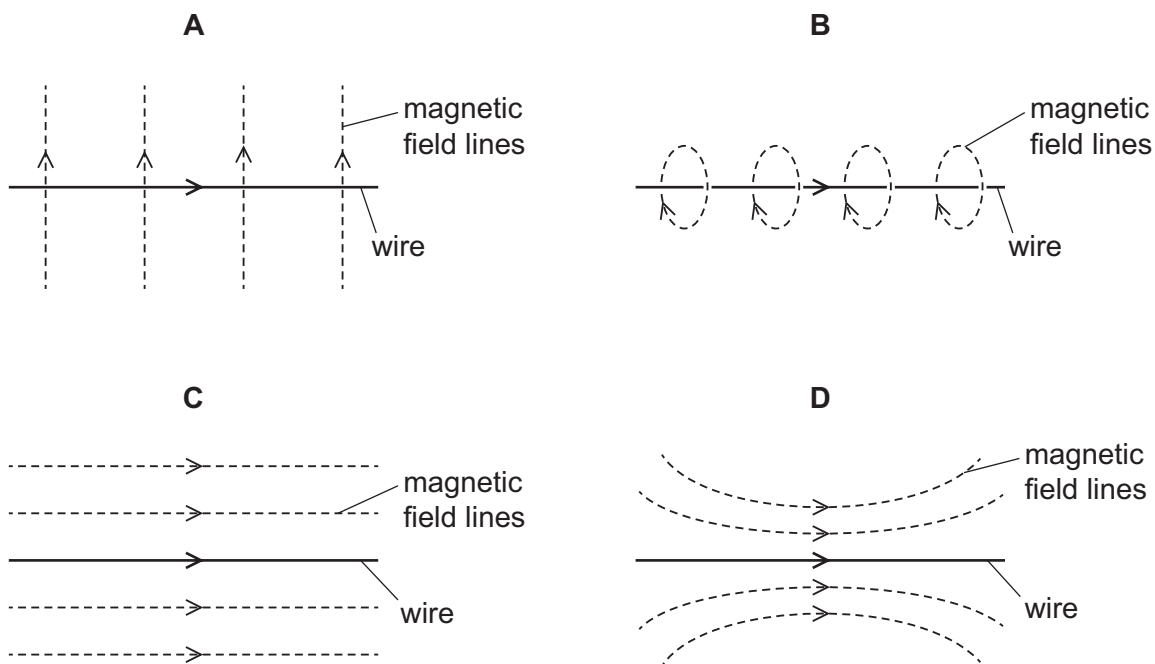

33 What are the best materials to use for the construction of a transformer?

- A copper for the core and steel for the coils wound around it
- B copper for the core and copper for the coils wound around it
- C soft iron for the core and copper for the coils wound around it
- D steel for the core and copper for the coils wound around it

34 Which diagram represents the structure of a neutral atom?

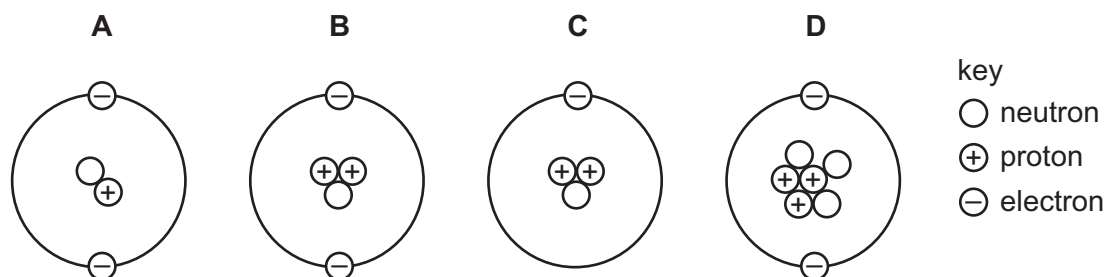

35 The diagram shows five atoms in a radioactive substance. The atoms each give out an α -particle.

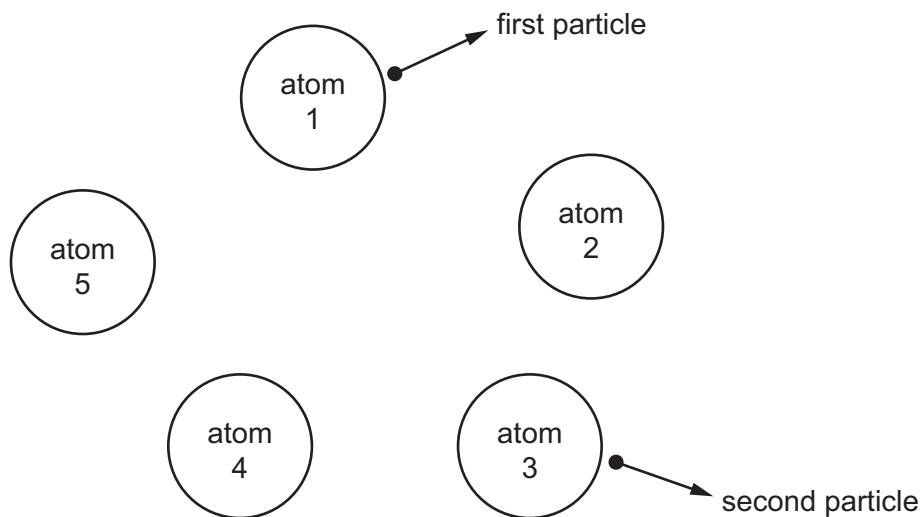

Atom 1 is the first to give out a particle. Atom 3 is the second to give out a particle.

Which atom will give out the next particle?

- A atom 2
- B atom 4
- C atom 5
- D impossible to tell

36 The diagram shows a radioactive source, a thick aluminium sheet and a radiation detector.

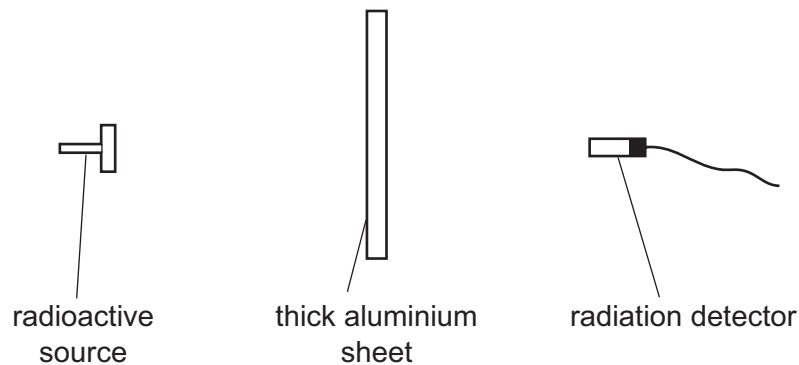

The radiation detector shows a reading greater than the background reading.

Which type of radiation is being emitted by the source and detected by the detector?

- A α -radiation
- B β -radiation
- C γ -radiation
- D infrared radiation

37 The half-life of the radioactive isotope caesium $^{137}_{55}\text{Cs}$ is 30 years.

Starting with 30 g of the isotope, which mass of the isotope remains after 90 years?

- A 10.0 g B 7.50 g C 3.75 g D 1.25 g

38 Which list gives the names of the planets in the correct order?

- A Mercury, Mars, Earth, Venus, Jupiter, Saturn, Uranus, Neptune
 B Mercury, Venus, Earth, Mars, Saturn, Uranus, Jupiter, Neptune
 C Mercury, Venus, Earth, Mars, Jupiter, Saturn, Uranus, Neptune
 D Venus, Mars, Earth, Mercury, Jupiter, Saturn, Uranus, Neptune

39 Which row describes the Sun and the Milky Way?

	the Sun	the Milky Way
A	a galaxy	a galaxy
B	a galaxy	a star
C	a star	a galaxy
D	a star	a star

40 What is the approximate diameter of the Milky Way?

- A 100 light-years
 B 1000 light-years
 C 10 000 light-years
 D 100 000 light-years

Permission to reproduce items where third-party owned material protected by copyright is included has been sought and cleared where possible. Every reasonable effort has been made by the publisher (UCLES) to trace copyright holders, but if any items requiring clearance have unwittingly been included, the publisher will be pleased to make amends at the earliest possible opportunity.

To avoid the issue of disclosure of answer-related information to candidates, all copyright acknowledgements are reproduced online in the Cambridge Assessment International Education Copyright Acknowledgements Booklet. This is produced for each series of examinations and is freely available to download at www.cambridgeinternational.org after the live examination series.

Cambridge Assessment International Education is part of Cambridge Assessment. Cambridge Assessment is the brand name of the University of Cambridge Local Examinations Syndicate (UCLES), which is a department of the University of Cambridge.