



Cambridge IGCSE™ (9–1)

CANDIDATE
NAME

CENTRE
NUMBER

--	--	--	--	--

CANDIDATE
NUMBER

--	--	--	--



PHYSICS

0972/51

Paper 5 Practical Test

May/June 2024

1 hour 15 minutes

You must answer on the question paper.

You will need: The materials and apparatus listed in the confidential instructions

INSTRUCTIONS

- Answer **all** questions.
- Use a black or dark blue pen. You may use an HB pencil for any diagrams or graphs.
- Write your name, centre number and candidate number in the boxes at the top of the page.
- Write your answer to each question in the space provided.
- Do **not** use an erasable pen or correction fluid.
- Do **not** write on any bar codes.
- You may use a calculator.
- You should show all your working and use appropriate units.

INFORMATION

- The total mark for this paper is 40.
- The number of marks for each question or part question is shown in brackets [].

For Examiner's Use	
1	
2	
3	
4	
Total	

This document has **12** pages. Any blank pages are indicated.

1 In this experiment, you will investigate the stretching of a spring.

Refer to Fig. 1.1.

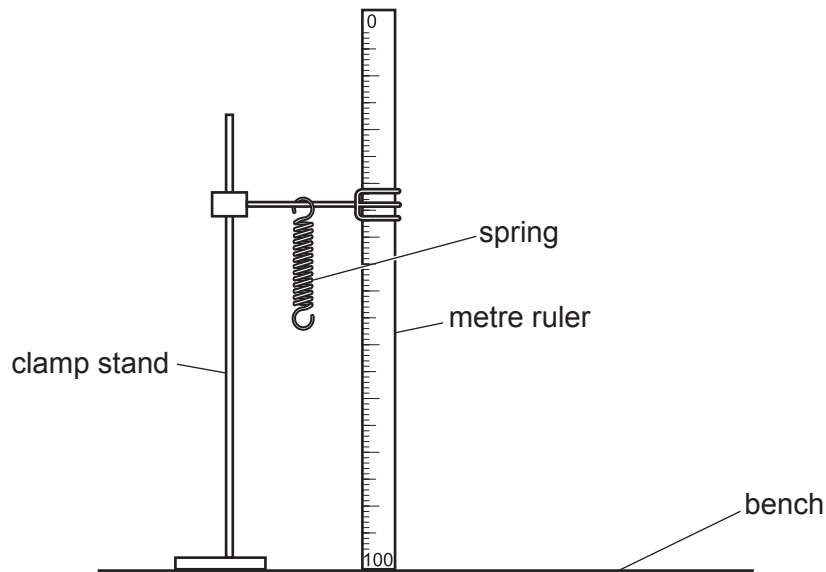

Fig. 1.1

- (a) The metre ruler is clamped in position near to the spring. Do **not** change the position of the metre ruler.
- (i) Measure the unstretched length l_0 of the spring. Record l_0 in cm in Table 1.1. Do **not** include the loops at the ends of the spring in your measurement. The value l_0 is the length of the spring when the load L is 0.00 N. [1]
- (ii) Describe **one** technique you use to obtain an accurate value for l_0 . You may draw a diagram.

.....

.....

..... [1]

- (b)
- Suspend a load $L = 1.00$ N from the spring.
 - Measure and record the new length l of the spring in Table 1.1.
 - Calculate the extension e of the spring using the equation $e = (l - l_0)$.
 - Record the value of e in Table 1.1.
 - Repeat the procedure using loads $L = 2.00$ N, 3.00 N, 4.00 N and 5.00 N.
 - Record all the readings and results in Table 1.1.

Table 1.1

L/N	l/cm	e/cm
0.00		0
1.00		
2.00		
3.00		
4.00		
5.00		

[3]

- (c) Plot a graph of L/N (y -axis) against e/cm (x -axis). Start both axes at the origin $(0, 0)$. Draw the best-fit line.

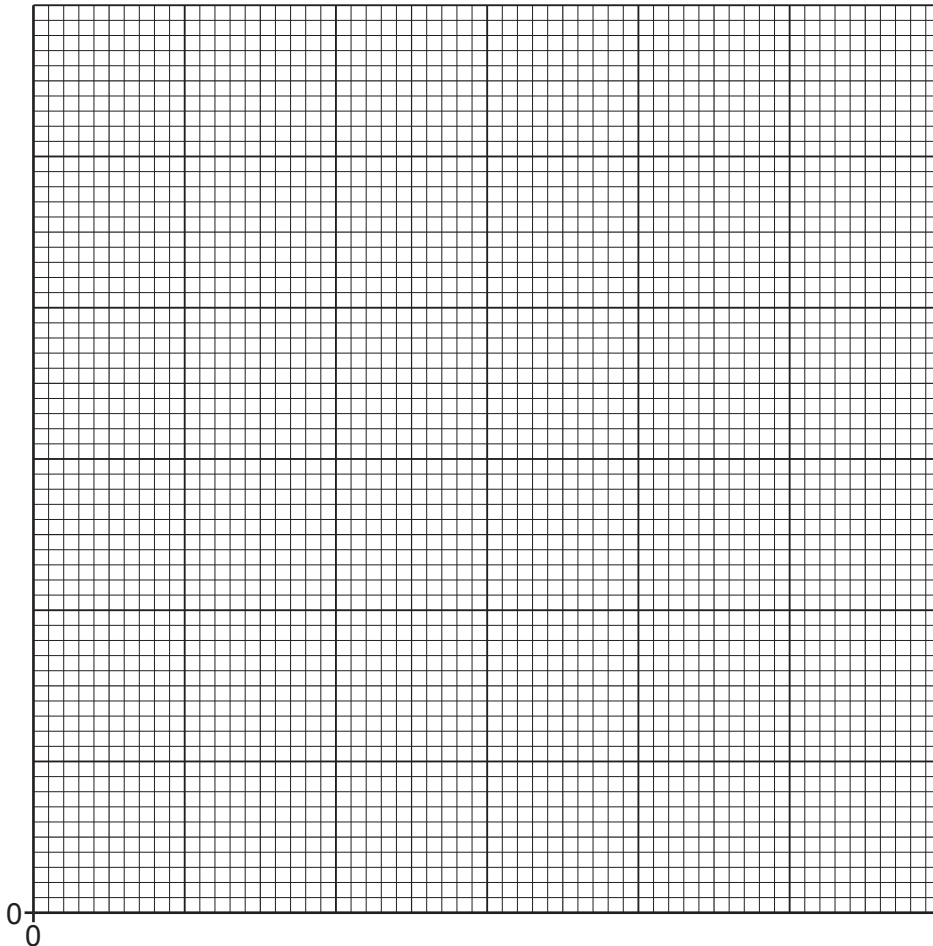

[4]

- (d) Determine the gradient G of the graph. Show all your working and indicate on the graph the values you use.

$$G = \dots\dots\dots [2]$$

[Total: 11]

2 In this experiment, you will investigate the resistance of a wire.

Refer to Fig. 2.1.

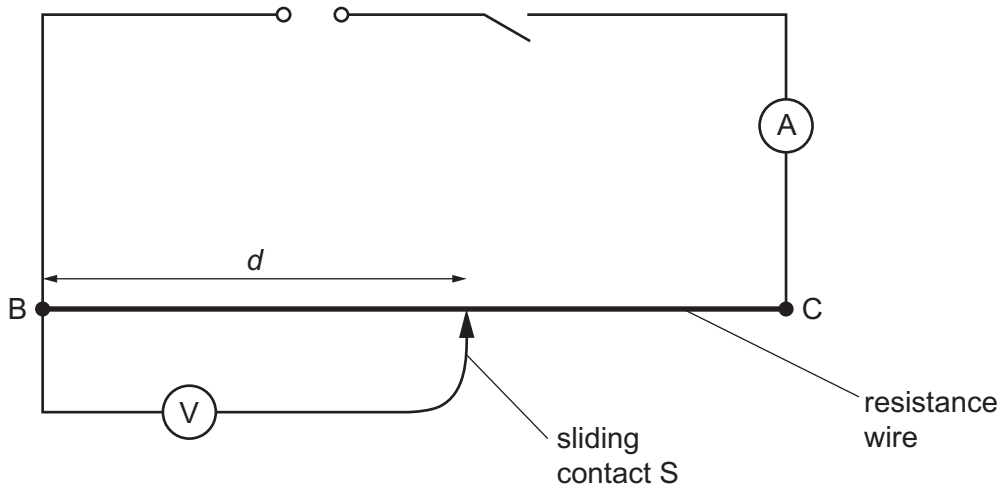

Fig. 2.1

(a) Close the switch.

Measure the current I in the circuit. Include the unit.

$$I = \dots\dots\dots [1]$$

(b) Place the sliding contact S at a distance $d = 50.0$ cm from B.

(i) Measure the potential difference (p.d.) V_{50} across length d of the resistance wire. Include the unit.

Open the switch.

$$V_{50} = \dots\dots\dots [1]$$

(ii) Calculate the resistance R_{50} of 50.0 cm of the resistance wire using the equation $R_{50} = \frac{V_{50}}{I}$.

Include the unit.

$$R_{50} = \dots\dots\dots [1]$$

(iii) Calculate r_1 , a value for the resistance per cm of the resistance wire, using the equation $r_1 = \frac{R_{50}}{d}$, where $d = 50.0$ cm. Include the unit.

$$r_1 = \dots\dots\dots [2]$$

(c) Close the switch.

Repeat the procedure in (b) using $d = 75.0$ cm and calculate r_2 using the equation $r_2 = \frac{R_{75}}{d}$.

Open the switch.

$V_{75} =$

$R_{75} =$

$r_2 =$ [1]

(d) A student suggests that the resistance per cm of the resistance wire is constant.

(i) State whether your results support this suggestion and justify your statement by reference to the results.

statement

justification

.....

..... [2]

(ii) The student plans to plot a graph of resistance R against length d to test the suggestion.

Suggest suitable additional values of length d to use.

..... [2]

(e) A variable resistor is a circuit component that can be made using a coil of resistance wire.

Draw the electrical symbol for a variable resistor.

[1]

[Total: 11]

- 3 In this experiment, you will investigate the image produced by a lens.

Refer to Fig. 3.1 and Fig. 3.2.

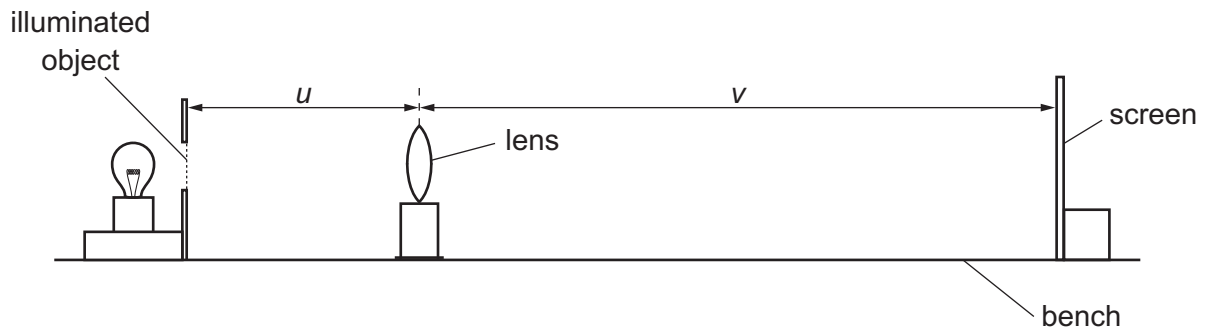

Fig. 3.1

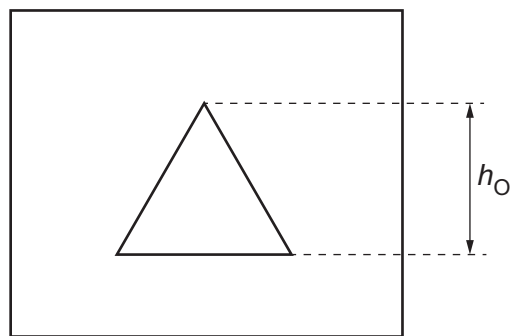

Fig. 3.2

- (a) Measure the height h_O of the illuminated object. Fig. 3.2 shows the height to measure on the illuminated object provided.

$$h_O = \dots\dots\dots [2]$$

- (b) • Place the lens a distance $u = 20.0$ cm from the illuminated object.
• Adjust the position of the screen until a focused image is formed on the screen.

Measure the distance v between the centre of the lens and the screen.

$$v = \dots\dots\dots \text{ cm } [1]$$

- (c) Calculate the focal length f of the lens using the equation $f = \frac{uv}{(u + v)}$.

$$f = \dots\dots\dots \text{ cm } [3]$$

- (d) • Place the lens at a distance $d = 2f$ from the illuminated object.
 • Place the screen at a distance $s = 4f$ from the illuminated object.
 • Adjust the position of the screen until a focused image is formed on the screen.

Record the distance d .

$d =$

Measure the distance x between the lens and the screen.

$x =$ [2]

- (e) Measure the height h_I of the image.

$h_I =$ [2]

- (f) In this type of experiment, it can be difficult to judge the screen position that produces the clearest image.

Suggest **one** precaution or technique to overcome this difficulty.

.....

 [1]

[Total: 11]

- 4 A student investigates the bending of composite strips of wood when they are loaded at one end. The composite strips are made from identical layers of wood stuck together, as shown in Fig. 4.1.

Plan an experiment to investigate how much composite strips bend when they are loaded at one end. Fig. 4.2 shows the set-up the student uses.

The student has a number of composite strips made with two or more layers of wood.

You are **not** required to do this investigation.

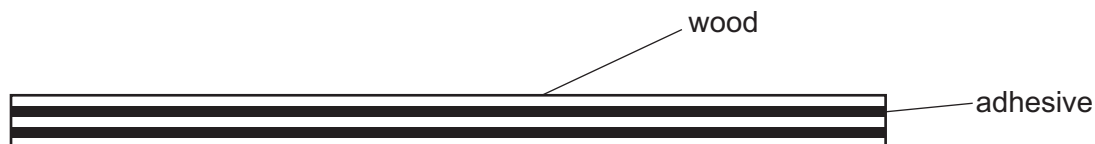

Fig. 4.1

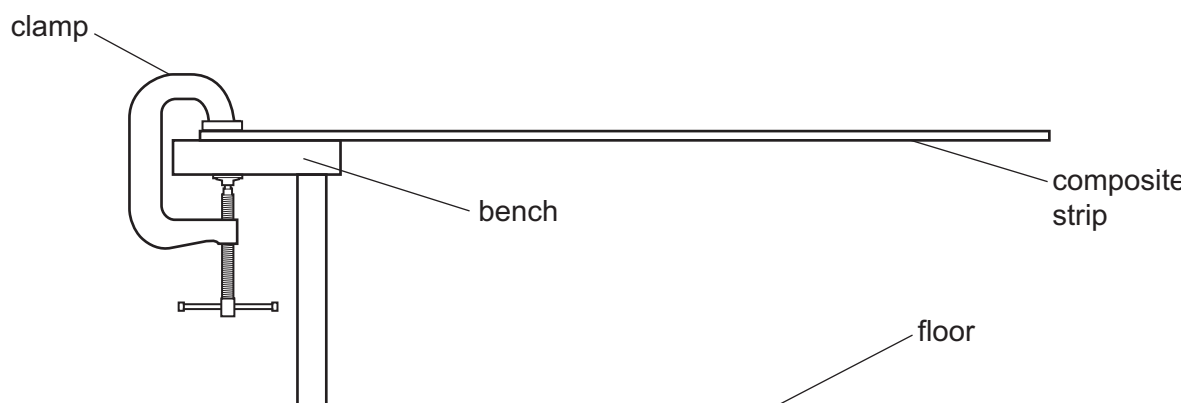

Fig. 4.2

In your plan:

- state the variable that you are testing
- list any additional apparatus that you would use
- explain briefly how to do the investigation
- state the key variables to keep constant
- draw a table, or tables, with column headings, to show how to display your readings (you are **not** required to enter any readings in the table)
- explain how to use your readings to reach a conclusion.

BLANK PAGE

Permission to reproduce items where third-party owned material protected by copyright is included has been sought and cleared where possible. Every reasonable effort has been made by the publisher (UCLES) to trace copyright holders, but if any items requiring clearance have unwittingly been included, the publisher will be pleased to make amends at the earliest possible opportunity.

To avoid the issue of disclosure of answer-related information to candidates, all copyright acknowledgements are reproduced online in the Cambridge Assessment International Education Copyright Acknowledgements Booklet. This is produced for each series of examinations and is freely available to download at www.cambridgeinternational.org after the live examination series.

Cambridge Assessment International Education is part of Cambridge Assessment. Cambridge Assessment is the brand name of the University of Cambridge Local Examinations Syndicate (UCLES), which is a department of the University of Cambridge.