

PHYSICS

9702/13

Paper 1 Multiple Choice

May/June 2017

1 hour 15 minutes

Additional Materials: Multiple Choice Answer Sheet
Soft clean eraser
Soft pencil (type B or HB is recommended)

* 2 8 3 6 5 9 1 2 7 2 *

READ THESE INSTRUCTIONS FIRST

Write in soft pencil.

Do not use staples, paper clips, glue or correction fluid.

Write your name, Centre number and candidate number on the Answer Sheet in the spaces provided unless this has been done for you.

DO NOT WRITE IN ANY BARCODES.

There are **forty** questions on this paper. Answer **all** questions. For each question there are four possible answers **A, B, C** and **D**.

Choose the **one** you consider correct and record your choice in **soft pencil** on the separate Answer Sheet.

Read the instructions on the Answer Sheet very carefully.

Each correct answer will score one mark. A mark will not be deducted for a wrong answer.

Any working should be done in this booklet.

Electronic calculators may be used.

This document consists of **19** printed pages and **1** blank page.

Data

speed of light in free space	$c = 3.00 \times 10^8 \text{ m s}^{-1}$
permeability of free space	$\mu_0 = 4\pi \times 10^{-7} \text{ H m}^{-1}$
permittivity of free space	$\epsilon_0 = 8.85 \times 10^{-12} \text{ F m}^{-1}$ $(\frac{1}{4\pi\epsilon_0} = 8.99 \times 10^9 \text{ m F}^{-1})$
elementary charge	$e = 1.60 \times 10^{-19} \text{ C}$
the Planck constant	$h = 6.63 \times 10^{-34} \text{ J s}$
unified atomic mass unit	$1 \text{ u} = 1.66 \times 10^{-27} \text{ kg}$
rest mass of electron	$m_e = 9.11 \times 10^{-31} \text{ kg}$
rest mass of proton	$m_p = 1.67 \times 10^{-27} \text{ kg}$
molar gas constant	$R = 8.31 \text{ J K}^{-1} \text{ mol}^{-1}$
the Avogadro constant	$N_A = 6.02 \times 10^{23} \text{ mol}^{-1}$
the Boltzmann constant	$k = 1.38 \times 10^{-23} \text{ J K}^{-1}$
gravitational constant	$G = 6.67 \times 10^{-11} \text{ N m}^2 \text{ kg}^{-2}$
acceleration of free fall	$g = 9.81 \text{ m s}^{-2}$

Formulae

uniformly accelerated motion	$s = ut + \frac{1}{2}at^2$ $v^2 = u^2 + 2as$
work done on/by a gas	$W = p\Delta V$
gravitational potential	$\phi = -\frac{Gm}{r}$
hydrostatic pressure	$p = \rho gh$
pressure of an ideal gas	$p = \frac{1}{3}\frac{Nm}{V}\langle c^2 \rangle$
simple harmonic motion	$a = -\omega^2 x$
velocity of particle in s.h.m.	$v = v_0 \cos \omega t$ $v = \pm \omega \sqrt{(x_0^2 - x^2)}$
Doppler effect	$f_o = \frac{f_s v}{v \pm v_s}$
electric potential	$V = \frac{Q}{4\pi\epsilon_0 r}$
capacitors in series	$1/C = 1/C_1 + 1/C_2 + \dots$
capacitors in parallel	$C = C_1 + C_2 + \dots$
energy of charged capacitor	$W = \frac{1}{2}QV$
electric current	$I = Anvq$
resistors in series	$R = R_1 + R_2 + \dots$
resistors in parallel	$1/R = 1/R_1 + 1/R_2 + \dots$
Hall voltage	$V_H = \frac{BI}{ntq}$
alternating current/voltage	$x = x_0 \sin \omega t$
radioactive decay	$x = x_0 \exp(-\lambda t)$
decay constant	$\lambda = \frac{0.693}{t_{\frac{1}{2}}}$

- 1 What is the best estimate of the kinetic energy of a family car travelling at 50 km h^{-1} ?
- A $1.5 \times 10^3 \text{ J}$ B $1.5 \times 10^5 \text{ J}$ C $1.5 \times 10^7 \text{ J}$ D $1.5 \times 10^9 \text{ J}$
- 2 The diagram shows two vectors X and Y. The vectors are perpendicular to one another.

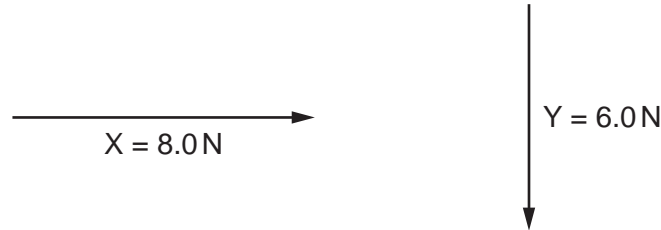

What is the magnitude and direction of vector $(X - Y)$?

- A 10.0 N at an angle of 37° downwards from the direction of X
- B 10.0 N at an angle of 37° upwards from the direction of X
- C 14.0 N at an angle of 53° downwards from the direction of X
- D 14.0 N at an angle of 53° upwards from the direction of X
- 3 Which expression using SI base units is equivalent to the volt?
- A $\text{kg m}^2 \text{s}^{-1} \text{A}^{-1}$
- B $\text{kg m s}^{-2} \text{A}$
- C $\text{kg m}^2 \text{s}^{-1} \text{A}$
- D $\text{kg m}^2 \text{s}^{-3} \text{A}^{-1}$
- 4 A voltage is carefully measured with a high-quality instrument and found to be 2.321 V.
- Two students, using two different methods, conclude that the voltage is 2.33 V and 2.344 V respectively.
- Which statement is correct?
- A 2.33 V is less accurate and less precise than 2.344 V.
- B 2.33 V is less accurate and more precise than 2.344 V.
- C 2.33 V is more accurate and less precise than 2.344 V.
- D 2.33 V is more accurate and more precise than 2.344 V.

- 5 On a planet, a vertically-launched projectile takes 12.5s to return to its starting position. The projectile gains a maximum height of 170m. The planet does not have an atmosphere.

What is the acceleration of free fall on this planet?

- A 2.2 ms^{-2} B 8.7 ms^{-2} C 27 ms^{-2} D 54 ms^{-2}

- 6 A displacement-time graph for a toy car is shown.

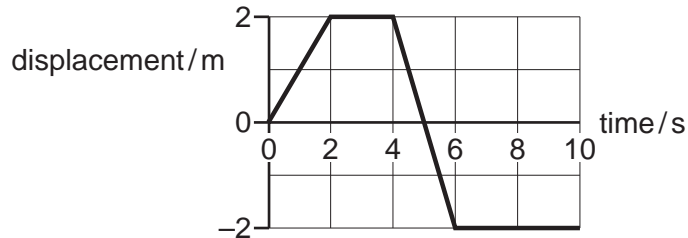

Which graph shows the variation with time of the velocity v of the car?

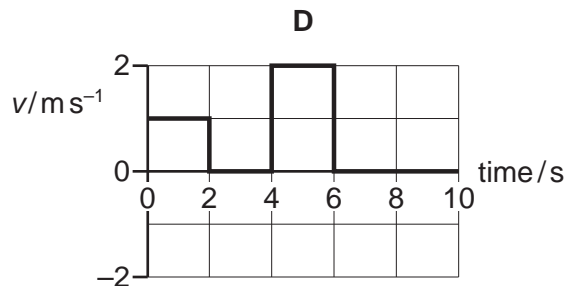
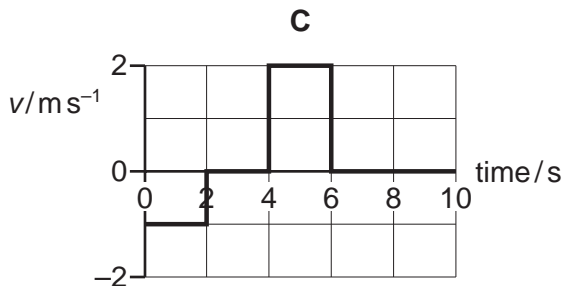
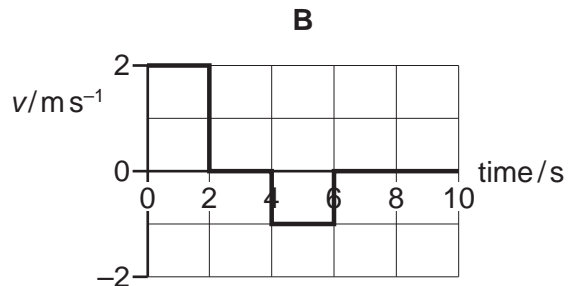
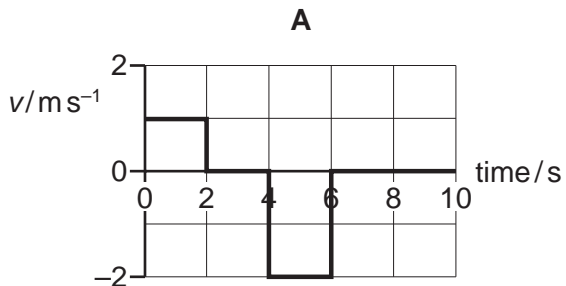

- 7 A driver stops his car in time t by gradually increasing the total braking force on the car. The graph shows the resultant force on the car.

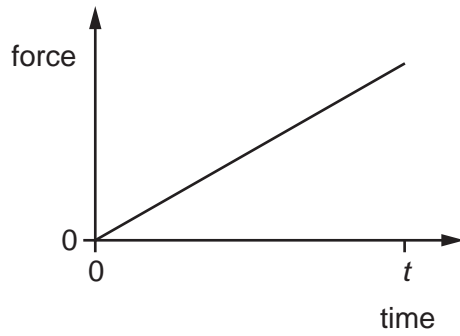

Which graph shows how the speed of the car will vary during this time?

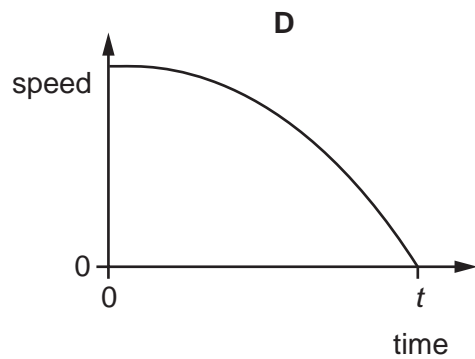
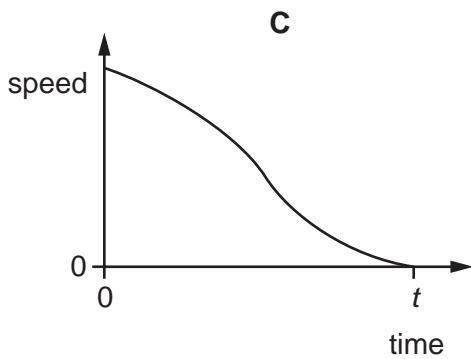
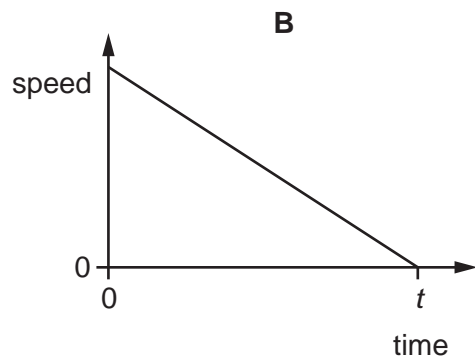
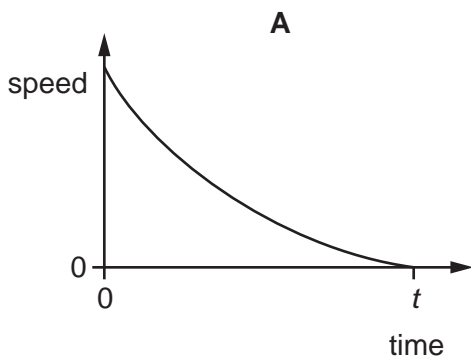

- 8 The graph shows the variation of a quantity y with a quantity x for a body that is falling in air at constant (terminal) velocity in a uniform gravitational field.

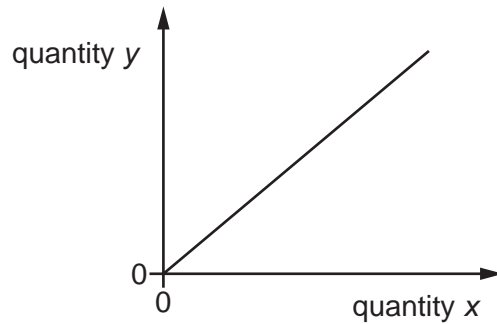

Which quantities could x and y represent?

	x	y
A	air resistance	acceleration
B	loss of height	gain in kinetic energy
C	loss of potential energy	work done against air resistance
D	time	velocity

- 9 A ball of mass 2.0 kg travels horizontally with a speed of 4.0 m s^{-1} . The ball collides with a wall and rebounds in the opposite direction with a speed of 2.8 m s^{-1} . The time of the collision is 150 ms .

What is the average force exerted on the wall?

- A** 16 N **B** 37 N **C** 53 N **D** 91 N
- 10 An ice-hockey puck of mass 150 g moves with an initial speed of 2.0 m s^{-1} along the surface of an ice rink.

The puck slides a distance of 30 m in a straight line before stopping.

What is the average frictional force acting on the puck?

- A** 0.010 N **B** 0.020 N **C** 0.067 N **D** 0.44 N

- 11 A uniform beam of mass 1.4 kg is pivoted at P as shown. The beam has a length of 0.60 m and P is 0.20 m from one end. Loads of 3.0 kg and 6.0 kg are suspended 0.35 m and 0.15 m from the pivot as shown.

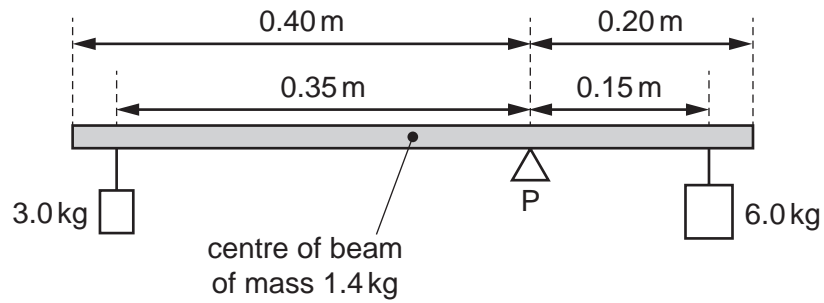

What is the torque that must be applied to the beam in order to maintain it in equilibrium?

- A 0.010 Nm B 0.10 Nm C 0.29 Nm D 2.8 Nm
- 12 An air bubble is rising through a liquid at a constant speed. The forces on it are the upthrust U , the viscous drag D and its weight W .

Which diagram shows the directions and relative sizes of the forces?

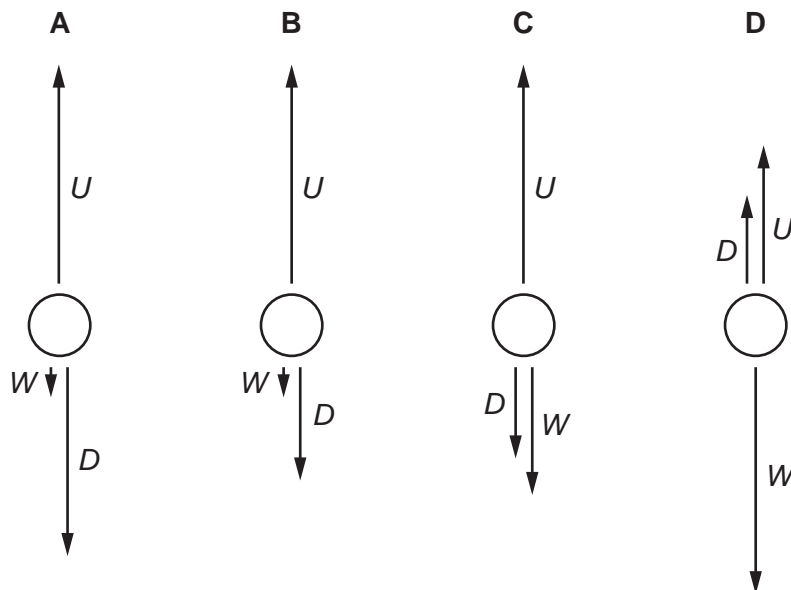

- 13 The diagram represents a sphere under water. P, Q, R and S are forces acting on the sphere due to the pressure of the water.

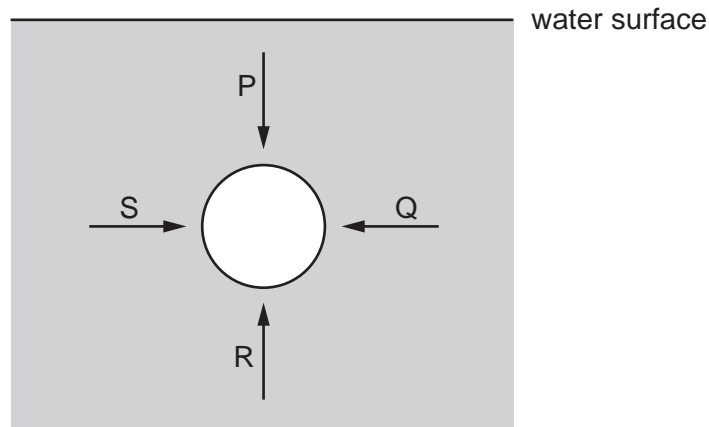

Each force acts perpendicularly to the sphere's surface. P and R act in opposite directions vertically. Q and S act in opposite directions horizontally.

Which information about the magnitudes of the forces is correct?

- A $P < R$ and $S = Q$
 B $P > R$ and $S = Q$
 C $P = R$ and $S = Q$ and $P < S$
 D $P = R$ and $S = Q$ and $P = S$
- 14 The first column in the table gives four examples of work being done. The second column gives more detail of the action.

Which row is **not** correct?

	example	detail
A	a girl dives from a diving board into a swimming pool	work is done by the girl against the gravitational field as she falls
B	a man pushes a car along a level road	work is done by the man against friction
C	an electron is accelerated towards a positively charged plate	work is done on the electron by the electric field of the plate
D	a piston is pushed outwards as a gas expands	work is done on the atmosphere by the gas

- 15 A steam turbine is used to drive a generator. The input power to the turbine is P_I and the output power is P_O . The power loss in the turbine is P_L , as shown below.

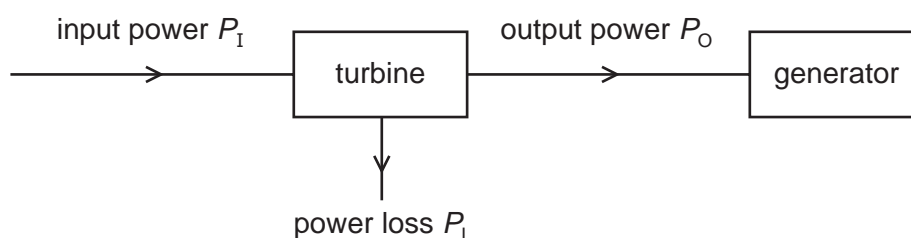

What is the efficiency of the turbine?

- A $\frac{P_L}{P_O}$ B $\frac{P_I}{P_O}$ C $\frac{P_L}{P_I}$ D $\frac{P_O}{P_I}$
- 16 A constant force pushes a block along a horizontal frictionless surface. The block moves from rest through a fixed distance.

What is the relationship between the final speed v of the block and its mass m ?

- A $\sqrt{v} \propto \frac{1}{m}$ B $v \propto \sqrt{m}$ C $v \propto \frac{1}{\sqrt{m}}$ D $\sqrt{v} \propto m$
- 17 A man has a mass of 80 kg. He ties himself to one end of a rope which passes over a single fixed pulley. He pulls on the other end of the rope to lift himself up at an average speed of 50 cm s^{-1} .

What is the average useful power at which he is working?

- A 40 W B 0.39 kW C 4.0 kW D 39 kW
- 18 Two wires with the same Young modulus E and cross-sectional area A , but different lengths L , are subject to different tensile forces F . The extension e of each wire is the same.

The column headings in the table show four different quantities.

Which quantities have the same value and which quantities have different values for the two wires?

	$\frac{FL}{e}$	$\frac{Ae}{L}$	$\frac{E}{FL}$
A	different	different	same
B	different	same	same
C	same	different	different
D	same	different	same

- 19 Two springs X and Y stretch elastically. The graphs show the variation with extension x of the force F applied to each spring.

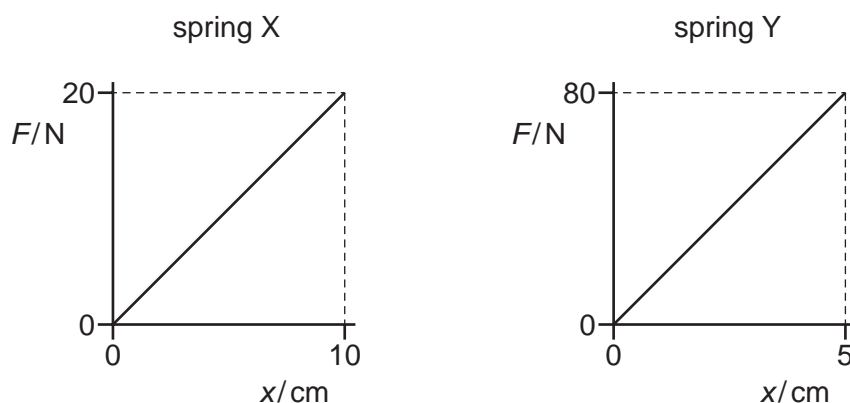

Which statement is correct?

- A** When each spring is given the same extension, the energy stored in Y is 4 times the energy stored in X.
- B** When each spring is given the same extension, the energy stored in Y is 8 times the energy stored in X.
- C** When the same force is applied to each spring, the energy stored in Y is 4 times the energy stored in X.
- D** When the same force is applied to each spring, the energy stored in Y is 8 times the energy stored in X.
- 20 The diagram shows the force-extension graph for a steel wire, up to its breaking point.

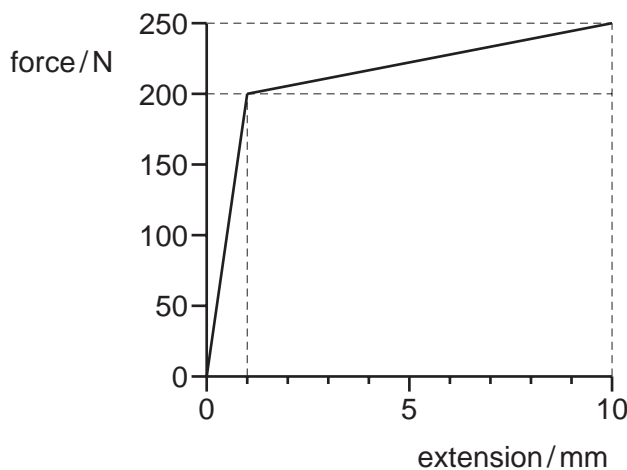

What is the best estimate of the work done to break the wire?

- A** 2.1 J **B** 2.3 J **C** 2.4 J **D** 2.5 J

21 Which statement about electromagnetic waves in a vacuum is correct?

- A Amplitude is inversely proportional to velocity.
- B Frequency is inversely proportional to wavelength.
- C Intensity is proportional to amplitude.
- D Velocity is proportional to wavelength.

22 A transverse wave travels along a rope. The graph shows the variation of the displacement of the particles in the rope with distance along it at a particular instant.

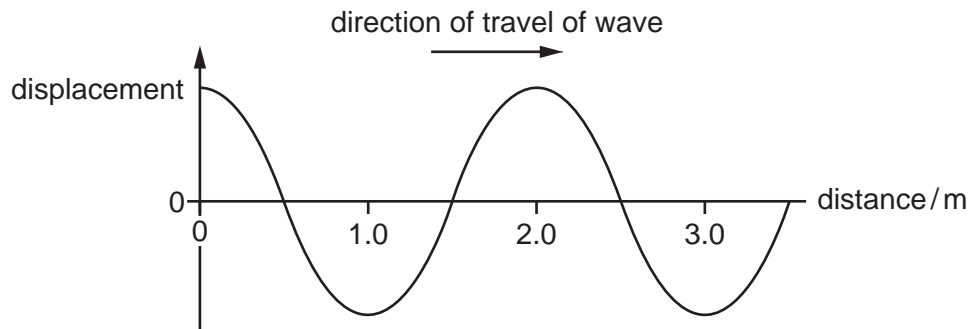

At which distance along the rope do the particles have maximum upwards velocity?

- A 0.5 m
- B 1.0 m
- C 1.5 m
- D 2.0 m

23 A trace is shown on the screen of a cathode-ray oscilloscope (c.r.o.).

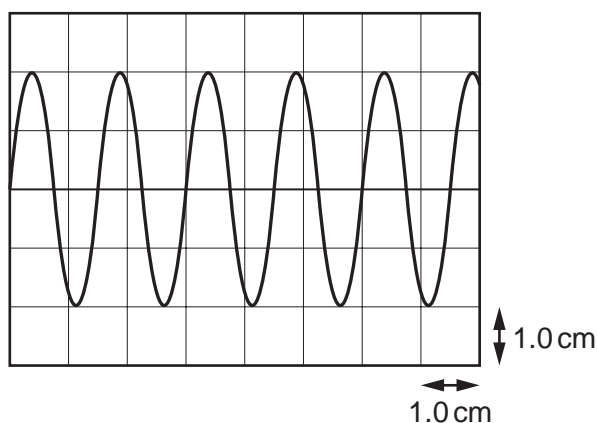

The time-base setting is 2.5 ms cm^{-1} and the Y-gain is 2.0 V cm^{-1} .

What is the frequency and the amplitude of the waveform displayed by the c.r.o.?

	frequency / Hz	amplitude / V
A	0.00375	4.0
B	0.00375	8.0
C	267	4.0
D	267	8.0

24 A high-speed train approaches a stationary observer at a speed of 80 ms^{-1} . The train's horn emits a sound of frequency 250 Hz.

The speed of sound is 340 ms^{-1} .

What is the observed frequency of the sound from the horn?

- A** 190 Hz **B** 200 Hz **C** 310 Hz **D** 330 Hz

25 Which row shows a correct frequency in Hz for each of the four principal radiations?

	X-rays	ultraviolet	microwaves	infra-red
A	10^{10}	10^{14}	10^{18}	10^{15}
B	10^{14}	10^{18}	10^{15}	10^{10}
C	10^{15}	10^{10}	10^{14}	10^{18}
D	10^{18}	10^{15}	10^{10}	10^{14}

- 26 A pipe of length 100 cm is open at both ends. A loudspeaker situated at one end of the pipe can emit sound of different wavelengths.

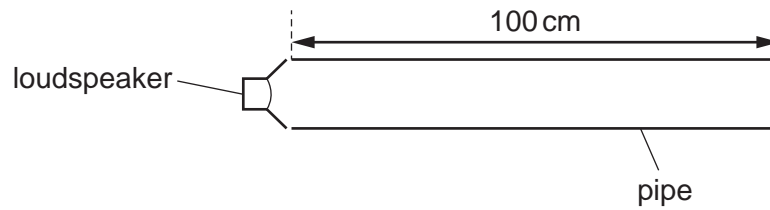

At which wavelength can a stationary wave be produced in the pipe?

- A** 50 cm **B** 75 cm **C** 150 cm **D** 300 cm
- 27 Monochromatic light is incident on a diffraction grating and a diffraction pattern is observed.

Which row shows possible effects of replacing the grating with one that has twice as many lines per millimetre?

	number of orders of diffraction visible	angle between first and second orders of diffraction
A	decreases	decreases
B	decreases	increases
C	increases	decreases
D	increases	increases

- 28 Monochromatic light of wavelength λ is incident on two narrow slits S_1 and S_2 , a small distance apart. A series of bright and dark fringes are observed on a screen a long distance away from the slits.

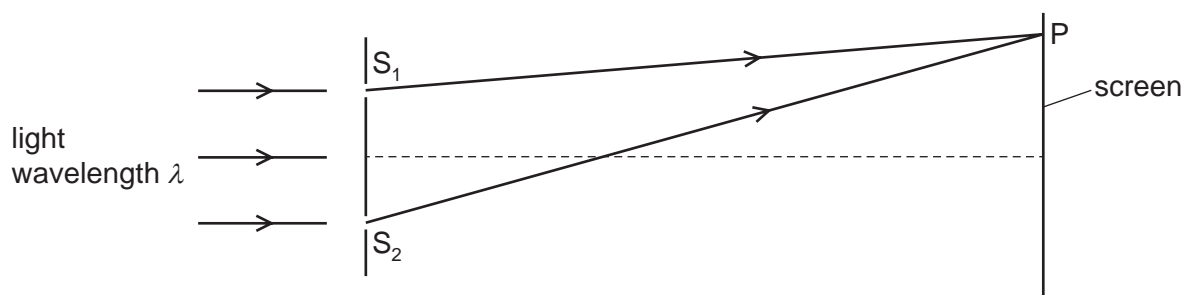

The n th **dark** fringe from the central bright fringe is observed at point P on the screen.

Which equation is correct for all positive values of n ?

- A $S_2P - S_1P = \frac{n\lambda}{2}$
- B $S_2P - S_1P = n\lambda$
- C $S_2P - S_1P = (n - \frac{1}{2})\lambda$
- D $S_2P - S_1P = (n + \frac{1}{2})\lambda$
- 29 A dipole is a pair of charges of equal magnitude, one negative and one positive. The electric field of a dipole is shown below.

In which direction does the force act on an electron when at point X?

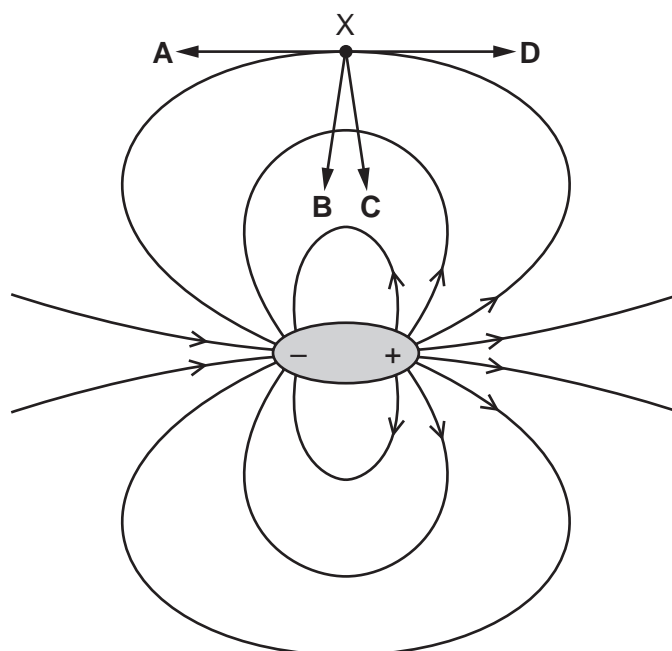

30 In a uniform electric field, which statement is correct?

- A All charged particles experience the same force.
- B All charged particles move with the same velocity.
- C All electric field lines are directed towards positive charges.
- D All electric field lines are parallel.

31 Two metal plates are a distance of 30 cm apart in a vacuum.

A current exists between the two plates consisting of electrons moving at a constant speed of $1.5 \times 10^6 \text{ m s}^{-1}$.

At any instant, there is always just one electron travelling between the plates.

What is the current between the plates?

- A $3.2 \times 10^{-26} \text{ A}$
- B $8.0 \times 10^{-13} \text{ A}$
- C $1.6 \times 10^{-12} \text{ A}$
- D $2.0 \times 10^{-7} \text{ A}$

32 The diagram shows a portable generator connected by cables to floodlights. The generator produces a current of 10 A at a constant potential difference (p.d.) of 240 V.

The total resistance of the cables is 2Ω .

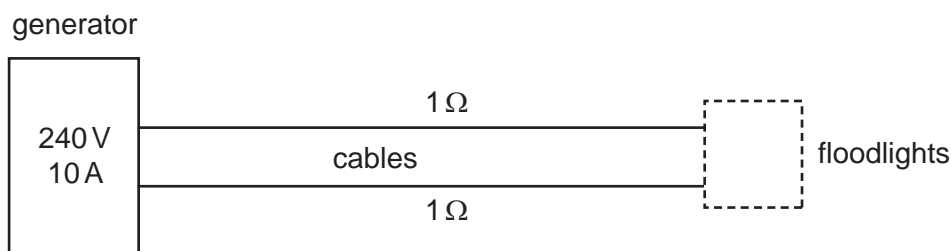

What is the p.d. V across, and the power P delivered to, the floodlights?

	V/V	P/W
A	220	2000
B	220	2200
C	230	2000
D	230	2300

- 33 A metal cube with sides of length a has electrical resistance R between opposite faces.

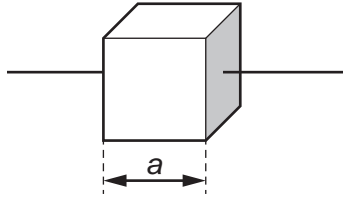

What is the resistance between the opposite faces of a cube of the same metal with sides of length $3a$?

- A $9R$ B $3R$ C $\frac{R}{3}$ D $\frac{R}{9}$

- 34 A graph of potential difference (p.d.) V across a cell against current I in the cell is shown.

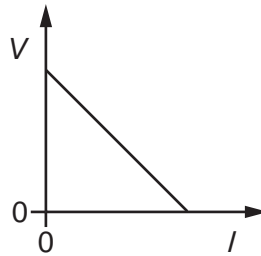

As the cell reaches the end of its useful life, its internal resistance increases and its electromotive force (e.m.f.) decreases.

Which diagram shows a graph of V against I for the cell nearing the end of its useful life?

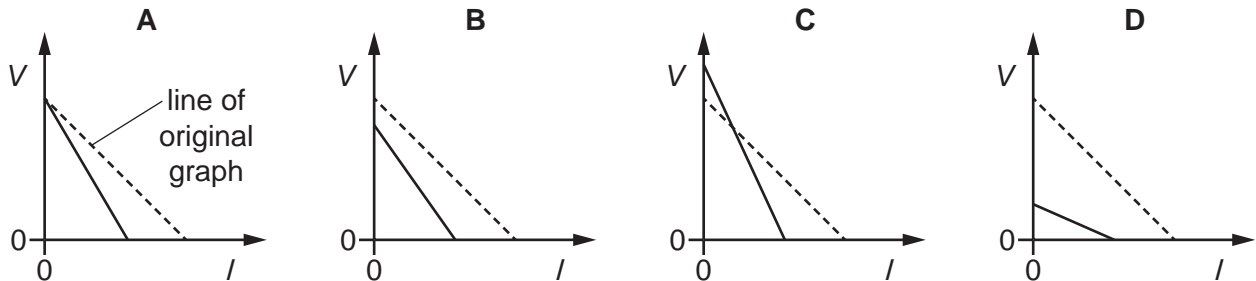

- 35 A 20V d.c. supply is connected to a circuit consisting of five resistors L, M, N, P and Q.

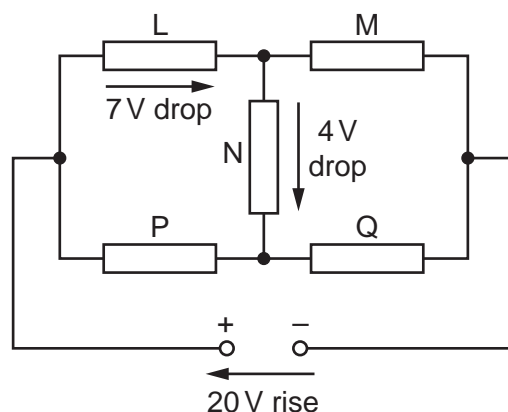

There is a potential drop of 7V across L and a further 4V potential drop across N.

What are the potential drops across M, P and Q?

	potential drop across M/V	potential drop across P/V	potential drop across Q/V
A	9	7	13
B	13	7	13
C	13	11	9
D	17	3	17

- 36 A potential divider circuit consists of a cell of negligible internal resistance in series with two variable resistors of resistances R_1 and R_2 . The potential difference (p.d.) across the cell is V_0 . The p.d. at the output is V .

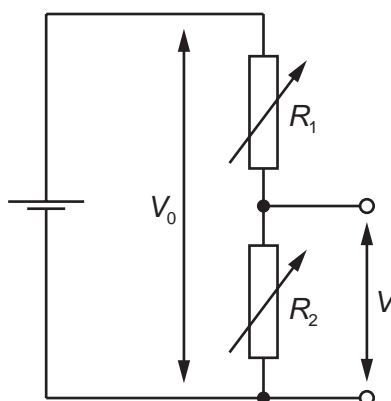

Which statement is correct?

- A** When R_1 increases, it takes a greater proportion of V_0 , so V decreases.
B When R_1 increases, the current through R_1 and R_2 decreases, so V increases.
C When R_2 decreases, it takes a smaller proportion of V_0 , so V increases.
D When R_2 increases, the current through R_1 and R_2 decreases, so V decreases.

- 37 A nucleus of uranium-238, ${}_{92}^{238}\text{U}$, decays in a series of steps to form a nucleus of lead-206, ${}_{82}^{206}\text{Pb}$, as shown.

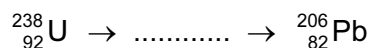

An α -particle or a β^- particle is emitted during each step.

What is the total number of β^- particles that are emitted?

- A 6 B 8 C 10 D 16
- 38 Which statement about α -particles is correct?
- A α -particles emitted from a single radioactive isotope have a continuous distribution of energies.
- B α -particles have less ionising power than β -particles.
- C The charge of an α -particle is $+1.60 \times 10^{-19} \text{C}$.
- D The speeds of α -particles can be as high as $1.5 \times 10^7 \text{ms}^{-1}$.
- 39 The nuclear equation shown has a term missing.

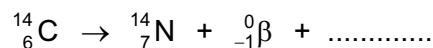

What is represented by the missing term?

- A an antineutrino
- B an electron
- C a neutrino
- D a positron
- 40 Which particle is a fundamental particle?
- A electron
- B hadron
- C neutron
- D proton

BLANK PAGE

Permission to reproduce items where third-party owned material protected by copyright is included has been sought and cleared where possible. Every reasonable effort has been made by the publisher (UCLES) to trace copyright holders, but if any items requiring clearance have unwittingly been included, the publisher will be pleased to make amends at the earliest possible opportunity.

To avoid the issue of disclosure of answer-related information to candidates, all copyright acknowledgements are reproduced online in the Cambridge International Examinations Copyright Acknowledgements Booklet. This is produced for each series of examinations and is freely available to download at www.cie.org.uk after the live examination series.

Cambridge International Examinations is part of the Cambridge Assessment Group. Cambridge Assessment is the brand name of University of Cambridge Local Examinations Syndicate (UCLES), which is itself a department of the University of Cambridge.