



Cambridge International Examinations
Cambridge International General Certificate of Secondary Education

PHYSICS

0625/12

Paper 1 Multiple Choice (Core)

October/November 2017

45 minutes

Additional Materials: Multiple Choice Answer Sheet
Soft clean eraser
Soft pencil (type B or HB recommended)



READ THESE INSTRUCTIONS FIRST

Write in soft pencil.

Do not use staples, paper clips, glue or correction fluid.

Write your name, Centre number and candidate number on the Answer Sheet in the spaces provided unless this has been done for you.

DO NOT WRITE IN ANY BARCODES.

There are **forty** questions on this paper. Answer **all** questions. For each question there are four possible answers **A, B, C** and **D**.

Choose the **one** you consider correct and record your choice in **soft pencil** on the separate Answer Sheet.

Read the instructions on the Answer Sheet very carefully.

Each correct answer will score one mark. A mark will not be deducted for a wrong answer.

Any rough working should be done in this booklet.

Electronic calculators may be used.

Take the weight of 1.0 kg to be 10 N (acceleration of free fall = 10 m/s^2).

bestexamhelp.com

The syllabus is approved for use in England, Wales and Northern Ireland as a Cambridge International Level 1/Level 2 Certificate.

This document consists of **19** printed pages and **1** blank page.

- 1 A student investigates the rate of flow of oil through a funnel.

The diagrams show the experiment and the volume of oil in the measuring cylinder at the start of the experiment, and one minute later.

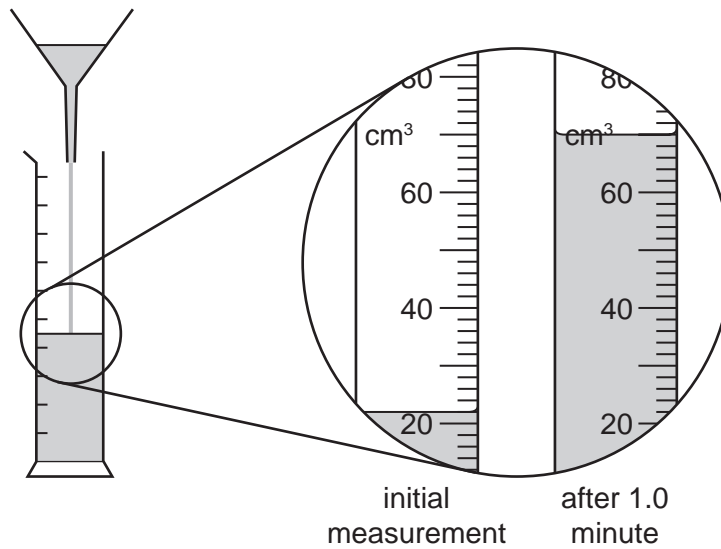

What is the rate of flow of oil through the funnel during the one minute?

- A** $0.73 \text{ cm}^3/\text{s}$ **B** $0.80 \text{ cm}^3/\text{s}$ **C** $44 \text{ cm}^3/\text{s}$ **D** $48 \text{ cm}^3/\text{s}$
- 2 The graph represents the motion of a vehicle.

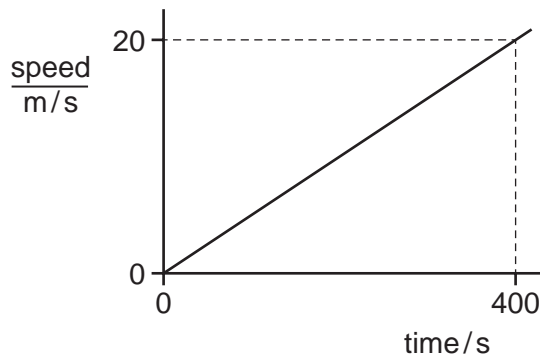

What is the distance travelled by the vehicle in 400 s?

- A** 20 m **B** 400 m **C** 4000 m **D** 8000 m

- 3 The speed-time graph represents the motion of an object.

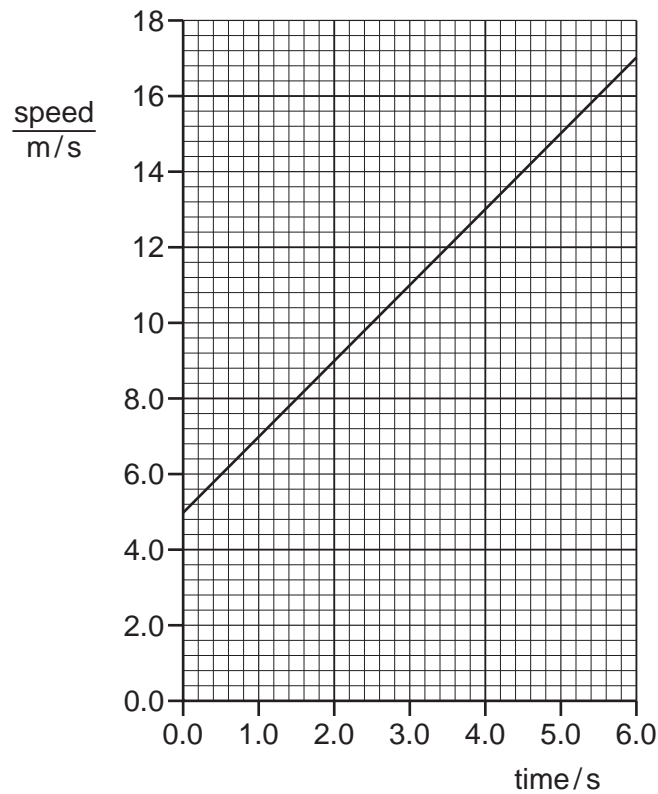

What is the average speed of the object?

- A** 2.0m/s **B** 6.0m/s **C** 8.5m/s **D** 11m/s
- 4 A spring is stretched by hanging a piece of metal from it.

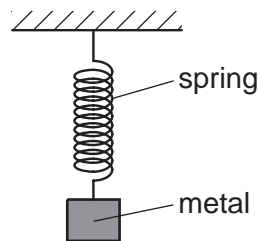

Which name is given to the force that stretches the spring?

- A** friction
B mass
C pressure
D weight

- 5 The graph shows how weight varies with mass on planet P and on planet Q.

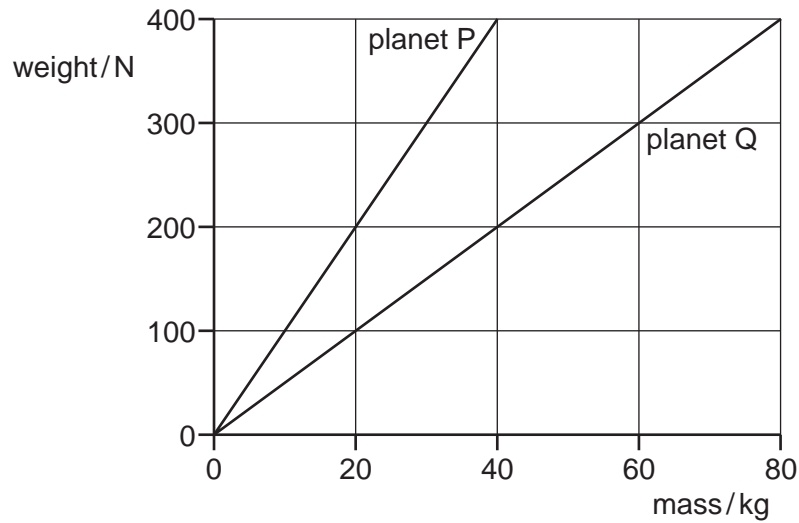

An object weighs 400 N on planet P. The object is taken to planet Q.

Which row is correct?

	mass of object on planet Q/kg	weight of object on planet Q/N
A	40	200
B	40	400
C	80	200
D	80	400

- 6 What is needed to determine the density of a regularly shaped block?
- A** a balance and a beaker
 - B** a balance and a ruler
 - C** a measuring cylinder and a beaker
 - D** a measuring cylinder and a ruler

7 The diagram shows an aircraft flying in a straight horizontal line at constant speed.

W is the weight of the aircraft.

L is the lift (upward force) due to air flow over the wings.

T is the thrust force due to the engine.

D is the air resistance (drag).

The diagram shows the direction of these forces.

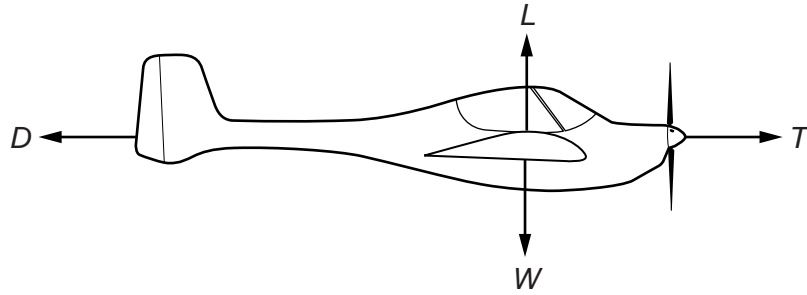

What are the relationships between the forces?

- A $L = W$ and $T = D$
- B $L = W$ and T is greater than D
- C L is greater than W and $T = D$
- D L is greater than W and T is greater than D

- 8 A pivoted beam supports a load P at one end and a load Q at the other end.

The weight of the beam can be ignored.

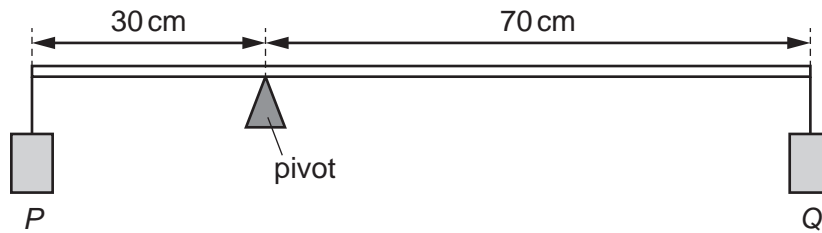

The beam is balanced.

Which row gives possible values for P and for Q ?

	P/N	Q/N
A	21	7
B	21	9
C	30	10
D	30	70

- 9 Each diagram shows a metal plate with four parallel forces acting on it. These are the only forces acting on the plates.

In which diagram is the plate in equilibrium?

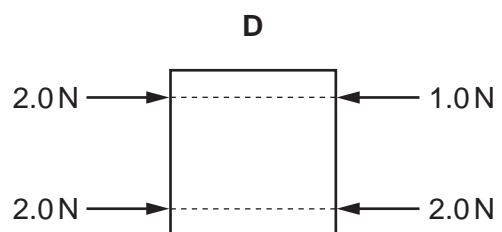
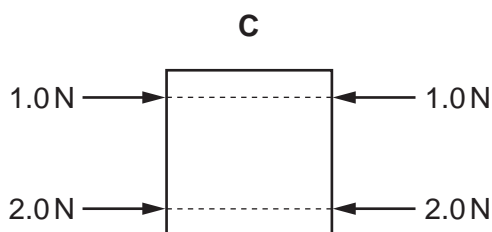
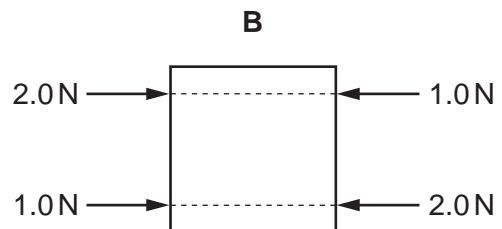
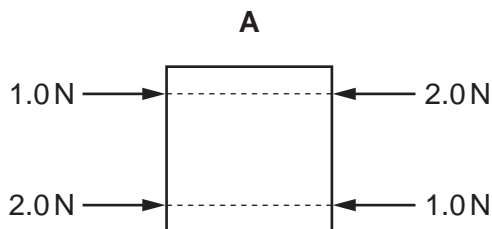

- 10 A load is attached to the end of a spring. A student pulls the load down from its rest position and releases it. It oscillates vertically and eventually comes to rest.

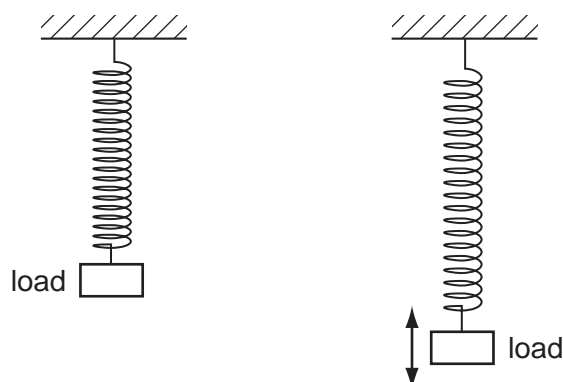

Which row gives the type of energy transferred to the apparatus, and the type of energy to which this has then been transferred when the load comes to rest?

	type of energy transferred to the apparatus	type of energy to which this has then been transferred when the load comes to rest
A	elastic energy in the spring	chemical energy in the spring and in the air
B	elastic energy in the spring	thermal energy in the spring and in the air
C	gravitational potential energy in the load	chemical energy in the spring and in the air
D	gravitational potential energy in the load	thermal energy in the spring and in the air

- 11 A student runs up a flight of stairs.

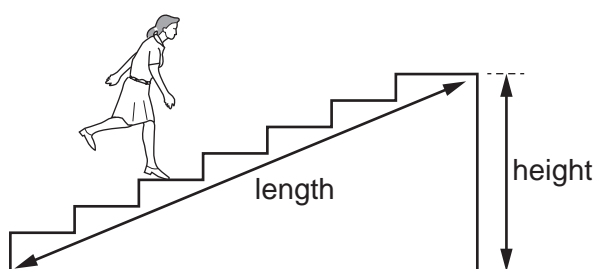

Which information is **not** needed to calculate the rate at which the student is doing work against gravity?

- A** the height of the flight of stairs
- B** the length of the flight of stairs
- C** the time taken to run up the stairs
- D** the weight of the student

12 A book has a mass of 400 g.

One of its surfaces measures $0.10\text{ m} \times 0.20\text{ m}$. This surface is in contact with a table.

The gravitational field strength g is 10 N/kg .

What is the pressure exerted on the table due to the book?

- A** 0.08 N/m^2 **B** 8.0 N/m^2 **C** 20 N/m^2 **D** 200 N/m^2

13 The diagram shows a simple mercury barometer.

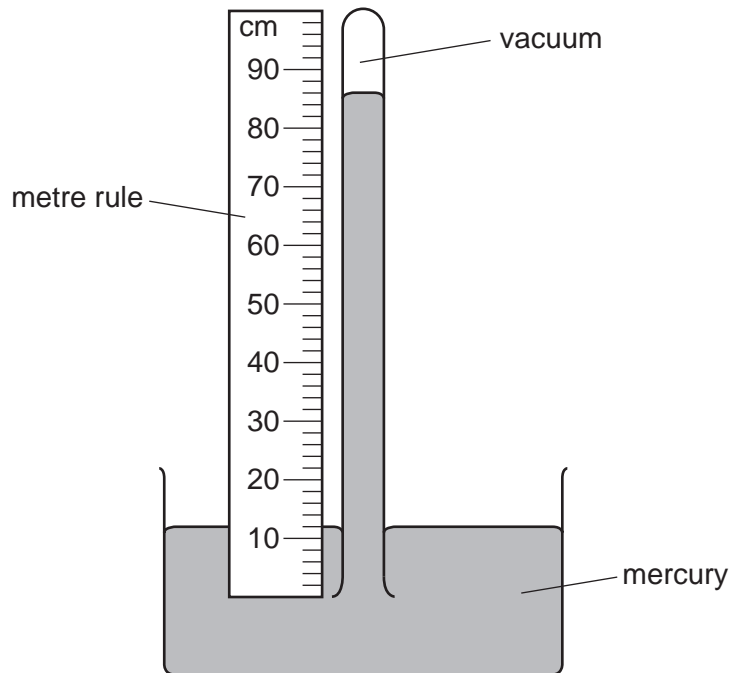

Which length is used to find the value of atmospheric pressure?

- A** 12 cm **B** 74 cm **C** 86 cm **D** 100 cm

14 A pollen grain in a beaker of still water is viewed through a microscope.

Which diagram shows the most likely movement of the pollen grain?

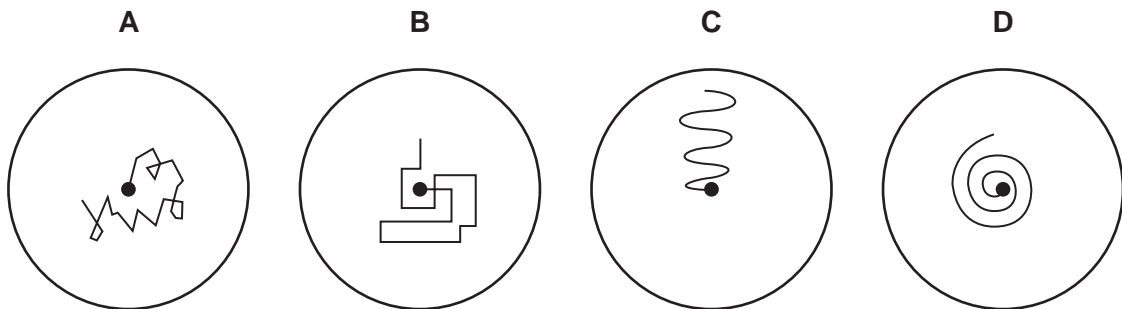

- 15 The diagram shows an air-filled rubber toy. A child sits on the toy and its volume decreases. The temperature of the air in the toy does not change.

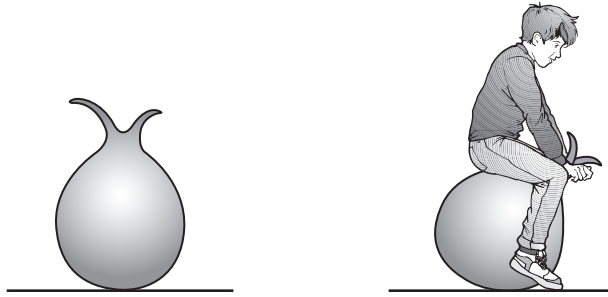

How does the air pressure in the toy change and why?

	pressure	reason
A	decreases	air molecules move more slowly
B	decreases	air molecules strike the rubber less frequently
C	increases	air molecules move more quickly
D	increases	air molecules strike the rubber more frequently

- 16 Which row identifies the fixed points on the Celsius scale?

	lower fixed point	upper fixed point
A	boiling point of mercury	melting point of pure ice
B	boiling point of pure water	melting point of pure ice
C	melting point of mercury	boiling point of pure water
D	melting point of pure ice	boiling point of pure water

- 17 The diagram shows an electric heater being used to heat a beaker of water and an identical beaker containing oil. Both are heated for one minute.

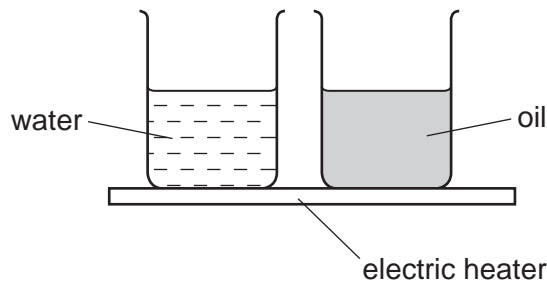

The temperature of the water and the temperature of the oil increase steadily. The increase in temperature of the oil is much greater than that of the water.

Why is this?

- A Oil has a higher boiling point than water.
 - B Oil has a lower boiling point than water.
 - C The oil has a larger thermal capacity than the water.
 - D The oil has a smaller thermal capacity than the water.
- 18 Which statement about the direction of a change of state is correct?
- A Evaporation is the reverse process to boiling.
 - B Evaporation is the reverse process to condensation.
 - C Evaporation is the reverse process to melting.
 - D Evaporation is the reverse process to solidification.

19 Three cups are made from the same insulating material.

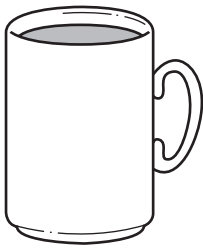

cup 1

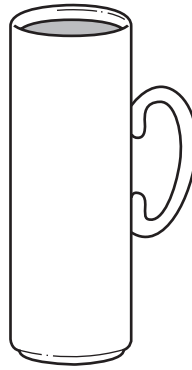

cup 2

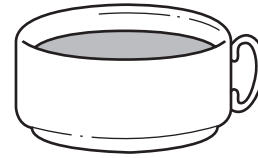

cup 3

The cups are each filled with the same volume of hot tea.

In which cup does the tea cool most quickly and in which cup does it cool most slowly?

	most quickly	most slowly
A	1	3
B	2	1
C	3	2
D	3	1

20 Why does a balloon filled with hot air rise?

- A** Cold air is less dense than hot air.
- B** Cold air is more dense than hot air.
- C** Heat rises.
- D** The density of the balloon is greater than the density of the surrounding gas.

21 A wave moves along the surface of water.

What is the wavelength of the wave?

- A** the distance between one crest and the next crest
- B** the distance that a crest moves along the surface in one second
- C** the distance that a particle of water moves up and down
- D** the number of waves that pass a fixed point in one second

22 The diagram represents plane wavefronts of a water wave about to strike a solid barrier.

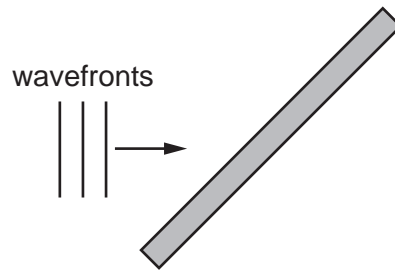

Which diagram shows the position of the wavefronts after reflection at the barrier?

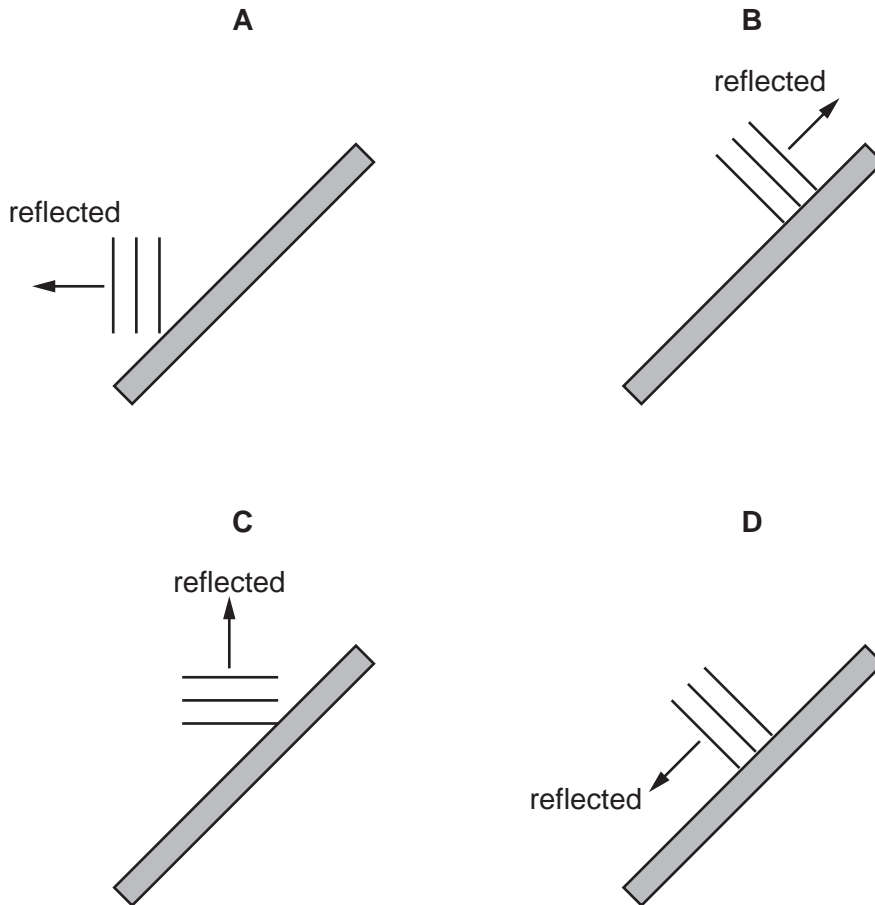

23 The diagram shows an object O in front of a thin converging lens of focal length f .

At which point will the lens form a sharp image of the object?

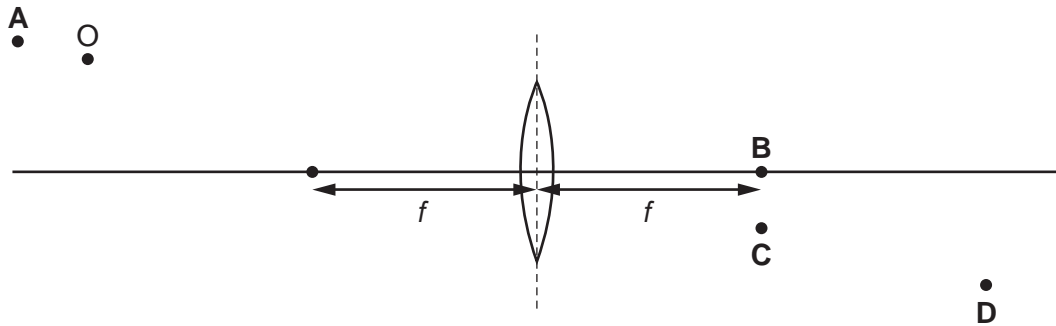

24 The diagram shows light travelling from glass to air.

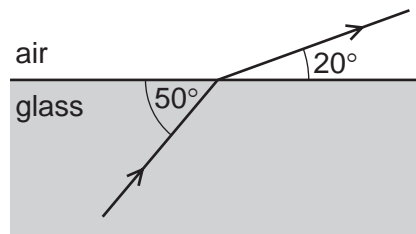

What is the angle of refraction for this ray of light?

- A 20° B 40° C 50° D 70°

25 Which piece of equipment is designed to produce a type of electromagnetic wave?

- A electric fire
 B electric generator
 C electric motor
 D electromagnet

26 What is ultrasound?

- A sound waves that are so loud that they damage human hearing
 B sound waves that are too high-pitched for humans to hear
 C sound waves that are too low-pitched for humans to hear
 D sound waves that are too quiet for humans to hear

27 A student finds that it takes sound 0.33 seconds to travel 100 metres.

From this information, what is the speed of sound?

- A 30 m/s B 60 m/s C 300 m/s D 600 m/s

28 A train of steel nails and a train of iron nails hang from a strong magnet.

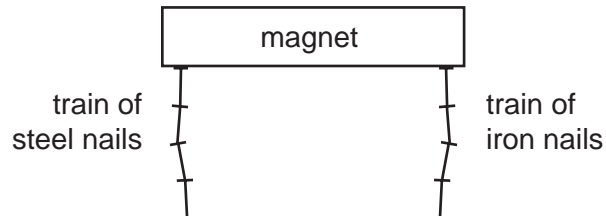

The trains are then carefully removed from the magnet.

What happens to the trains?

- A Both trains fall apart.
 B Both trains stay together.
 C Only the train of iron nails falls apart.
 D Only the train of steel nails falls apart.

29 Two circuits are set up as shown. The iron rods are placed close together and are able to move.

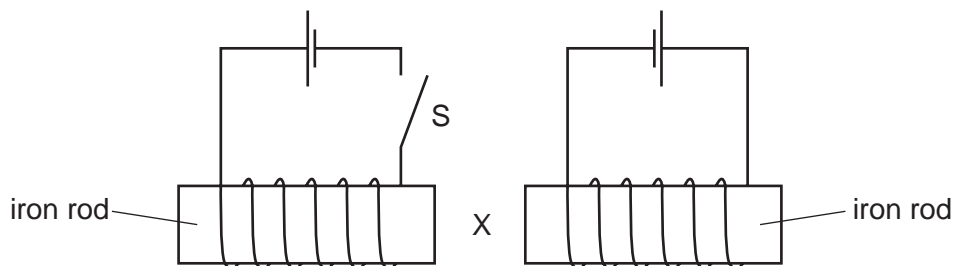

What happens to the size of the gap at X when switch S is closed?

- A It decreases.
 B It decreases then increases.
 C It increases.
 D It does not change.

30 Which circuit can be used to determine the resistance of resistor R?

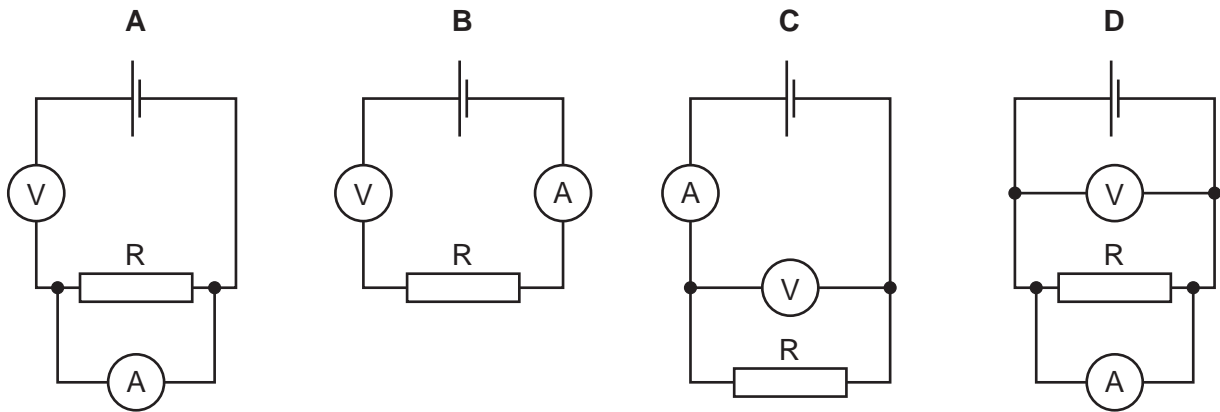

31 A wire has a resistance R .

A second wire made from the same metal has double the length and has double the diameter of the first wire.

What is the resistance of the second wire?

- A $\frac{R}{2}$ B R C $4R$ D $8R$

32 The circuit diagram shows a $4.0\ \Omega$ resistor and an $8.0\ \Omega$ resistor connected to a 6.0 V battery.

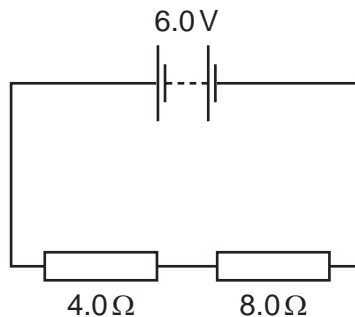

What is the potential difference (p.d.) across the $4.0\ \Omega$ resistor?

- A 0.5 V B 2.0 V C 4.0 V D 6.0 V

- 33 The diagram shows a motor and a light-dependent resistor (LDR) connected in a circuit.

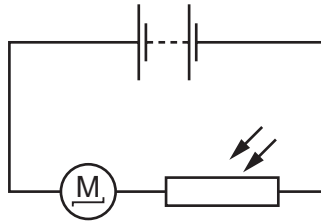

Which change decreases the current in the motor so that it turns more slowly?

- A connecting a resistor in parallel with the LDR
 - B connecting a resistor in series with the LDR
 - C exchanging the positions of the motor and the LDR in the circuit
 - D increasing the brightness of the light falling on the LDR
- 34 The diagram shows a circuit with a fixed resistor connected in series with a thermistor and an ammeter.

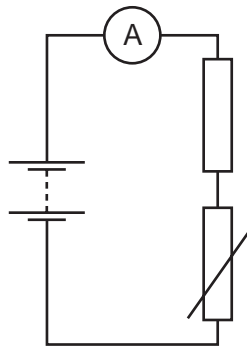

Which row shows how temperature change affects the resistance of the thermistor and the current in the circuit?

	temperature	resistance of thermistor	current in circuit
A	decreases	decreases	increases
B	decreases	increases	decreases
C	increases	decreases	decreases
D	increases	increases	increases

35 An appliance is connected to a mains supply. Its circuit also contains a switch and a fuse.

Which circuit shows the fuse in the correct position?

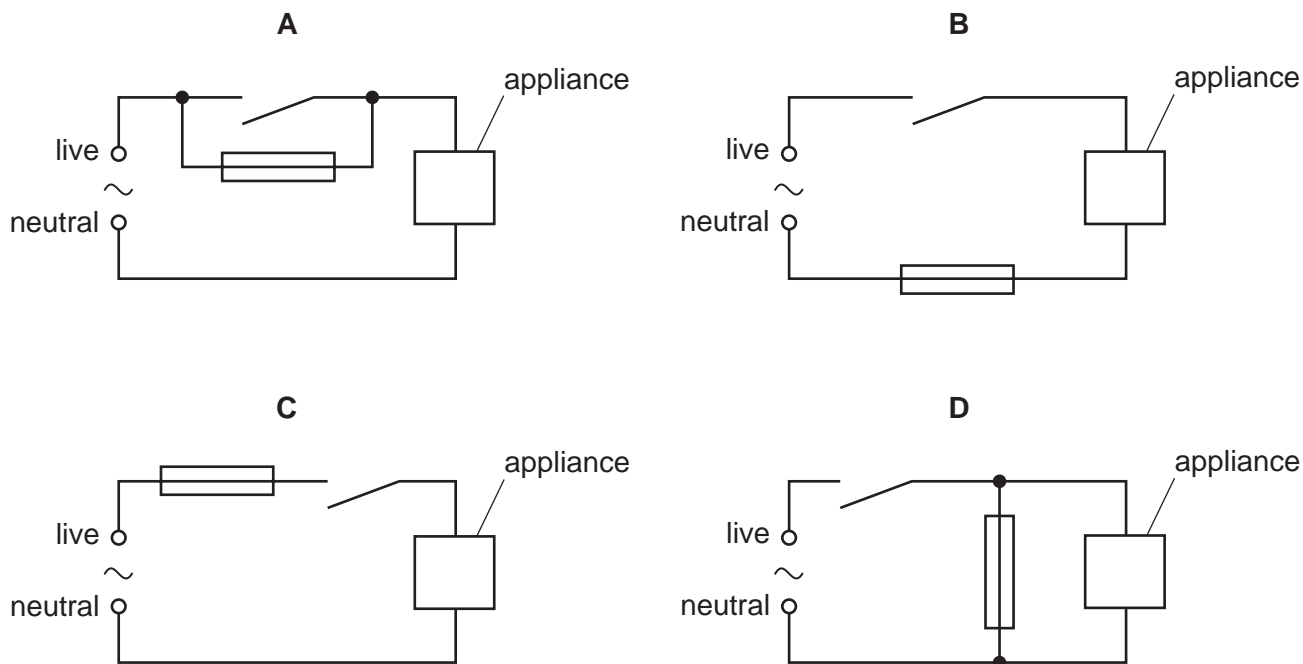

36 The diagram shows a bar magnet and a coil of wire. The bar magnet is moved at the same speed in each experiment.

In which situation is the largest electromotive force (e.m.f.) induced?

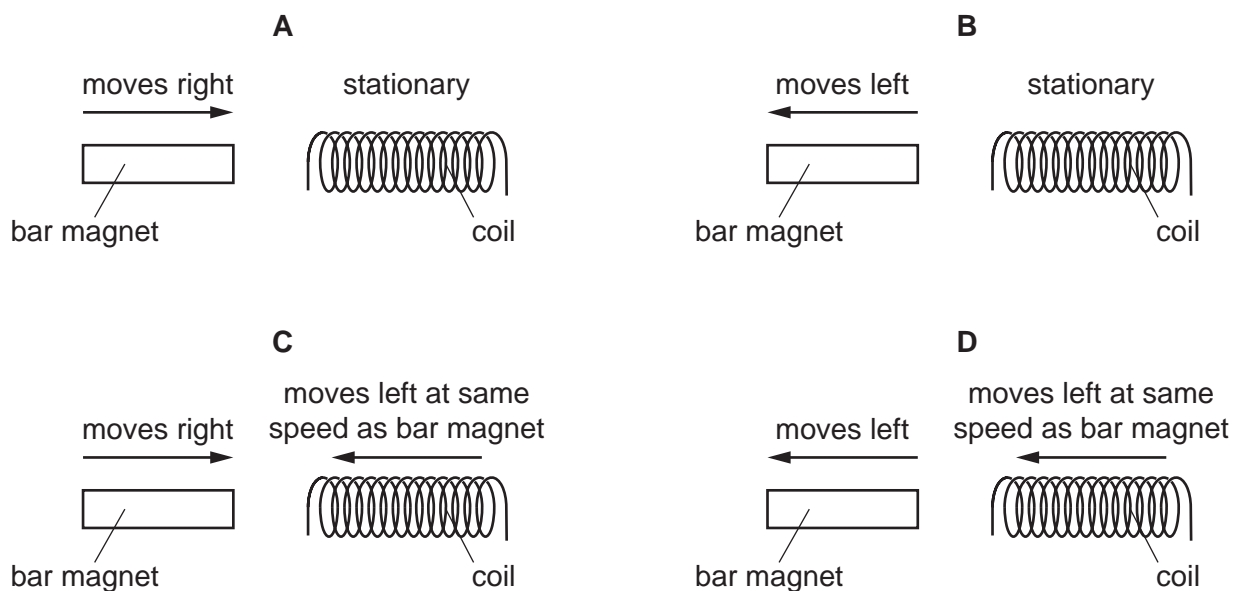

- 37 Diagram 1 shows a wire carrying an electric current. The wire is between the poles of a magnet. The current and the magnetic field produce a force on the wire which is upwards, as shown.

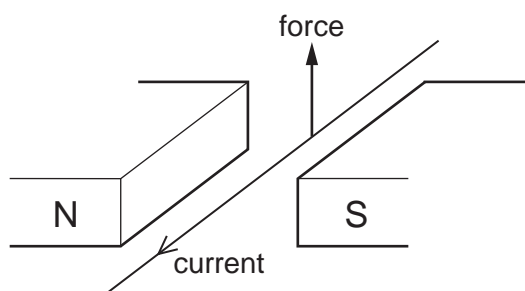

diagram 1

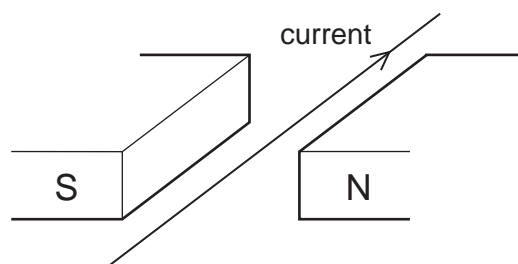

diagram 2

The magnetic poles and the current are now both reversed, as in diagram 2.

In which direction is the force on the wire in diagram 2?

- A downwards
 - B towards the North pole of the magnet
 - C towards the South pole of the magnet
 - D upwards
- 38 A nuclide of radon-222 is represented by ${}^{222}_{86}\text{Rn}$.

How many protons and how many neutrons are in a nucleus of this nuclide?

	protons	neutrons
A	86	136
B	86	222
C	222	86
D	222	136

39 A radioactive source emits three types of radiation R, S and T.

The diagram shows an experiment set up to study the penetrating properties of R, S and T.

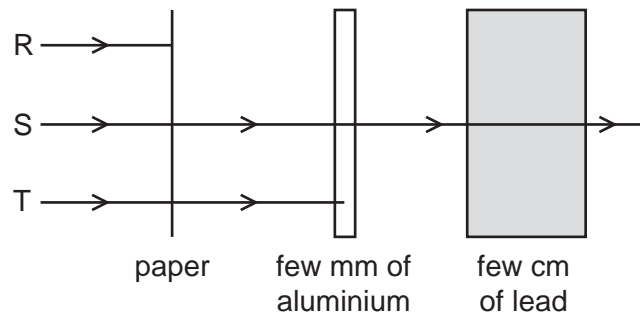

Which types of radiation are R, S and T?

	R	S	T
A	α -particles	β -particles	γ -rays
B	α -particles	γ -rays	β -particles
C	β -particles	α -particles	γ -rays
D	γ -rays	β -particles	α -particles

40 A radioactive source has a half-life of 0.5 hours.

A detector near the source shows a reading of 6000 counts per second.

Background radiation can be ignored.

What is the reading on the detector 1.5 hours later?

- A** 750 counts per second
- B** 1500 counts per second
- C** 2000 counts per second
- D** 3000 counts per second

BLANK PAGE

Permission to reproduce items where third-party owned material protected by copyright is included has been sought and cleared where possible. Every reasonable effort has been made by the publisher (UCLES) to trace copyright holders, but if any items requiring clearance have unwittingly been included, the publisher will be pleased to make amends at the earliest possible opportunity.

To avoid the issue of disclosure of answer-related information to candidates, all copyright acknowledgements are reproduced online in the Cambridge International Examinations Copyright Acknowledgements Booklet. This is produced for each series of examinations and is freely available to download at www.cie.org.uk after the live examination series.

Cambridge International Examinations is part of the Cambridge Assessment Group. Cambridge Assessment is the brand name of University of Cambridge Local Examinations Syndicate (UCLES), which is itself a department of the University of Cambridge.