



UNIVERSITY OF CAMBRIDGE INTERNATIONAL EXAMINATIONS  
International General Certificate of Secondary Education

**BIOLOGY**

**0610/11**

Paper 1 Multiple Choice

**May/June 2013**

**45 minutes**

Additional Materials: Multiple Choice Answer Sheet  
Soft clean eraser  
Soft pencil (type B or HB is recommended)

\* 2 5 2 6 7 3 7 6 7 1 \*

**READ THESE INSTRUCTIONS FIRST**

Write in soft pencil.

Do not use staples, paper clips, highlighters, glue or correction fluid.

Write your name, Centre number and candidate number on the Answer Sheet in the spaces provided unless this has been done for you.

**DO NOT WRITE IN ANY BARCODES**

There are **forty** questions on this paper. Answer **all** questions. For each question there are four possible answers **A, B, C** and **D**.

Choose the **one** you consider correct and record your choice in **soft pencil** on the separate Answer Sheet.

**Read the instructions on the Answer Sheet very carefully.**

Each correct answer will score one mark. A mark will not be deducted for a wrong answer.

Any rough working should be done in this booklet.

Electronic calculators may be used.

bestexamhelp.com

This document consists of **16** printed pages.



1 Worms come to the soil surface after heavy rain.

Which characteristic of living organisms does this show?

- A growth
- B nutrition
- C reproduction
- D sensitivity

2 Which animal is **not** an arthropod?

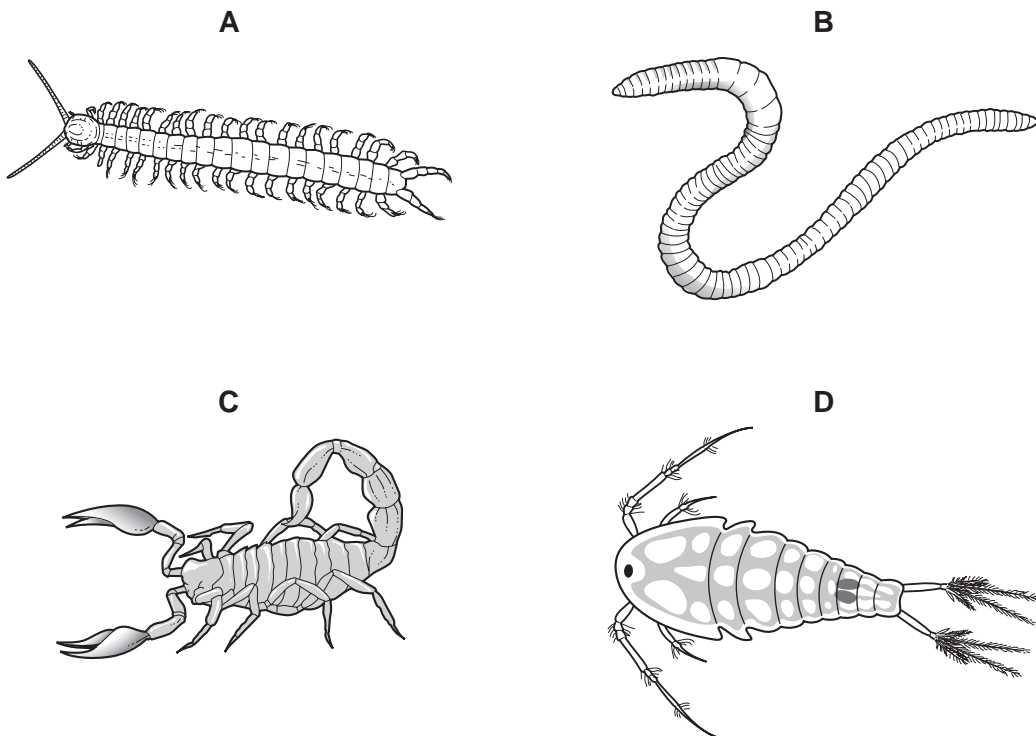

3 The diagram shows a sea lion.

Which labelled feature shows that this animal is a mammal?

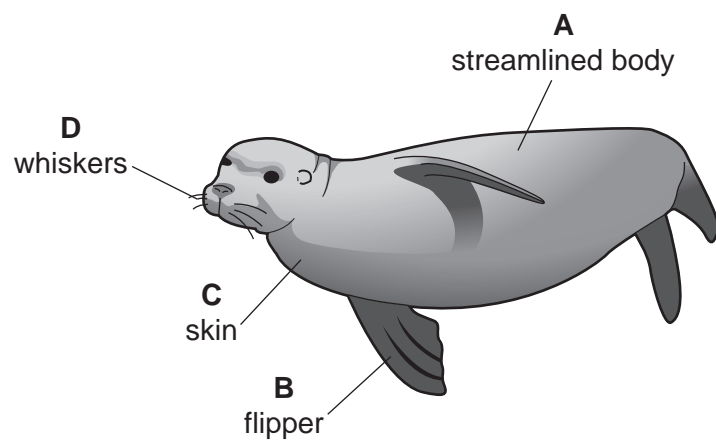

- 4 The diagram shows an animal found in fresh water.

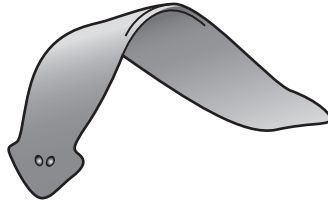

Use the key to identify the animal.

- 1 body divided into segments ..... go to 2  
 body not divided into segments ..... go to 3
- 2 straight body ..... animal **A**  
 curved body ..... animal **B**
- 3 has a shell ..... animal **C**  
 has no shell ..... animal **D**
- 5 Which statement about xylem is correct?
- A** It carries sucrose.  
**B** It converts light energy to chemical energy.  
**C** It divides actively to help the plant to grow.  
**D** It is no longer living.
- 6 The diagram shows a bacterial cell.

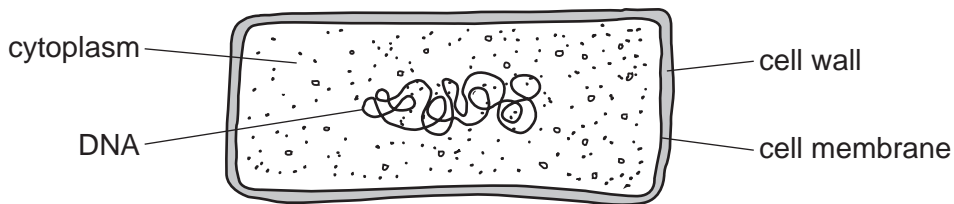

How is this cell different from a typical animal cell?

- A** It has a cell membrane.  
**B** It has cytoplasm.  
**C** It has no chloroplasts.  
**D** It has no nucleus.

7 The diagram shows a plant cell.

In which labelled part of the cell is sugar made?

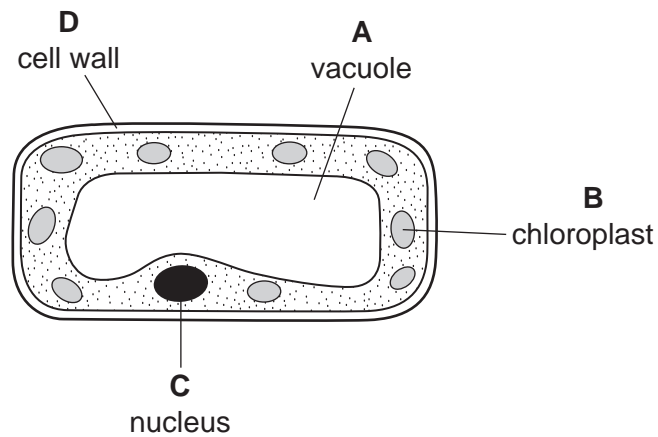

8 Which of these tissues is **not** part of the organ with which it is paired?

	tissue	organ containing this tissue
<b>A</b>	ciliated	root
<b>B</b>	muscle	intestine
<b>C</b>	nervous	brain
<b>D</b>	xylem	leaf

9 The diagram shows a specialised cell.

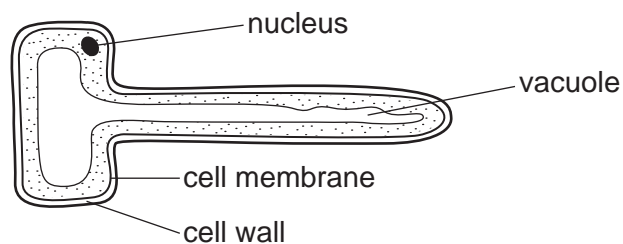

For which function is the cell adapted?

- A** absorption of water
- B** contraction of muscles
- C** movement of dust particles
- D** transport of oxygen

10 The diagram represents two liquids, separated by a membrane through which osmosis can occur.

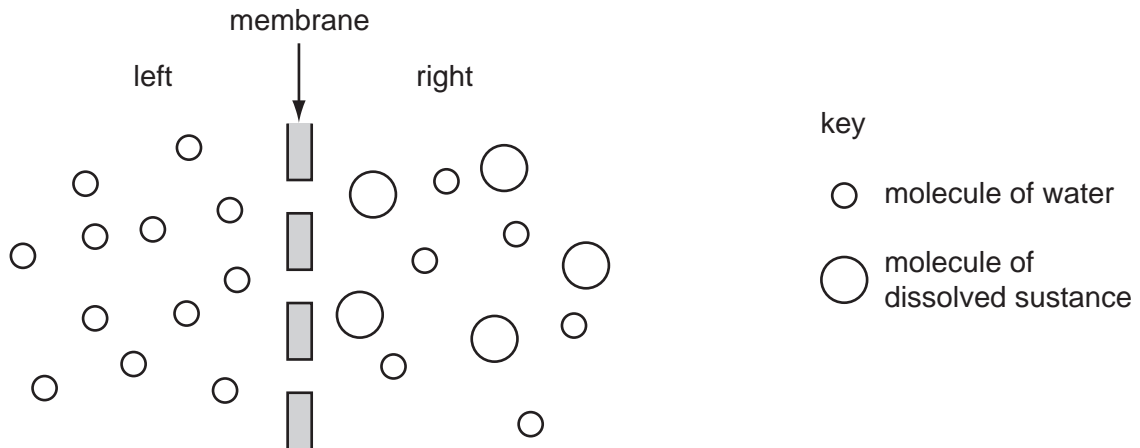

What movement of molecules will occur?

- A Molecules of dissolved substance move from left to right.
  - B Molecules of dissolved substance move from right to left.
  - C Overall, water molecules move from left to right.
  - D Overall, water molecules move from right to left.
- 11 The scent from a bunch of flowers spreads throughout a room.

How does the scent spread?

- A by conduction
  - B by diffusion
  - C by osmosis
  - D by transpiration
- 12 A human cell contains a length of DNA that carries the code for making which substance?
- A fat
  - B glycogen
  - C lipase
  - D starch

13 A student set up a test-tube containing starch, water and amylase.

How could the student test whether the amylase had digested all the starch?

- A Add Biuret solution.
- B Add dilute hydrochloric acid.
- C Add iodine solution.
- D Weigh the test-tubes and contents before and after the experiment.

14 The diagram shows the apparatus used in an investigation to measure the rate of oxygen production during photosynthesis.

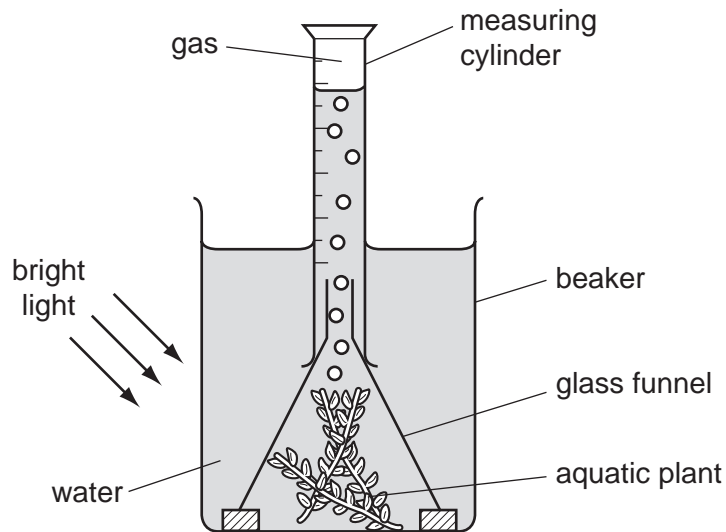

The investigation was repeated several times and the average amount of gas collected was calculated.

Which **two** factors must be kept constant during this investigation?

- A the amount of water in the beaker and the height of the measuring cylinder
- B the size of aquatic plant and the amount of gas in the measuring cylinder
- C the size of aquatic plant and the duration of exposure to light
- D the size of the beaker and the funnel

15 The diagram shows the four types of human tooth.

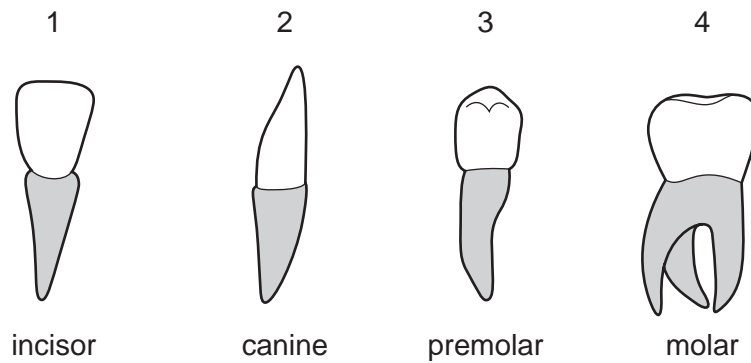

Which teeth are used for cutting rather than grinding food?

- A** 1 and 2      **B** 2 and 3      **C** 3 and 4      **D** 4 and 1

16 The diagram shows an experiment kept at room temperature.

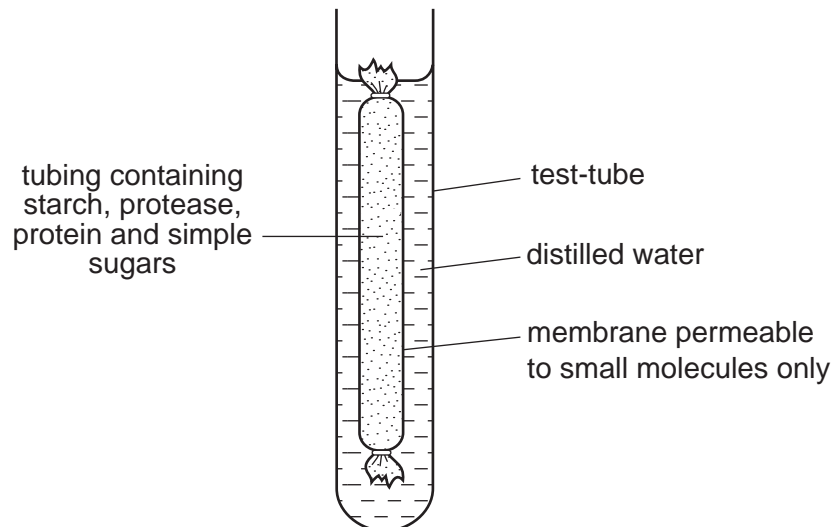

What is present in the water surrounding the membrane after 45 minutes?

- A** amino acids and simple sugars  
**B** protein and amino acids  
**C** protein and simple sugars  
**D** starch and simple sugars

17 The diagram shows a double circulatory system.

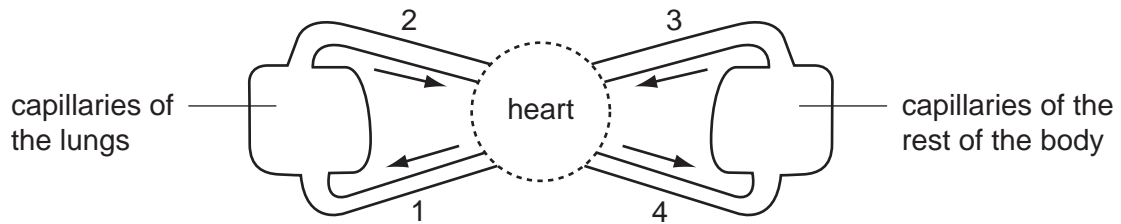

Which vessels carry oxygenated blood?

- A** 1 and 2      **B** 1 and 4      **C** 2 and 3      **D** 2 and 4

18 The photograph shows two blood cells, X and Y.

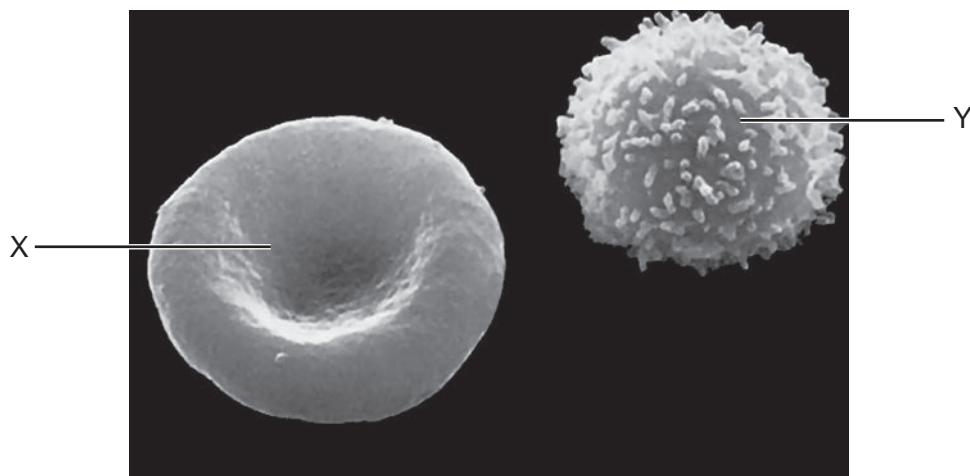

What are the functions of cells X and Y?

	cell X	cell Y
<b>A</b>	carries out phagocytosis	carries oxygen
<b>B</b>	carries oxygen	produces antibodies
<b>C</b>	carries oxygen	carries carbon dioxide
<b>D</b>	produces antibodies	carries oxygen



19 The table shows the rate of water flow through a tree over a 12 hour period.

time of day	rate of flow / cm per hour
7:00	100
9:00	120
11:00	140
13:00	250
15:00	300
17:00	260
19:00	180

What conclusion can be drawn from the table?

- A** Between 7:00 and 17:00 hours the rate of flow continuously increases.
- B** The greatest increase in rate of flow in a two-hour period is between 11:00 and 13:00 hours.
- C** Water does not flow up through a tree at night.
- D** Water flow is affected by humidity.
- 20 Which chemical could be used to show that cells are respiring aerobically?
- A** Benedict's solution
- B** dilute sulfuric acid
- C** ethanol
- D** limewater
- 21 When does respiration take place in animals and plants?

	animals	plants
<b>A</b>	all the time	all the time
<b>B</b>	all the time	night time only
<b>C</b>	day time only	day time only
<b>D</b>	day time only	night time only

22 The diagram shows some ciliated cells from the trachea.

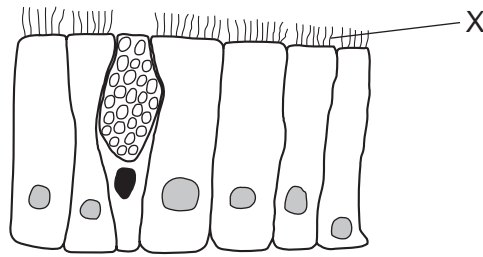

What is the function of the parts labelled X?

- A detecting stimuli
  - B exchanging gases
  - C moving mucus
  - D trapping bacteria
- 23 Which food type, when eaten in excess, will cause a rise in the urea content of urine?
- A carbohydrate
  - B fat
  - C mineral salts
  - D protein
- 24 Where is urea made?
- A intestines
  - B kidney
  - C liver
  - D muscles

- 25 The diagram shows the eye of a person in a brightly-lit room.

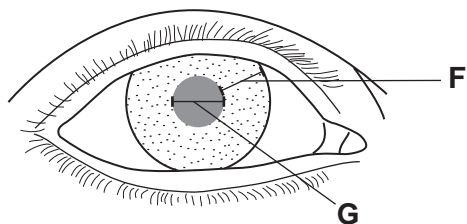

What happens to distance **F** and distance **G** when this person moves into a dimly-lit room?

	distance <b>F</b>	distance <b>G</b>
<b>A</b>	becomes larger	becomes smaller
<b>B</b>	becomes smaller	stays the same
<b>C</b>	becomes smaller	becomes larger
<b>D</b>	stays the same	becomes smaller

- 26 A boy accidentally touches a very hot object and immediately takes his hand away.

In this reflex action, what is the effector?

- A** a heat receptor in his hand  
**B** a motor neurone  
**C** a muscle in his arm  
**D** the spinal cord
- 27 Which row shows how one type of gamete is transported so that fertilisation can occur in a flowering plant?

	type of gamete	how transported
<b>A</b>	female	in a pollen grain
<b>B</b>	female	in a seed
<b>C</b>	male	in a pollen grain
<b>D</b>	male	in a seed

28 In which conditions will seeds germinate?

	temperature / °C	the only gas present	water
<b>A</b>	20	carbon dioxide	water present
<b>B</b>	20	oxygen	water present
<b>C</b>	0	carbon dioxide	water absent
<b>D</b>	0	oxygen	water absent

29 The graph shows the growth curves for boys and girls.

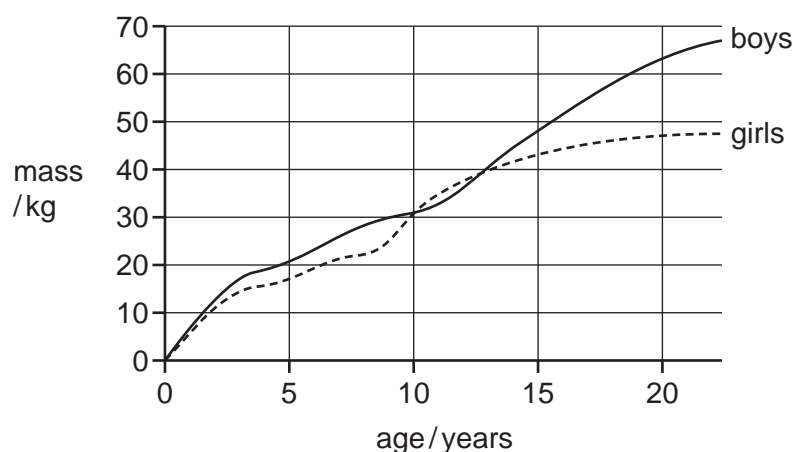

What is the approximate average growth rate of boys between 10 and 15 years old?

- A** 3.5 kg per year
- B** 18 kg per year
- C** 32 kg per year
- D** 50 kg per year

30 In cats, the allele for short hair is dominant to the allele for long hair. A short-haired cat gives birth to five kittens. Two of them have long hair.

Which statement **must** be correct?

- A** Neither of the parents is heterozygous.
- B** One parent is homozygous.
- C** The female cat is heterozygous.
- D** The male cat is heterozygous.

31 Cystic fibrosis is an inherited disease that occurs when an individual is homozygous for a recessive allele.

If parents are both heterozygous for this characteristic, what is the probability that their first child will have cystic fibrosis?

- A 0%                      B 25%                      C 50%                      D 100%

32 What determines the sex of a baby?

- A the father's blood group
- B the father's chromosomes
- C the mother's blood group
- D the mother's chromosomes

33 Which statement explains why the energy flow in a food chain is in one direction?

- A Decomposers recycle nutrients for plants.
- B Energy is not recycled.
- C Plants convert light energy to chemical energy.
- D The number of organisms decreases at each level in the food chain.

34 Which organisms do **not** get their energy by eating other organisms?

- A consumer
- B decomposer
- C herbivore
- D producer

35 A single tree is food for a large population of caterpillars. Several small birds eat the caterpillars. The small birds are eaten by a bird of prey.

Which is the pyramid of biomass?

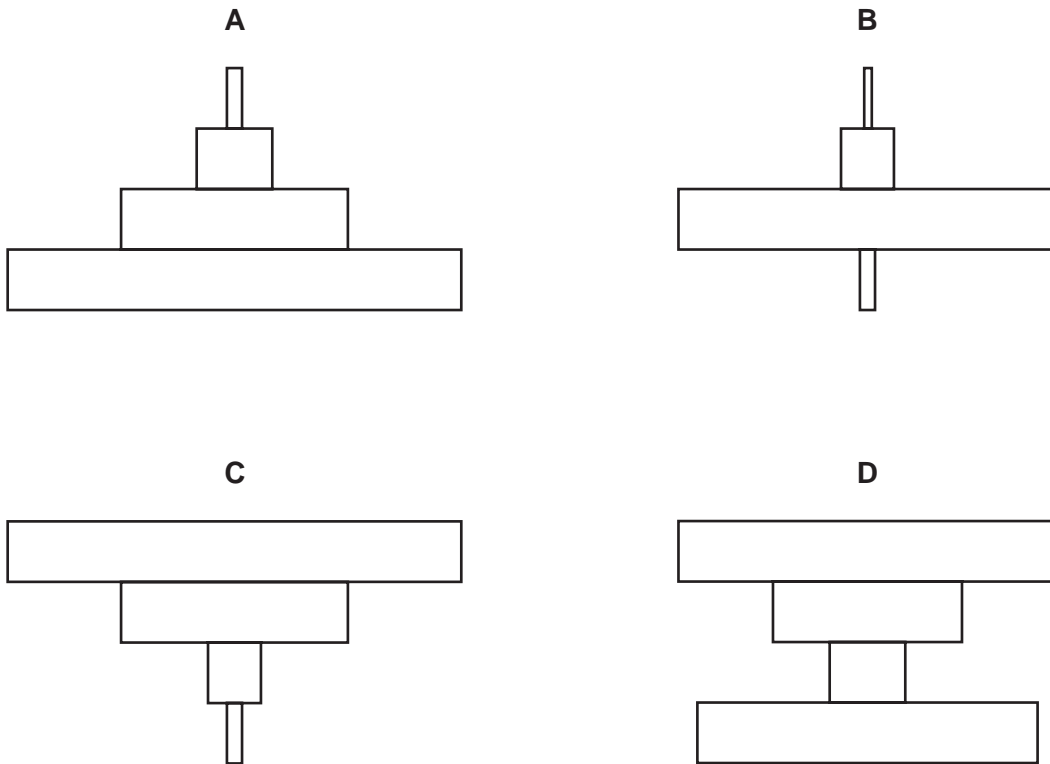

36 The diagram shows part of the carbon cycle.

Which letter represents photosynthesis?

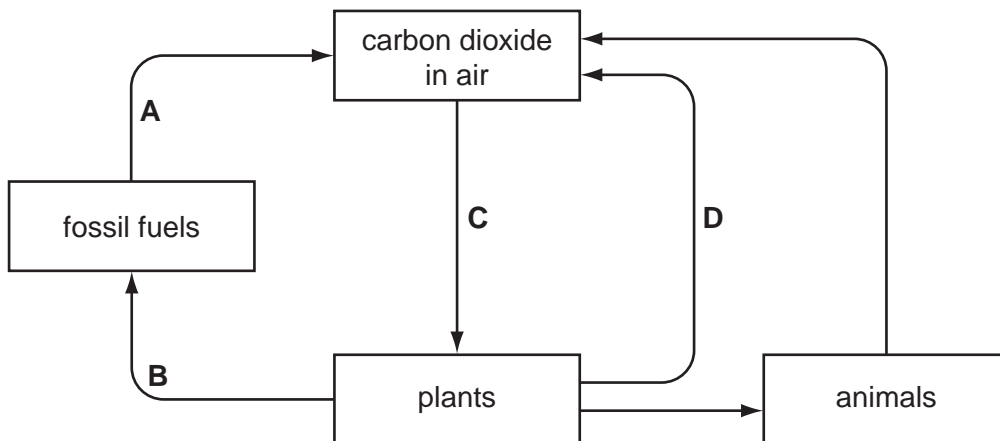

37 The diagram shows part of the water cycle.

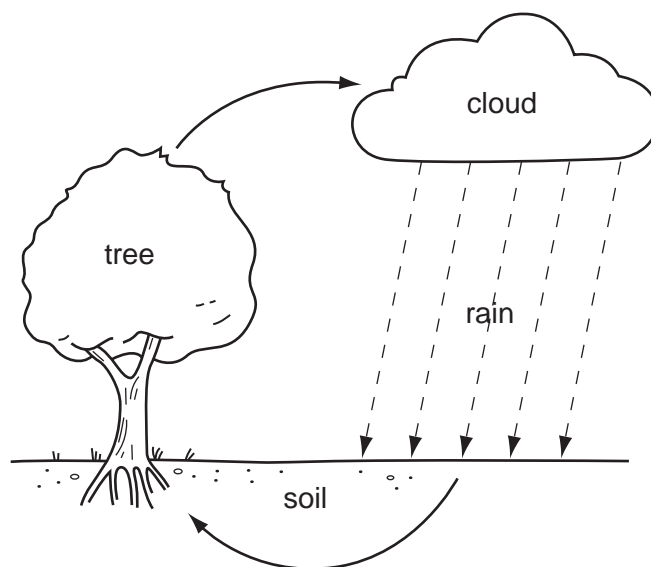

How is water lost from the tree?

- A condensation
- B respiration
- C translocation
- D transpiration

38 Rabbits eat grass and foxes eat rabbits.

What would cause the highest increase in the number of rabbits?

- A less grass and fewer foxes
- B less grass and more foxes
- C more grass and fewer foxes
- D more grass and more foxes

39 The bloodworm is found in heavily polluted water.

The diagram shows where raw sewage flows into a river.

Where would there be fewest bloodworms?

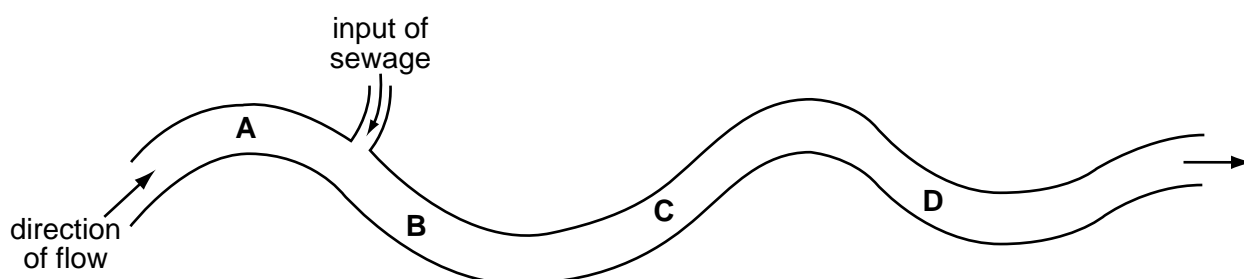

40 What describes eutrophication and its effect on a river?

- A Nutrients are depleted in the river, causing bacteria to die. This allows plants to grow and deoxygenate the water.
- B Nutrients are depleted in the river, causing plants to die. These decompose, so the water is deoxygenated.
- C Nutrients enter the river, causing algae to grow. These die and decompose, so the water is deoxygenated.
- D Nutrients enter the river, causing plants to grow. These provide extra food for animals, which deoxygenate the water.

---

Permission to reproduce items where third-party owned material protected by copyright is included has been sought and cleared where possible. Every reasonable effort has been made by the publisher (UCLES) to trace copyright holders, but if any items requiring clearance have unwittingly been included, the publisher will be pleased to make amends at the earliest possible opportunity.

University of Cambridge International Examinations is part of the Cambridge Assessment Group. Cambridge Assessment is the brand name of University of Cambridge Local Examinations Syndicate (UCLES), which is itself a department of the University of Cambridge.