



UNIVERSITY OF CAMBRIDGE INTERNATIONAL EXAMINATIONS  
International General Certificate of Secondary Education

CANDIDATE  
NAME

CENTRE  
NUMBER

--	--	--	--	--

CANDIDATE  
NUMBER

--	--	--	--

**BIOLOGY**

**0610/32**

Paper 3 Extended

**May/June 2012**

**1 hour 15 minutes**

Candidates answer on the Question Paper.

No Additional Materials are required.



**READ THESE INSTRUCTIONS FIRST**

Write your Centre number, candidate number and name on all the work you hand in.

Write in dark blue or black pen.

You may use a pencil for any diagrams or graphs.

Do not use staples, paper clips, highlighters, glue or correction fluid.

**DO NOT WRITE IN ANY BARCODES.**

Answer **all** questions.

At the end of the examination, fasten all your work securely together.

The number of marks is given in brackets [ ] at the end of each question or part question.

For Examiner's Use	
1	
2	
3	
4	
5	
6	
<b>Total</b>	

This document consists of **17** printed pages and **3** blank pages.





- 1 Fig. 1.1 **A** shows a cell from the lining of the alimentary canal.  
 Fig. 1.1 **B** shows a cell from the lining of a kidney tubule.  
 Both cells absorb substances into the blood.

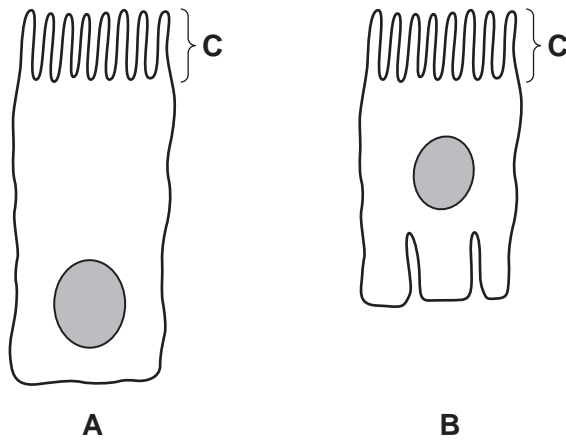

Fig. 1.1

- (a) Name the structures labelled **C** on the cells in Fig. 1.1.

..... [1]

- (b) List three substances that are absorbed by **both** cells shown in Fig. 1.1.

1 .....  
 2 .....  
 3 ..... [3]

- (c) Explain how **both** cells shown in Fig. 1.1 are adapted for absorption of substances into the blood.

.....  
 .....  
 .....  
 .....  
 ..... [2]

- (d) Name the part of the alimentary canal that is lined by the cells shown in Fig. 1.1 **A**.

..... [1]

[Total: 7]

2 (a) Define the term *growth*.

.....

.....

.....

..... [2]

Some students investigated the responses of tomato seedlings to receiving light from one side (unidirectional light).

The students germinated tomato seeds in the dark and then placed the seedlings in test-tubes with water. The seedlings were treated in four different ways, **E** to **H**, as shown in Fig. 2.1. The responses of the seedlings are shown in Fig. 2.2.

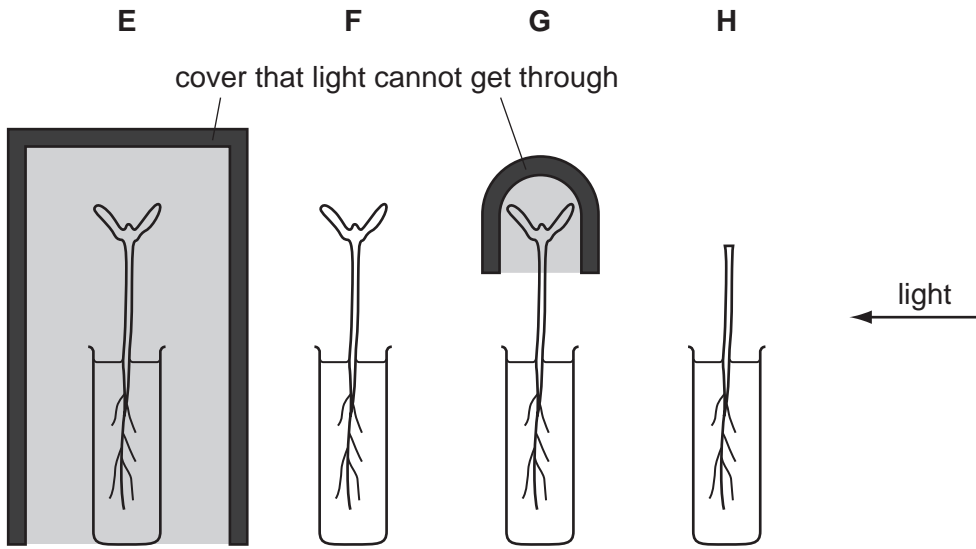

Fig. 2.1

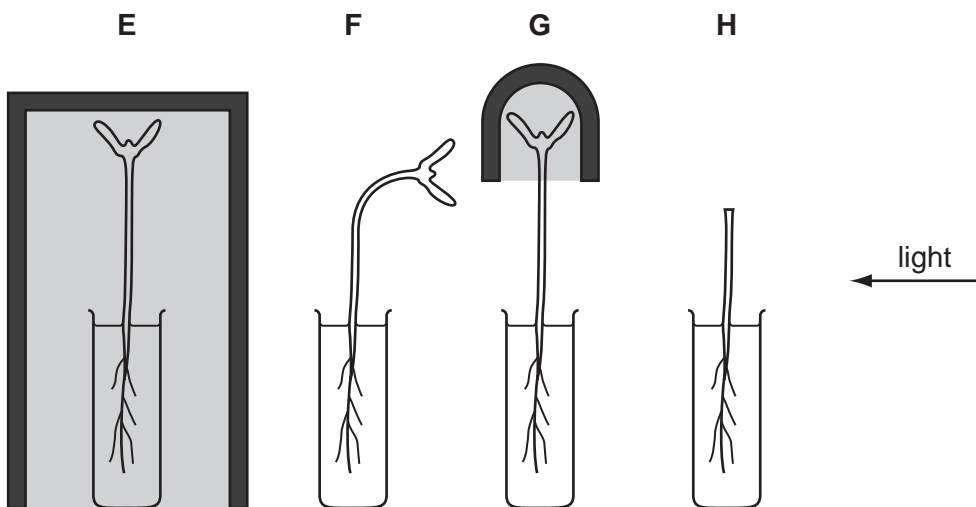

Fig. 2.2

(b) Name the response shown by the tomato seedling, **F**, which has bent 90° towards the light.

..... [2]

(c) Using the results shown in Fig. 2.2, suggest what conclusions may be made about how the tomato seedlings detected the stimulus of unidirectional light. You may refer to the seedlings by the letters **E** to **H**.

.....  
.....  
.....  
.....  
.....  
.....  
.....  
.....  
.....  
.....  
..... [3]

(d) Explain the advantage of the response shown by seedlings to unidirectional light.

.....  
.....  
.....  
.....  
..... [2]

(e) Responses to light are coordinated by plant growth substances known as auxins. Explain the role of auxins in coordinating the response.

.....  
.....  
.....  
.....  
..... [2]

- (f) Research workers in India tested the hypothesis that pigments in tomato seedlings detect blue light. They used a variety of tomato seedling that does **not** have the ability to make a certain pigment.

For  
Examiner's  
Use

These seedlings and a control group of seedlings were grown in the dark and then exposed to unidirectional blue light for 360 minutes.

The scientists measured the degree of bending of the seedlings at intervals during the 360 minutes. Their results are shown in Fig. 2.3.

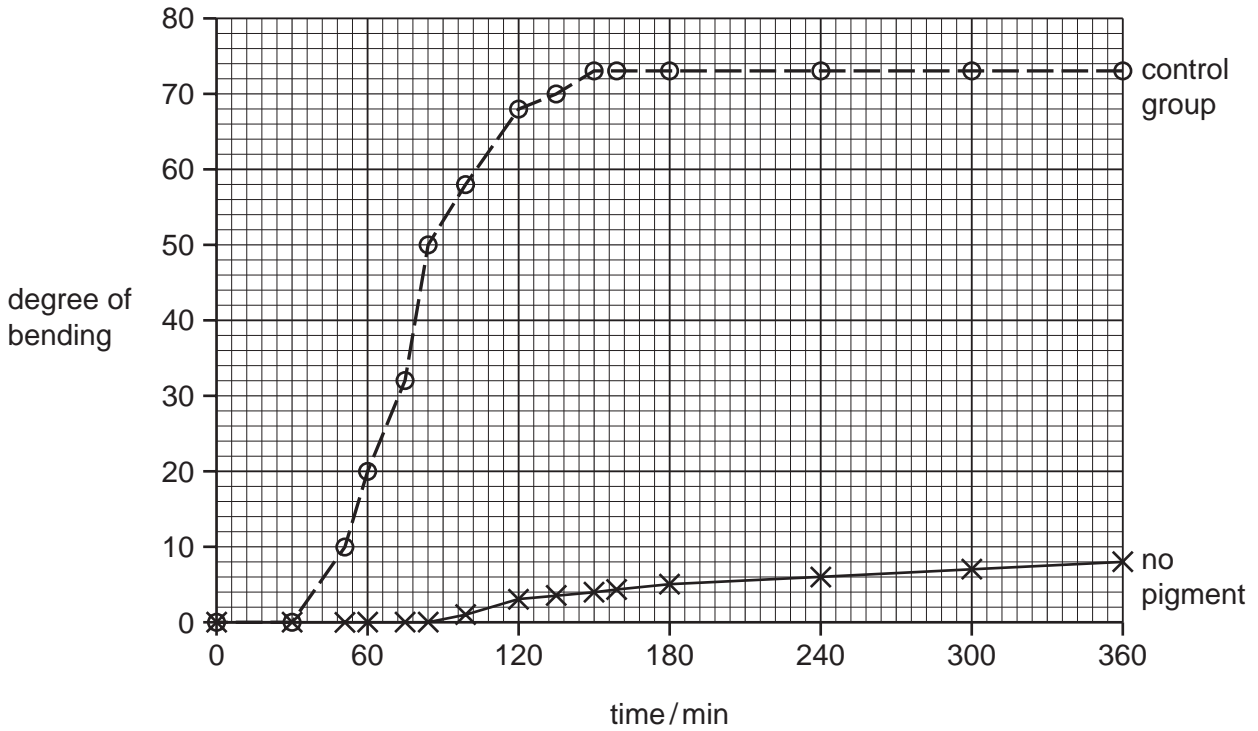

**Fig. 2.3**

- (i) Describe the results shown in Fig. 2.3.

.....

.....

.....

.....

.....

.....

.....

.....

.....

.....

..... [4]

(ii) Suggest an explanation for the differences between the responses of the two groups of seedlings.

*For  
Examiner's  
Use*

.....

.....

.....

.....

.....

..... [2]

[Total: 17]

- 3 The red slender loris, *Loris tardigradus*, is a nocturnal mammal that feeds at night on flowers, fruit and a variety of small animals. It is found in forest ecosystems in South Asia.

For  
Examiner's  
Use

Fig. 3.1 shows a red slender loris.



Fig. 3.1

- (a) Explain the meaning of the term *ecosystem*.

.....  
.....  
.....  
..... [2]

- (b) State three ways in which mammals, such as the red slender loris, differ from other groups of vertebrates.

1 .....  
2 .....  
3 ..... [3]



(c) The large eyes of the red slender loris show that it is well adapted for a nocturnal way of life.

Suggest other features that the animal is likely to have that are adaptations to being active at night.

.....  
.....  
.....  
.....  
..... [2]

Two species of slender loris are found in Sri Lanka, the grey slender loris, *L. lydekkerianus*, and *L. tardigradus*.

The International Union for Conservation of Nature describes the red slender loris as endangered. Horton Plains National Park in Sri Lanka is one of the few places where *L. tardigradus* is found.

(d) Discuss why areas of land, such as the Horton Plains National Park, must be conserved.

.....  
.....  
.....  
.....  
.....  
.....  
.....  
..... [4]

(e) State how scientists could show that two populations of slender loris belong to the same species or to two different species.

.....  
.....  
..... [1]

[Total: 12]

4 Fig. 4.1 shows a vertical section of a human heart.

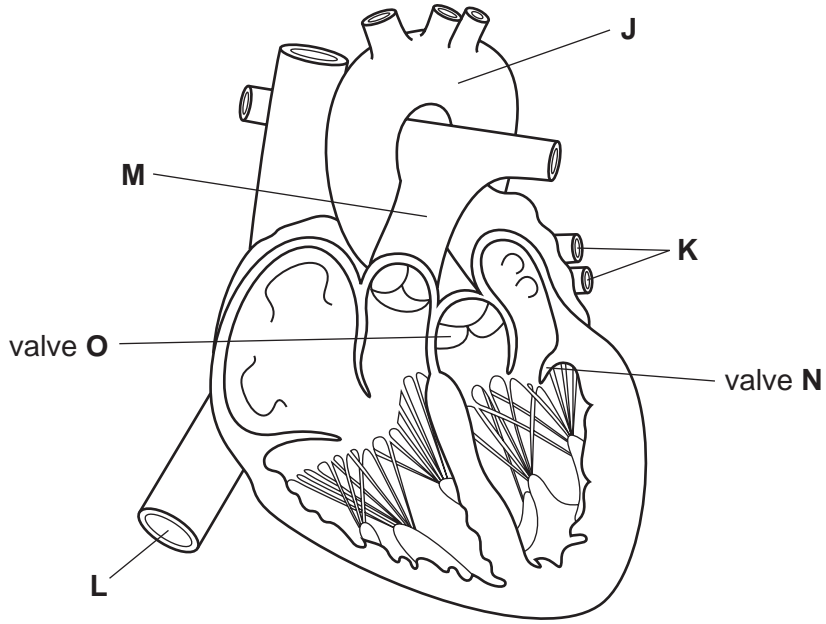

Fig. 4.1

(a) Identify the blood vessels labelled J to M.

- J .....
- K .....
- L .....
- M ..... [4]

- (b) Sensors that detect changes in blood pressure were placed into the blood vessels surrounding the heart. Recordings were taken at the times when the ventricles contracted and when they relaxed.

The blood pressures recorded are shown in Table 4.1.

**Table 4.1**

blood vessel	blood pressure / kPa	
	contraction of the ventricles	relaxation of the ventricles
<b>J</b>	16.0	10.0
<b>K</b>	0.3	0.3
<b>L</b>	0.3	0.3
<b>M</b>	2.0	0.5

- (i) Explain why the pressure in blood vessel **J** is greater than the pressure in blood vessel **M**.

.....

.....

.....

.....

..... [2]

- (ii) Explain why the pressure in blood vessels **K** and **L** is much less than the pressure in blood vessels **J** and **M**.

.....

.....

.....

..... [2]

(c) Explain how the valves at **N** and **O** maintain one-way flow of blood through the heart.

.....  
.....  
.....  
.....  
.....  
.....  
.....  
..... [4]

(d) Other than in the heart, state where valves similar to those at **O** are found in the circulatory system.

.....  
..... [1]

[Total: 13]

5 Fig. 5.1 shows the human male reproductive system and part of the urinary system.

For  
Examiner's  
Use

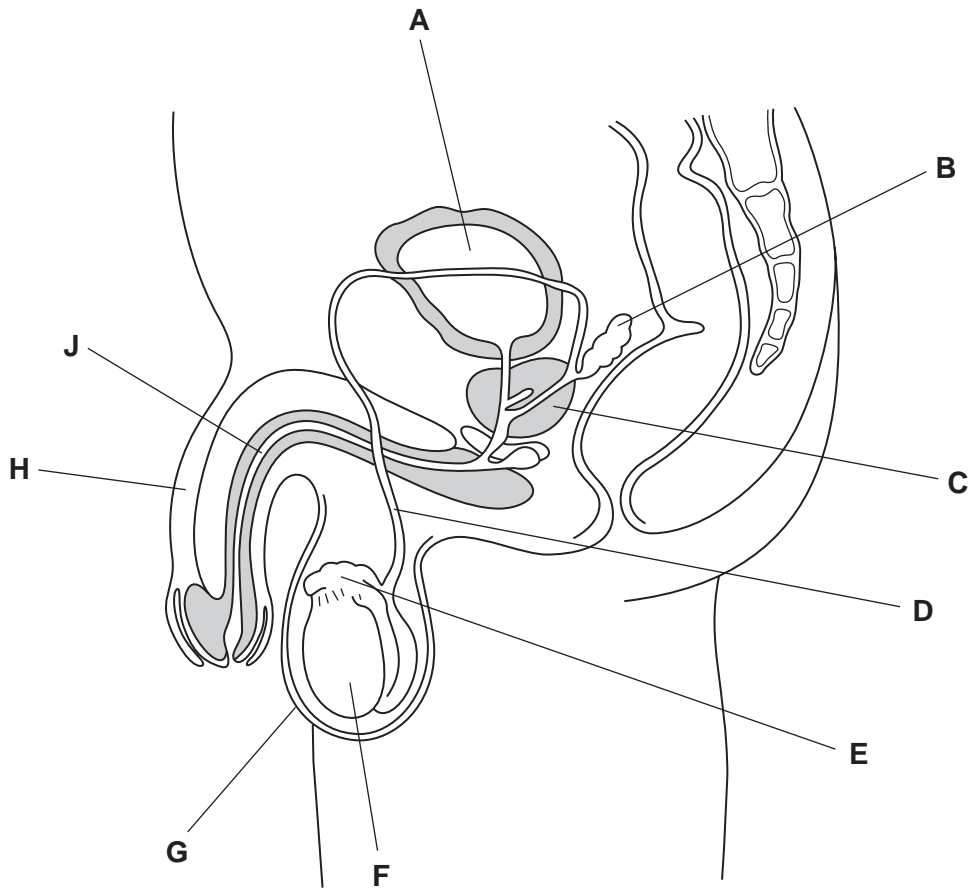

Fig. 5.1

(a) Complete Table 5.1 by identifying the structure in the male reproductive system shown in Fig. 5.1 that carries out each of the functions listed.

Write one letter only in each box. You may use the same letter more than once. There are some letters that you will not use. The first one has been done for you.

Table 5.1

function	structure
stores urine	<b>A</b>
produces gametes	
produces seminal fluid	
moves gametes by peristalsis	
produces testosterone	

[4]

**(b)** Describe how human male gametes differ from human female gametes.

.....  
.....  
.....  
.....  
.....  
.....  
.....  
.....  
.....  
..... [4]

**(c)** Some women have difficulty becoming pregnant. They can be helped by taking fertility drugs. They can also be helped by artificial insemination.

**(i)** Describe how fertility drugs help women to become pregnant.

.....  
.....  
.....  
.....  
.....  
..... [3]

**(ii)** Describe how artificial insemination is carried out.

.....  
.....  
.....  
..... [2]

[Total: 13]

- 6 Nitrogen gas makes up about 80 % of the Earth's atmosphere. Only those organisms that are able to fix nitrogen can use it. All other organisms rely on the recycling of nitrogen from nitrogen-containing compounds, such as proteins and DNA. Fig. 6.1 shows the nitrogen cycle on a small farm in Ghana.

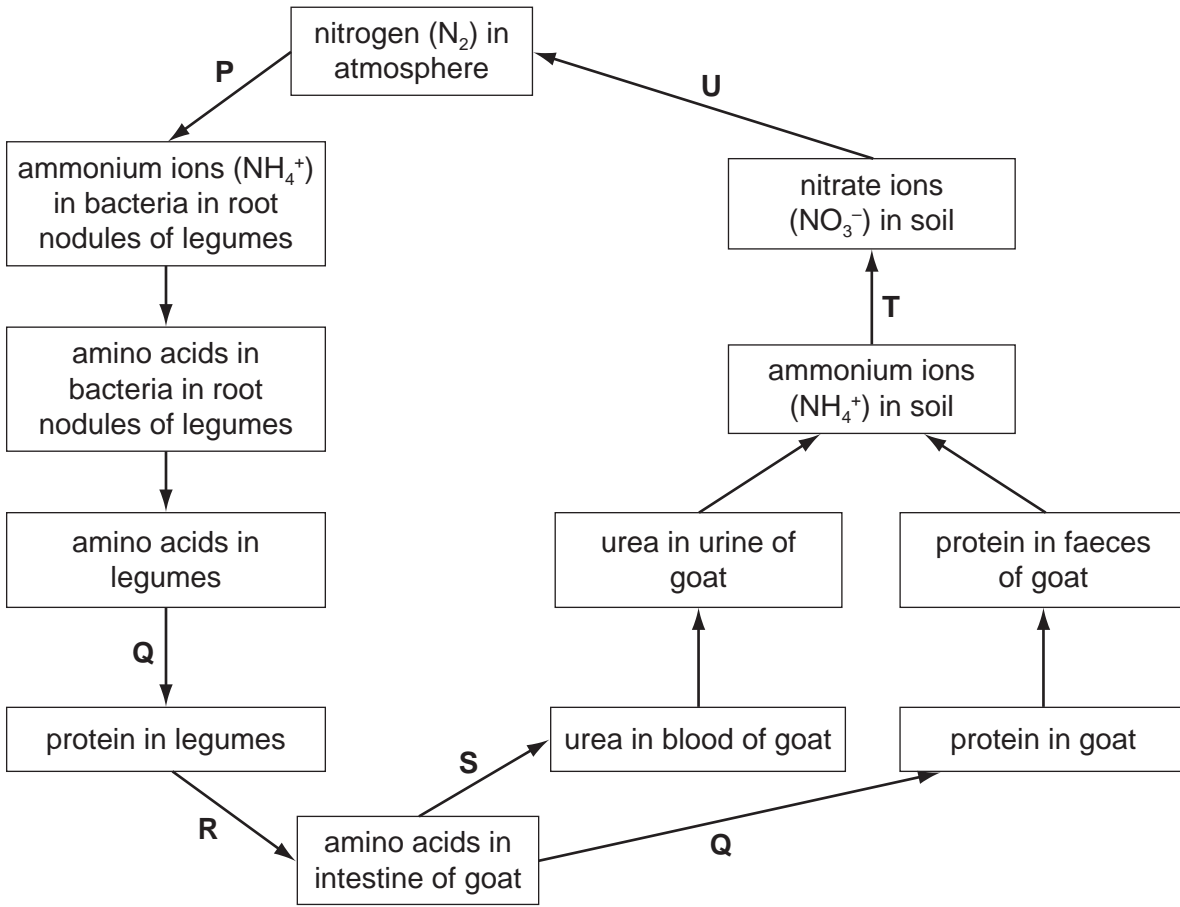

Fig. 6.1

- (a) Complete Table 6.1 by identifying the processes, P to U, in the nitrogen cycle shown in Fig. 6.1.

One process, S, has been completed for you.

Table 6.1

stage	process
P	
Q	
R	
S	deamination
T	
U	

[5]

It is difficult to improve legume crops by traditional plant breeding methods. Scientists in Ghana have used a different approach. They exposed seeds of two varieties of winged bean, *Psophocarpus tetragonolobus*, to ionising radiation.

For  
Examiner's  
Use

Seeds that had been exposed to radiation (irradiated seeds) and seeds that had not been irradiated were grown under identical conditions.

After 45 days, the numbers of root nodules on the plants that grew from these seeds were recorded. The dry mass of the root nodules on each plant was also determined and recorded.

The results of the investigation are shown in Table 6.2.

**Table 6.2**

feature	variety 1		variety 2	
	non-irradiated	irradiated	non-irradiated	irradiated
mean number of nodules per plant at 45 days	12	21	7	21
mean dry mass of nodules per plant at 45 days / g	0.09	0.21	0.14	0.24

**(b)** Use the results in Table 6.2 to describe the effect of radiation on the plants in both varieties.

.....

.....

.....

.....

.....

.....

..... [3]



(c) Suggest and explain what happens to the seeds when they are exposed to ionising radiation.

.....  
.....  
.....  
..... [2]

(d) Researchers use plants that show useful features in selective breeding to improve varieties of the winged bean. The improvement of winged beans by selective breeding is an example of artificial selection.

Suggest how selective breeding is carried out with plants.

.....  
.....  
.....  
.....  
.....  
.....  
.....  
..... [4]

(e) Scientists in Australia have put a gene from the bacterium *Bacillus thuringiensis* (Bt) into the cowpea, an important crop in Africa. This gene gives resistance against the cowpea pod borer, an insect pest that reduces the yield of cowpeas.

Explain how the method used by the Australian scientists differs from the technique used by the Ghanaian scientists.

.....  
.....  
.....  
..... [2]

- (f) Legumes, such as cowpeas and winged beans, are grown in between maize plants in a method known as intercropping.

Suggest the advantages to farmers of growing legumes and maize together in the same field at the same time.

.....

.....

.....

..... [2]

[Total: 18]

*For  
Examiner's  
Use*



**BLANK PAGE**

---

Permission to reproduce items where third-party owned material protected by copyright is included has been sought and cleared where possible. Every reasonable effort has been made by the publisher (UCLES) to trace copyright holders, but if any items requiring clearance have unwittingly been included, the publisher will be pleased to make amends at the earliest possible opportunity.

University of Cambridge International Examinations is part of the Cambridge Assessment Group. Cambridge Assessment is the brand name of University of Cambridge Local Examinations Syndicate (UCLES), which is itself a department of the University of Cambridge.